



US00D876958S

(12) **United States Design Patent**
Carle

(10) **Patent No.:** **US D876,958 S**
(45) **Date of Patent:** **** Mar. 3, 2020**

(54) **TISSUE BOX**

D424,851 S * 5/2000 Smith D6/515
D514,437 S * 2/2006 Kim D9/416
D528,435 S * 9/2006 Keberlein D9/734

(Continued)

(71) Applicant: **Violeta Carle**, Stirling (AU)

Primary Examiner — Lauren R Calve

(72) Inventor: **Violeta Carle**, Stirling (AU)

(74) *Attorney, Agent, or Firm* — Maschoff Brennan

(73) Assignee: **Violeta Carle**, Stirling (AU)

(57) **CLAIM**

(**) Term: **15 Years**

The ornamental design for a tissue box, as shown and described.

(21) Appl. No.: **29/628,583**

DESCRIPTION

(22) Filed: **Dec. 6, 2017**

FIG. 1 is a first side view of an embodiment of a tissue box; FIG. 2 is a top view of the tissue box shown in FIG. 1; FIG. 3 is a second side view of the tissue box shown in FIG. 1;

(30) **Foreign Application Priority Data**

Jun. 7, 2017 (AU) 201713405
Jun. 7, 2017 (AU) 201713411

FIG. 4 is a bottom view of the tissue box shown in FIG. 1; FIG. 5 is a third side view of the tissue box shown in FIG. 1;

(51) **LOC (12) Cl.** **09-01**

(52) **U.S. Cl.**
USPC **D9/734**

FIG. 6 is a fourth side view of the tissue box shown in FIG. 1;

(58) **Field of Classification Search**

USPC D9/414, 416, 432, 433, 730, 734;
D6/515, 518, 519, 521, 522, 523;
D7/601, 602, 631

FIG. 7 is a first perspective view of the tissue box shown in FIG. 1;

CPC B65D 85/00; B65D 81/00; B65D 81/22;
B65D 83/0805; A47K 2010/3266; A47K
10/42; A47K 10/426; G07F 11/00

FIG. 8 is a second perspective view of the tissue box shown in FIG. 1;

See application file for complete search history.

FIG. 9 is a first side view of another embodiment of a tissue box;

(56) **References Cited**

U.S. PATENT DOCUMENTS

D209,336 S * 11/1967 Dykes et al. D9/414
D209,337 S * 11/1967 Dykes et al. D9/414
D277,169 S * 1/1985 Ito D9/432
D297,774 S * 9/1988 Sussman D28/76
5,002,200 A * 3/1991 Hunt A47F 13/085
206/554
D376,501 S * 12/1996 Spaseska D6/518

FIG. 10 is a second side view of the tissue box shown in FIG. 9;

FIG. 11 is a top view of the tissue box shown in FIG. 9;

FIG. 12 is a bottom view of the tissue box shown in FIG. 9;

FIG. 13 is a third side view of the tissue box shown in FIG. 9;

FIG. 14 is a fourth side view of the tissue box shown in FIG. 9;

FIG. 15 is a first perspective view of the tissue box shown in FIG. 9; and,

FIG. 16 is a second perspective view of the tissue box shown in FIG. 9.

1 Claim, 16 Drawing Sheets

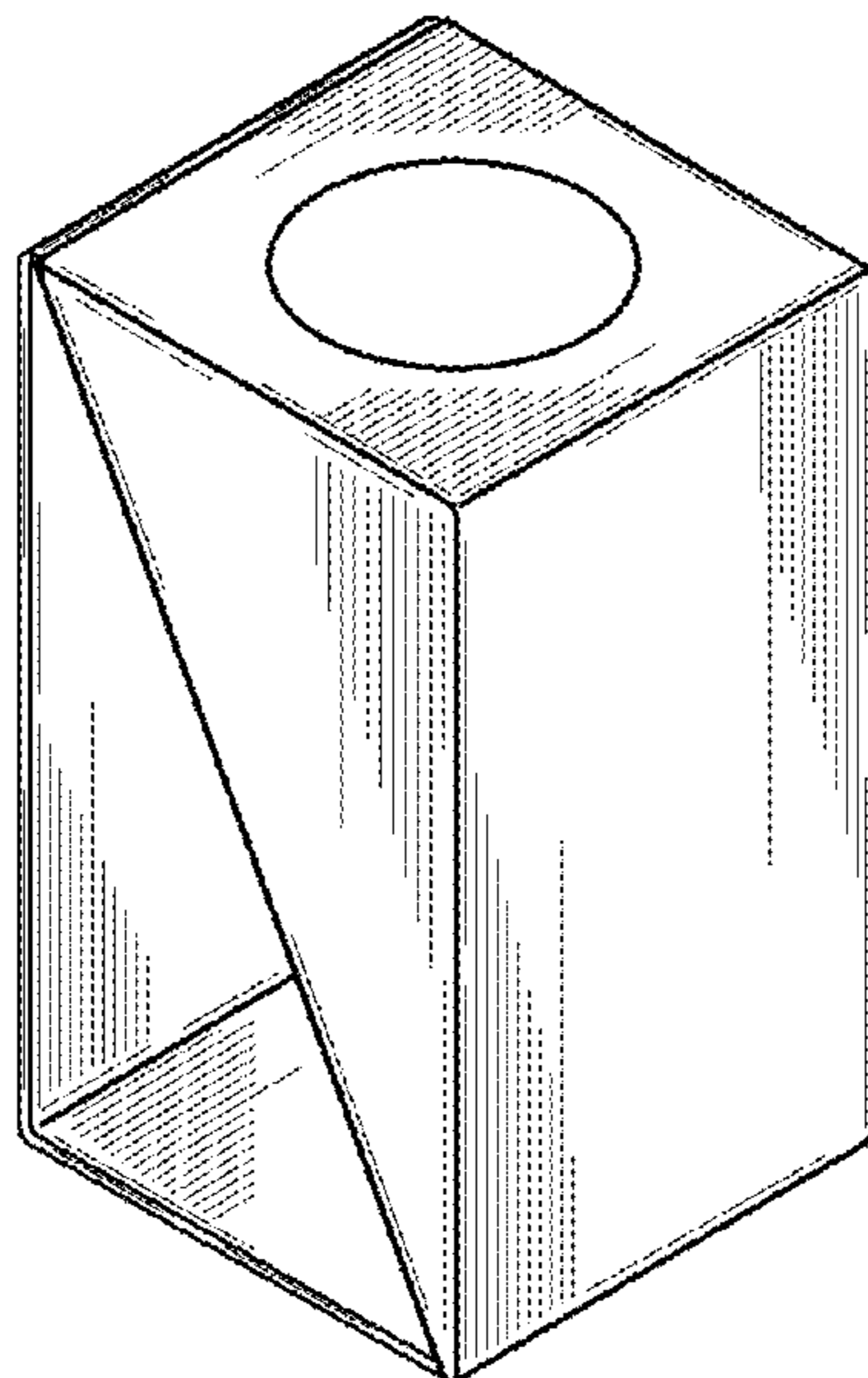

(56)

References Cited

U.S. PATENT DOCUMENTS

D578,021	S *	10/2008	Reinsel	D9/734
D664,041	S *	7/2012	Fauerbach	D9/432
D702,565	S *	4/2014	Gale	D9/734
D712,750	S *	9/2014	Glenn	D9/734
D718,149	S *	11/2014	Glenn	D9/734
8,960,494	B1 *	2/2015	Gluck	B65D 83/0805
				221/101
D735,488	S *	8/2015	Page	D6/518
D756,146	S *	5/2016	Green	D6/518
D759,503	S *	6/2016	Terpko	D6/515
2004/0060941	A1 *	4/2004	Middione	B65D 83/0888
				220/661
2008/0110918	A1 *	5/2008	Lee	A47K 10/3818
				221/45
2008/0223867	A1 *	9/2008	Carr	A47K 10/421
				221/34
2013/0112584	A1 *	5/2013	Gaspari	B65D 83/0805
				206/494
2014/0312049	A1 *	10/2014	Glenn	A47K 10/426
				221/63
2016/0288985	A1 *	10/2016	Aguilar	B65D 83/0888
2018/0086496	A1 *	3/2018	Etem	B65D 5/4287
2018/0148216	A1 *	5/2018	Stephens	B65D 5/542

* cited by examiner

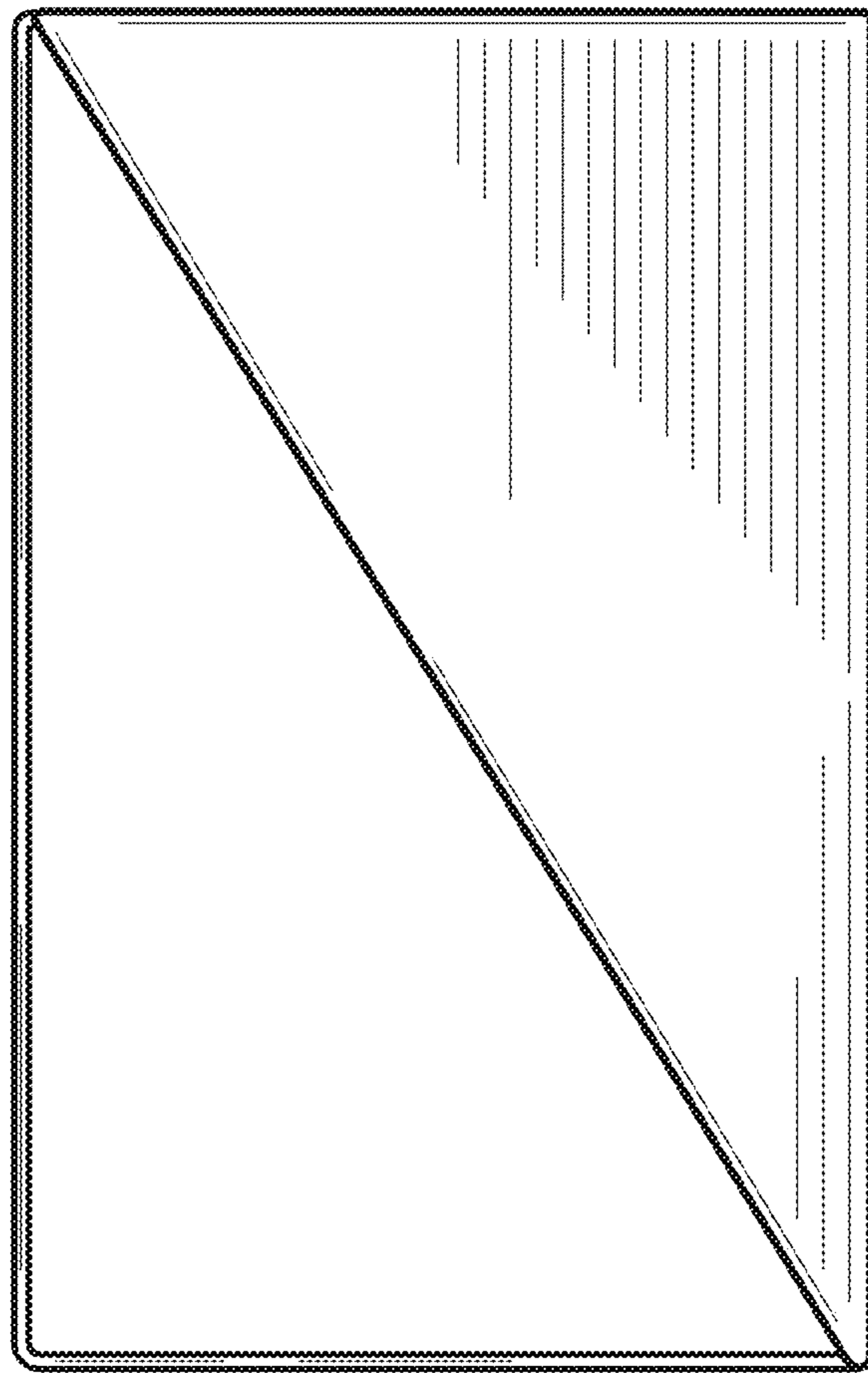

FIG. 1

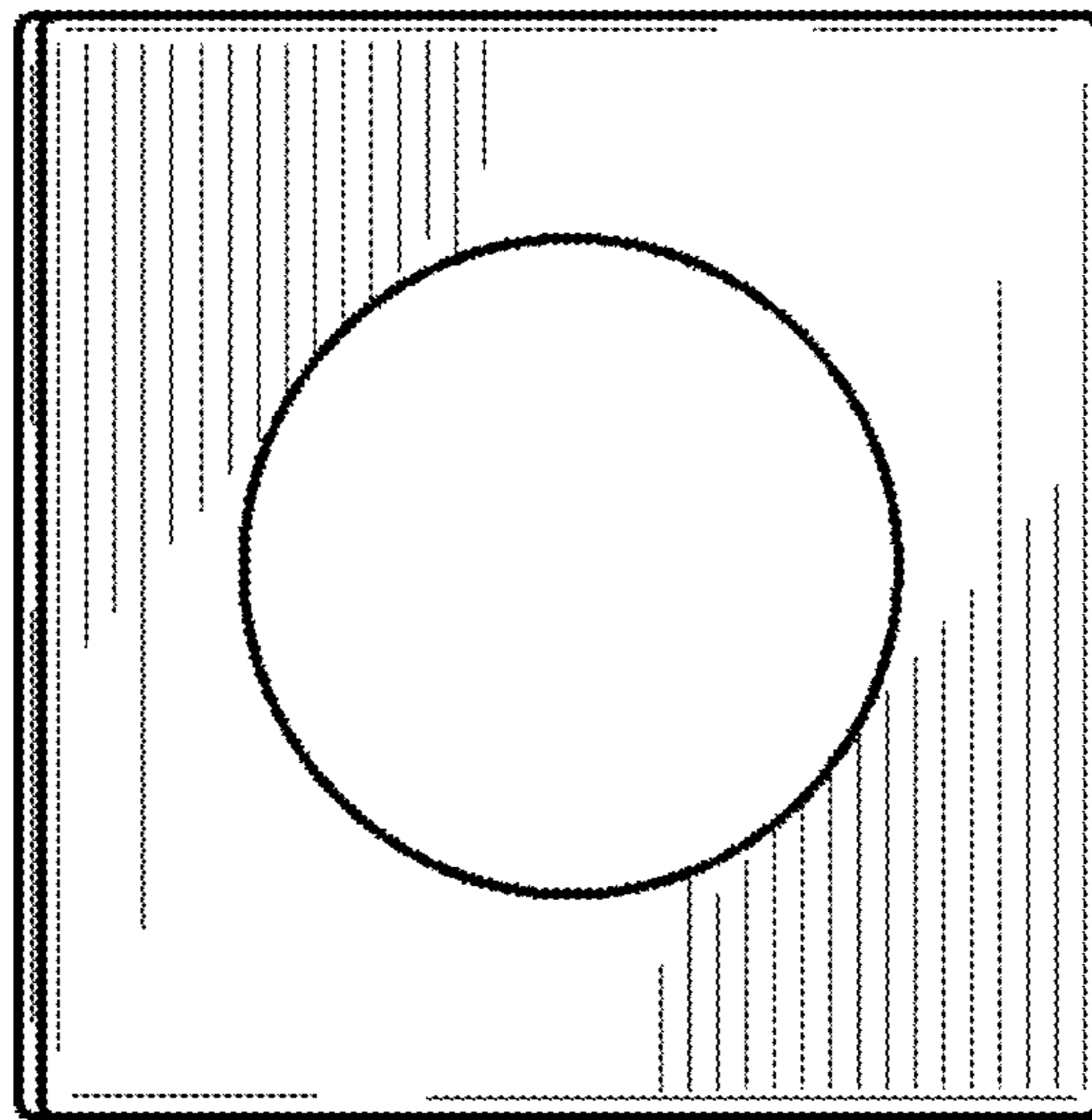

FIG. 2

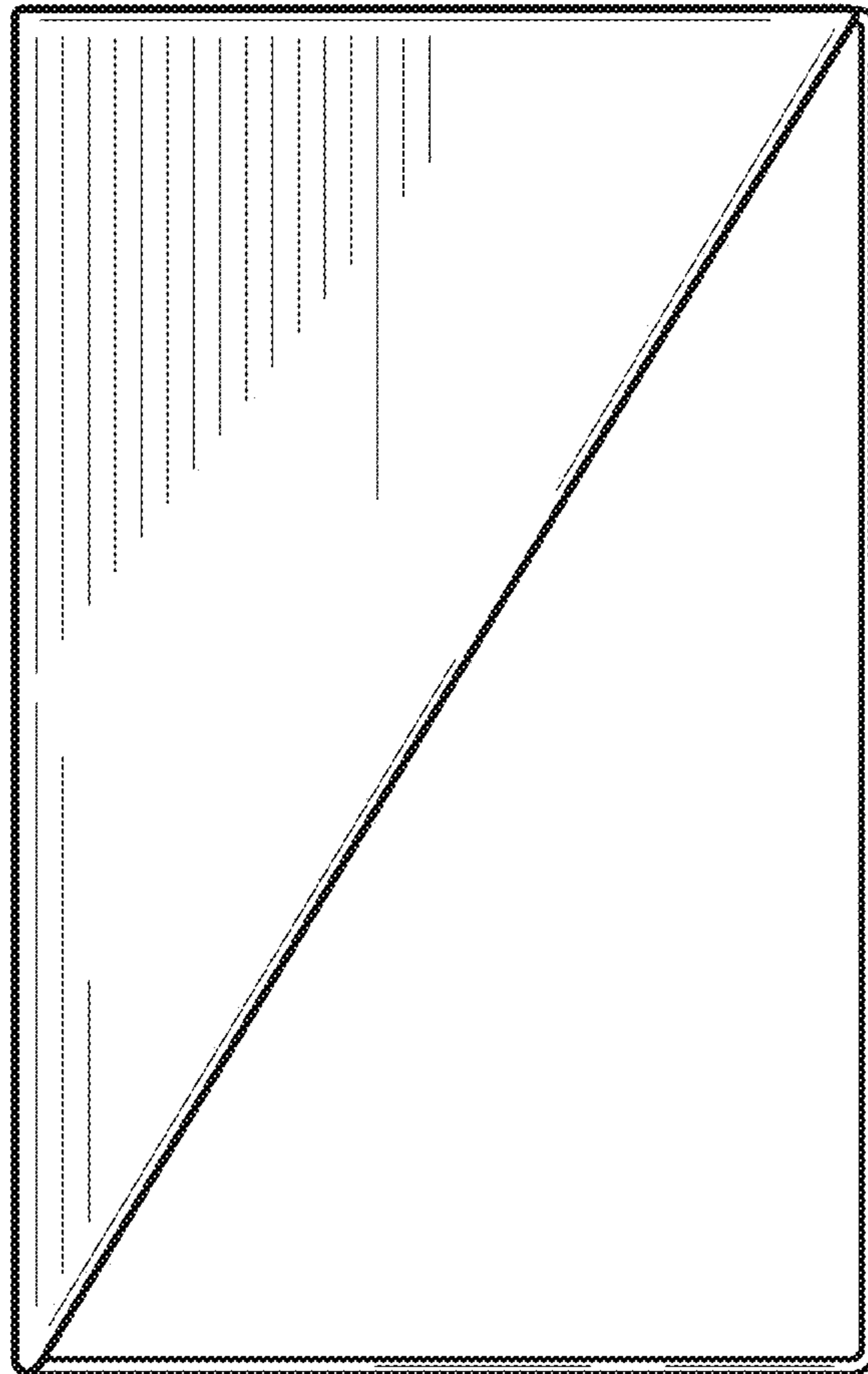

FIG. 3

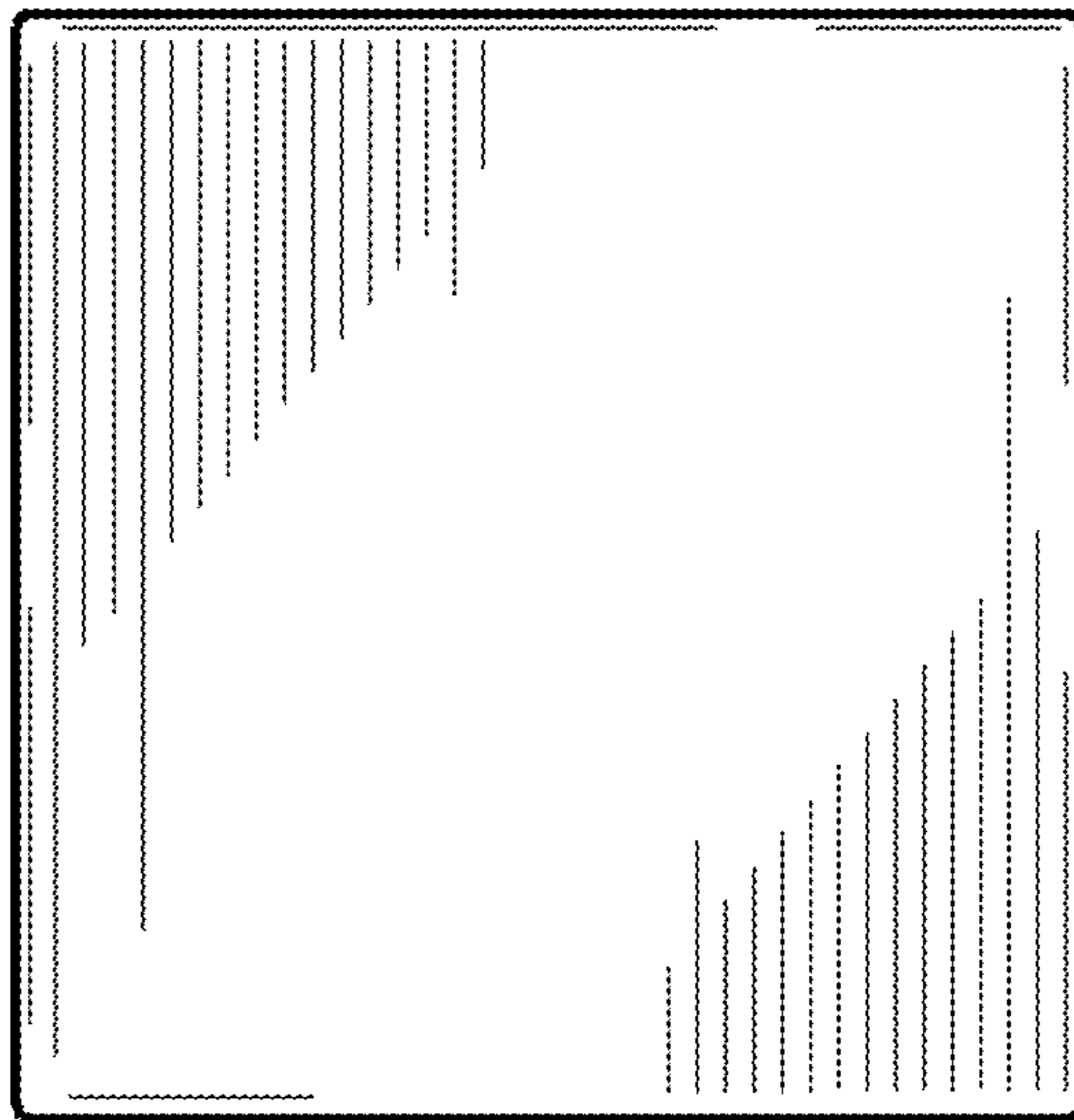

FIG. 4

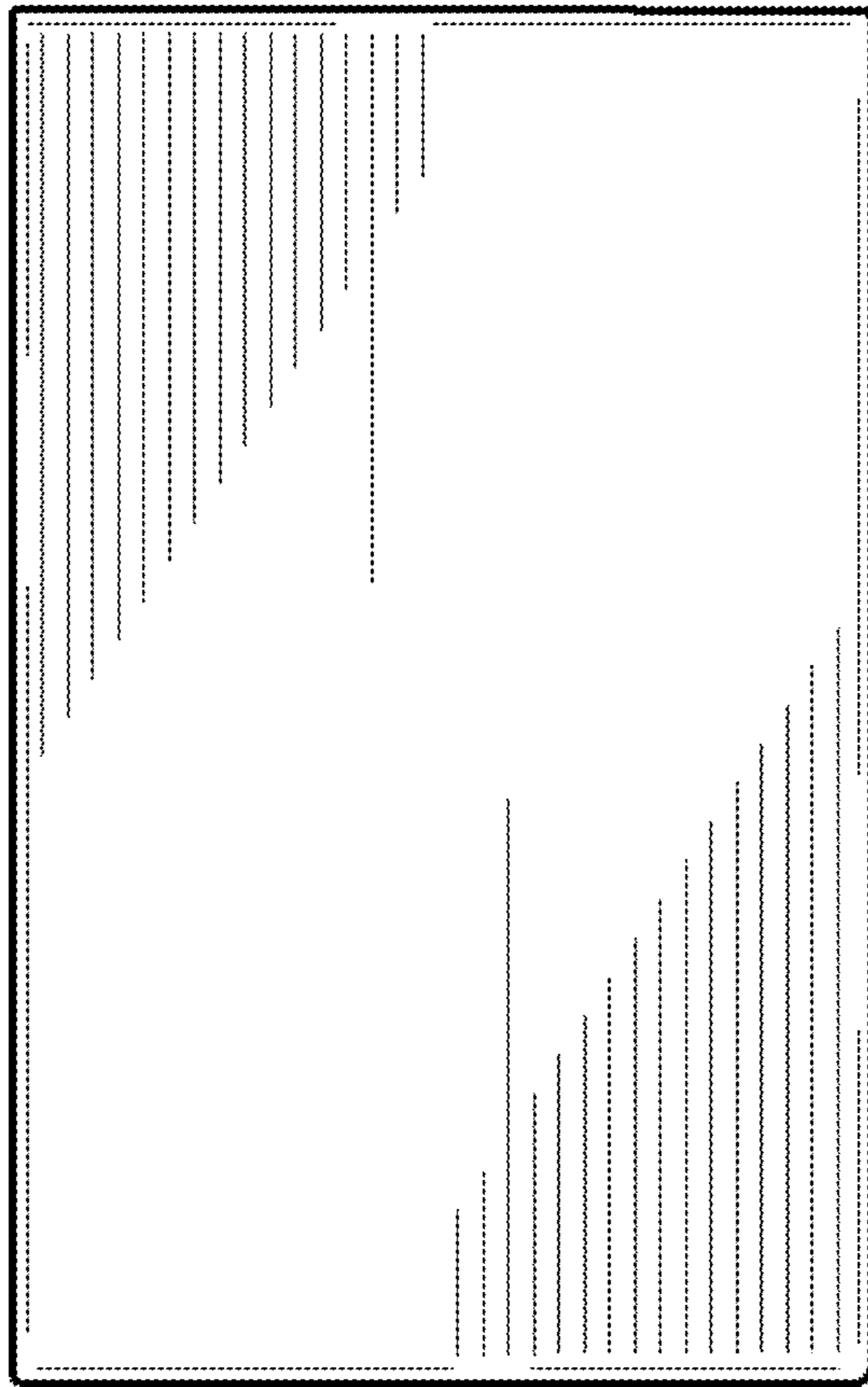

FIG. 5

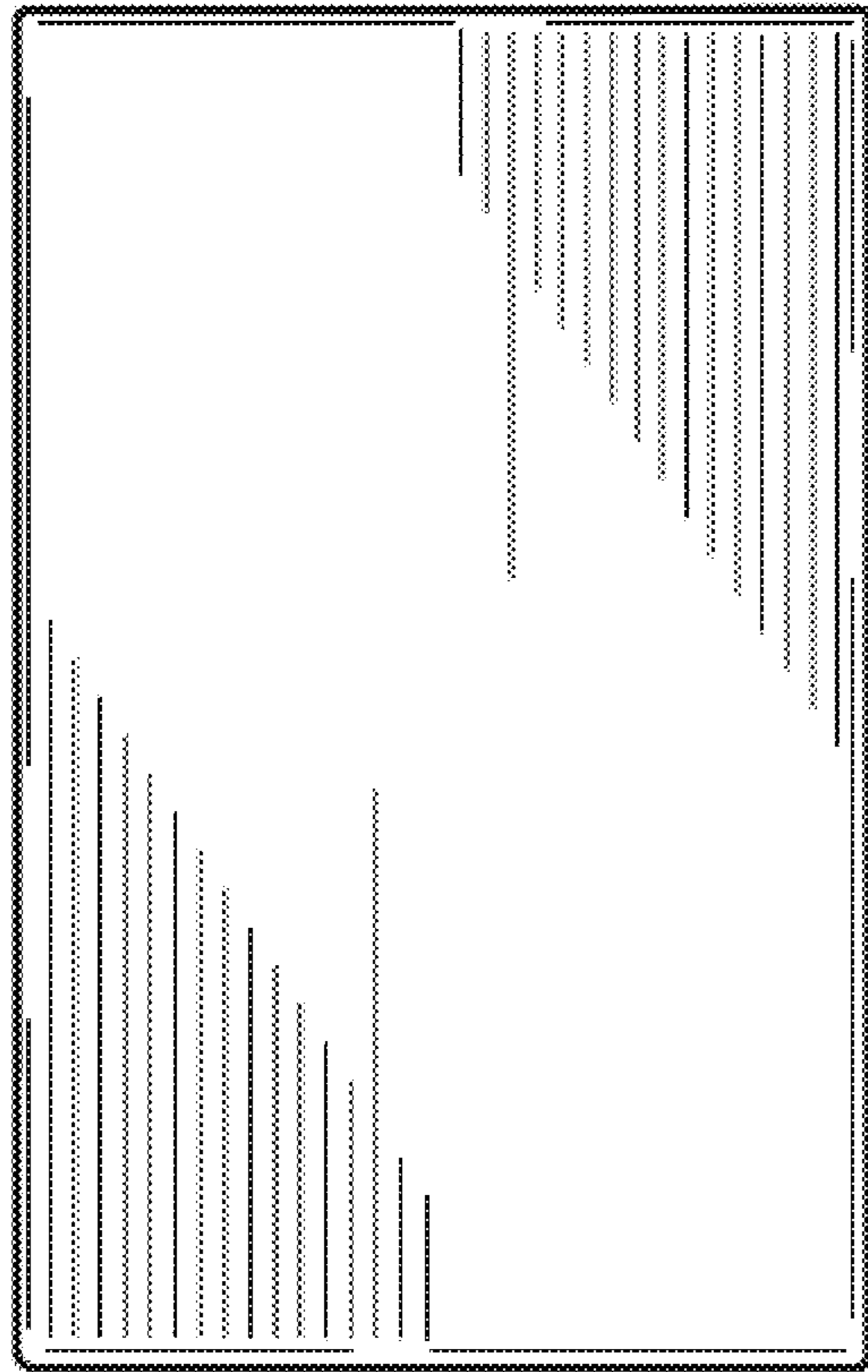

FIG. 6

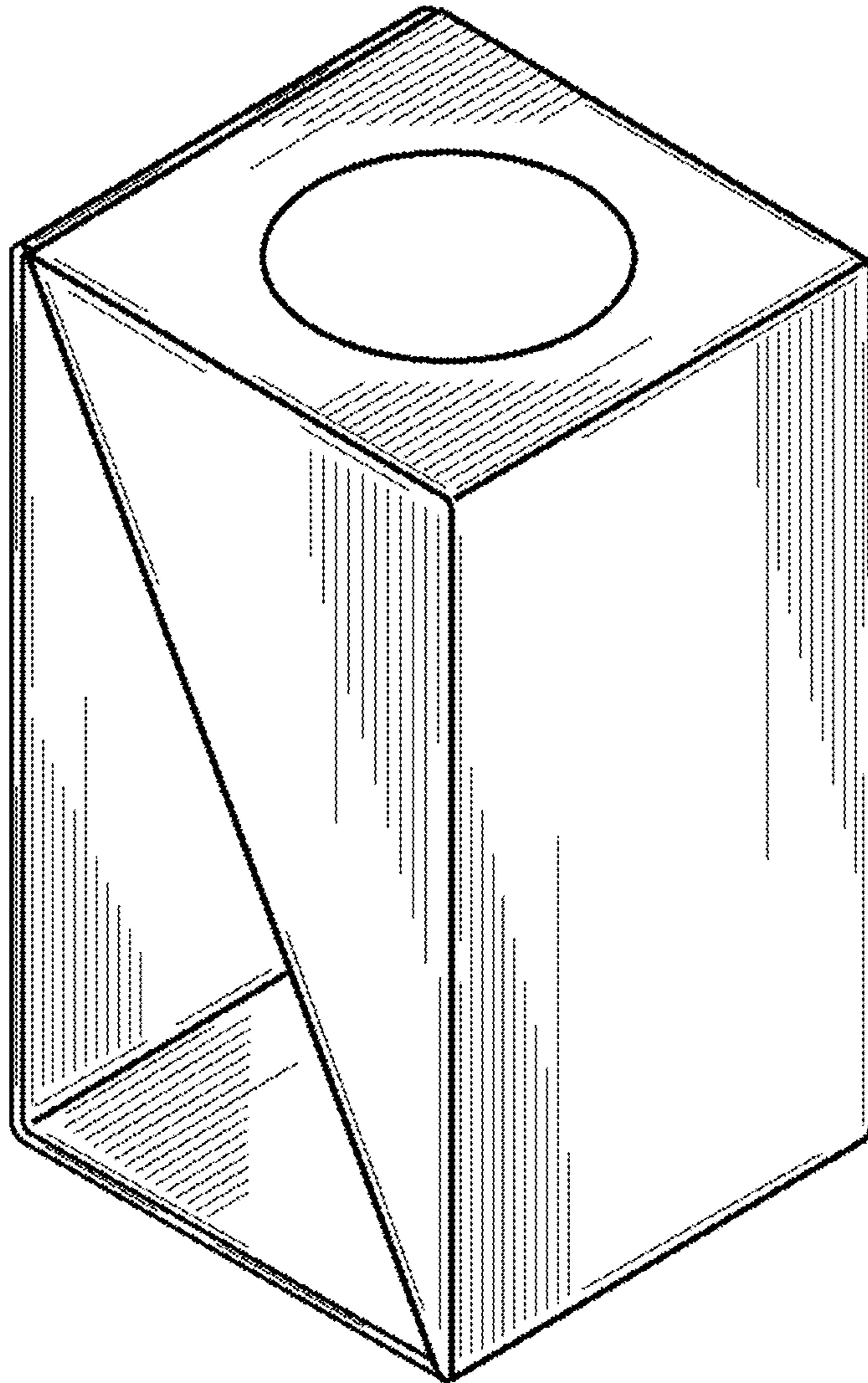

FIG. 7

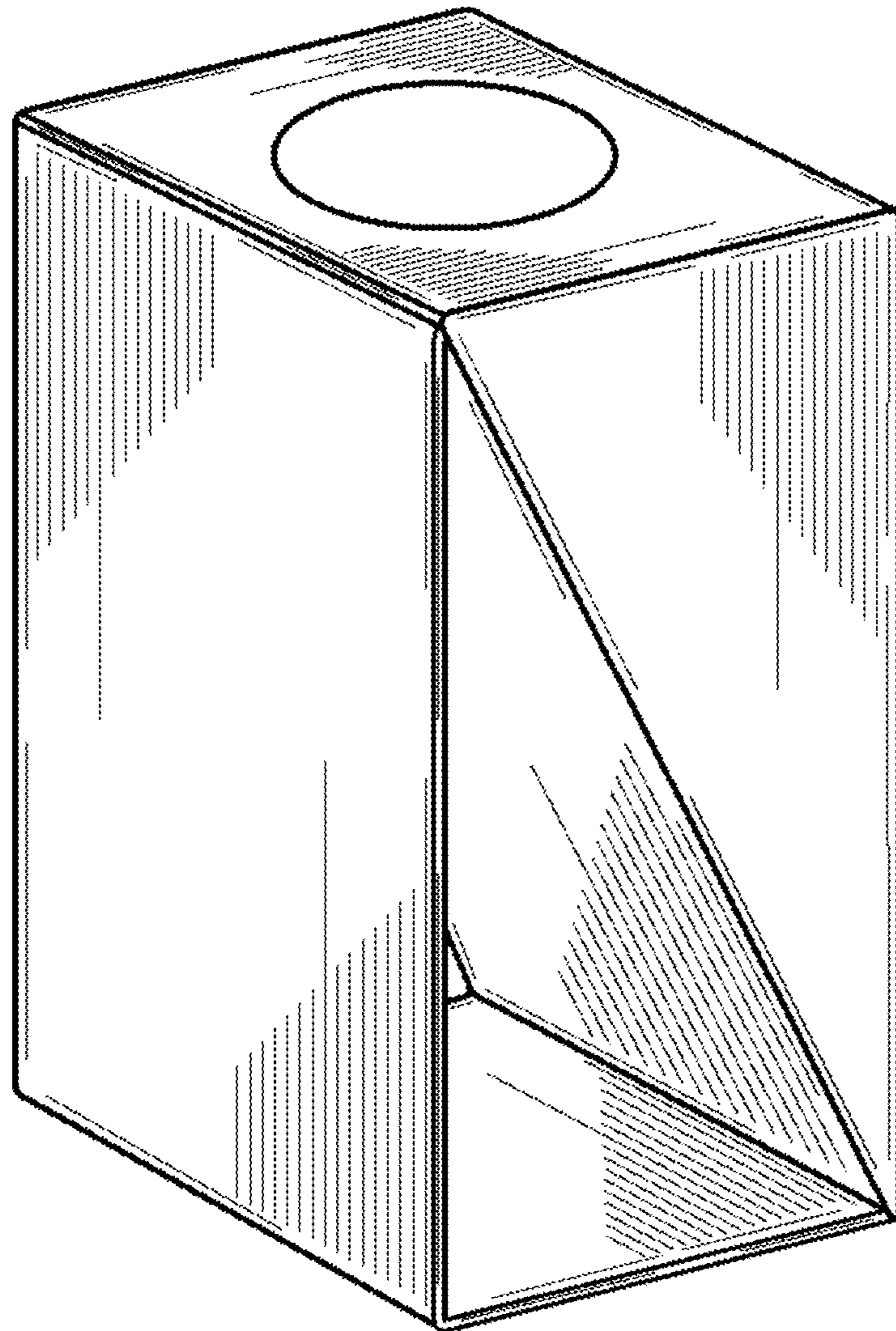

FIG. 8

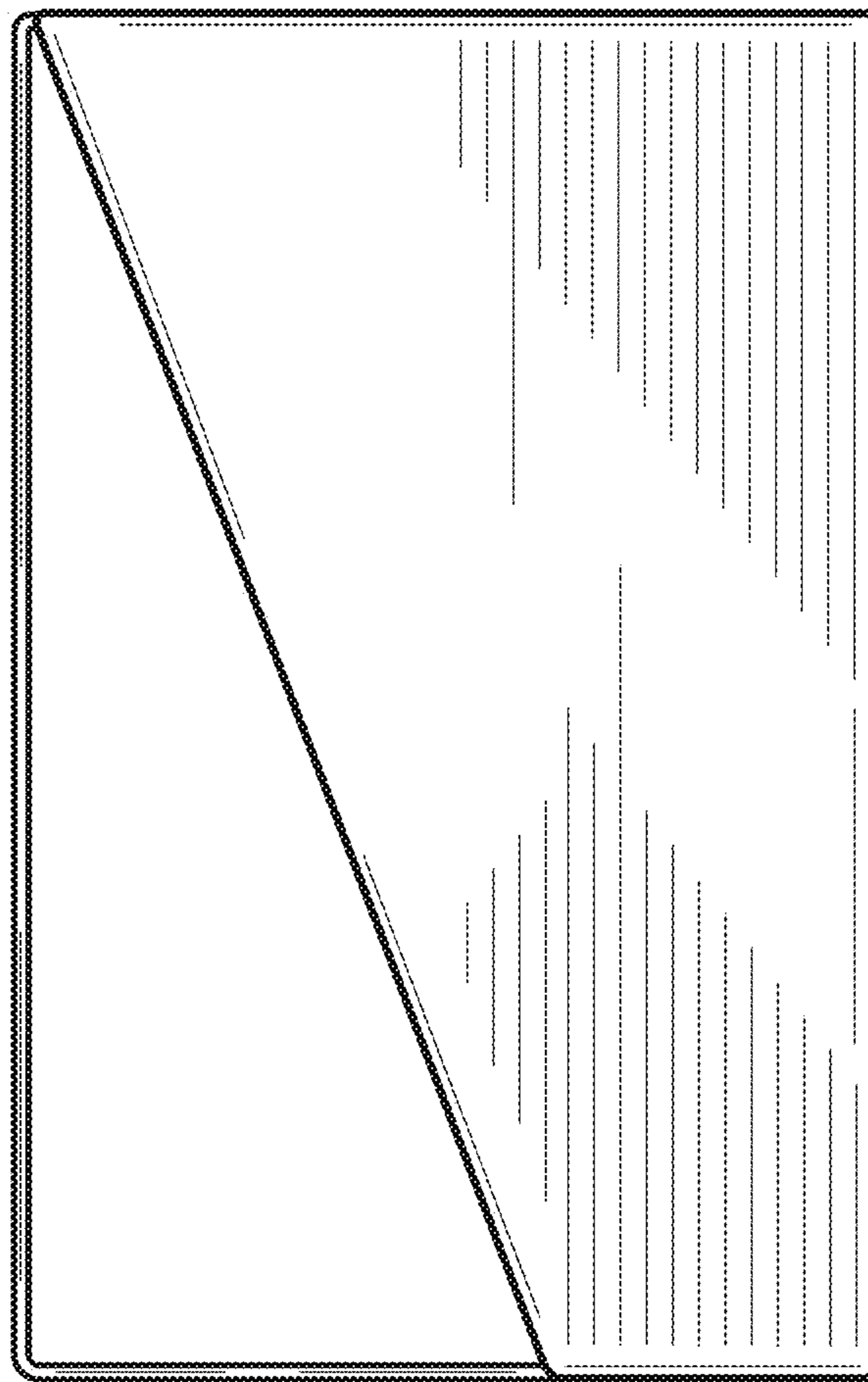

FIG. 9

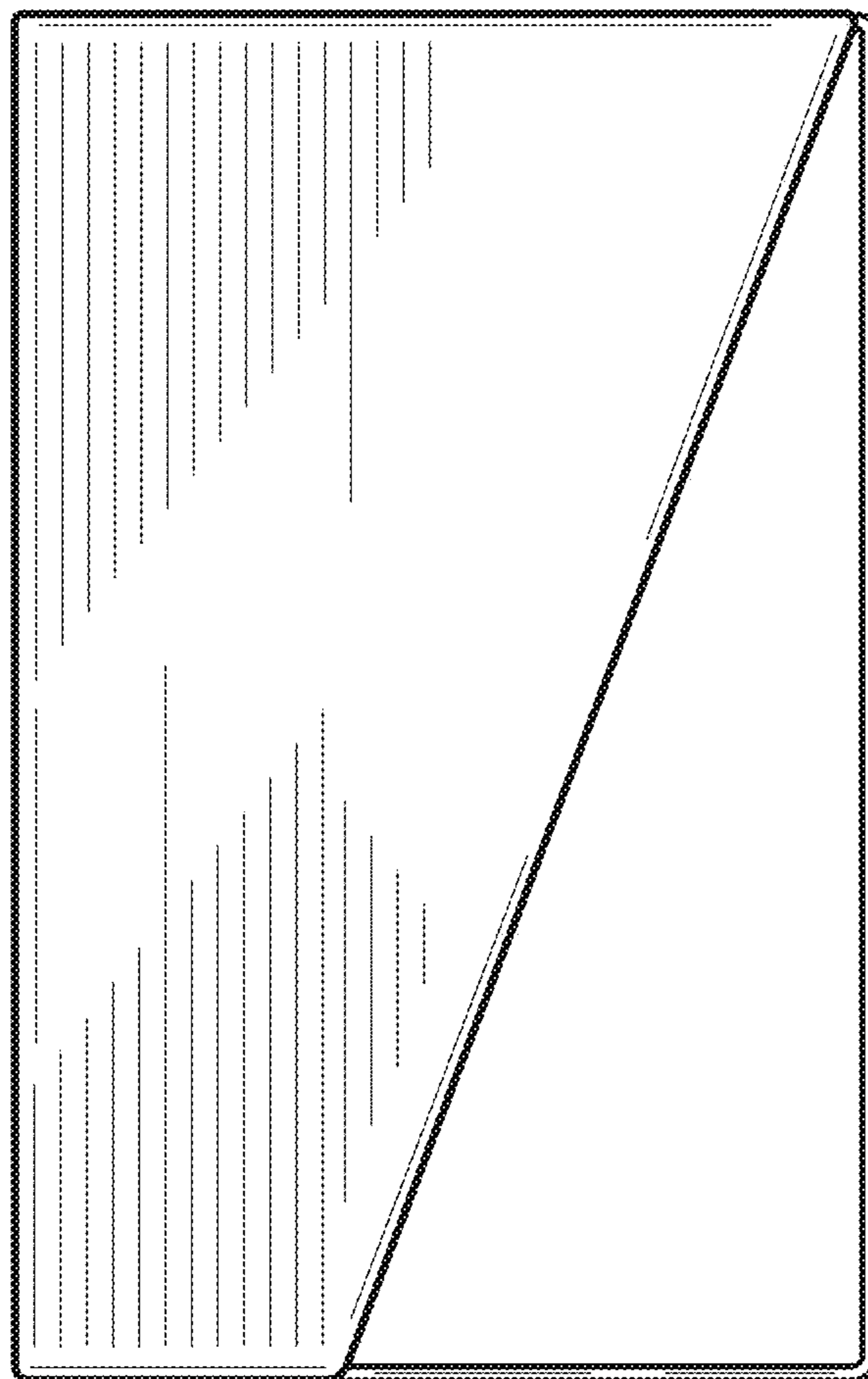

FIG. 10

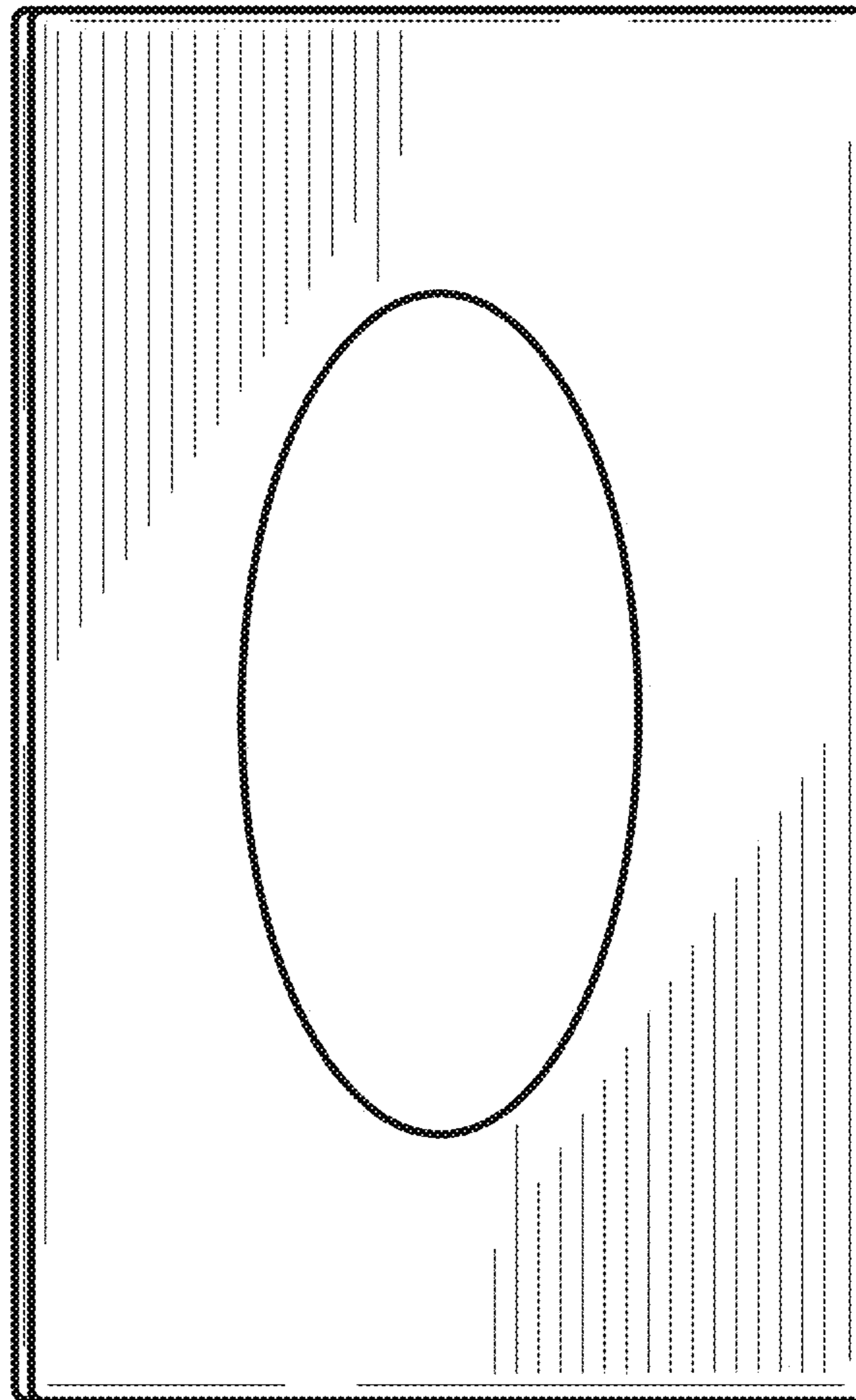

FIG. 11

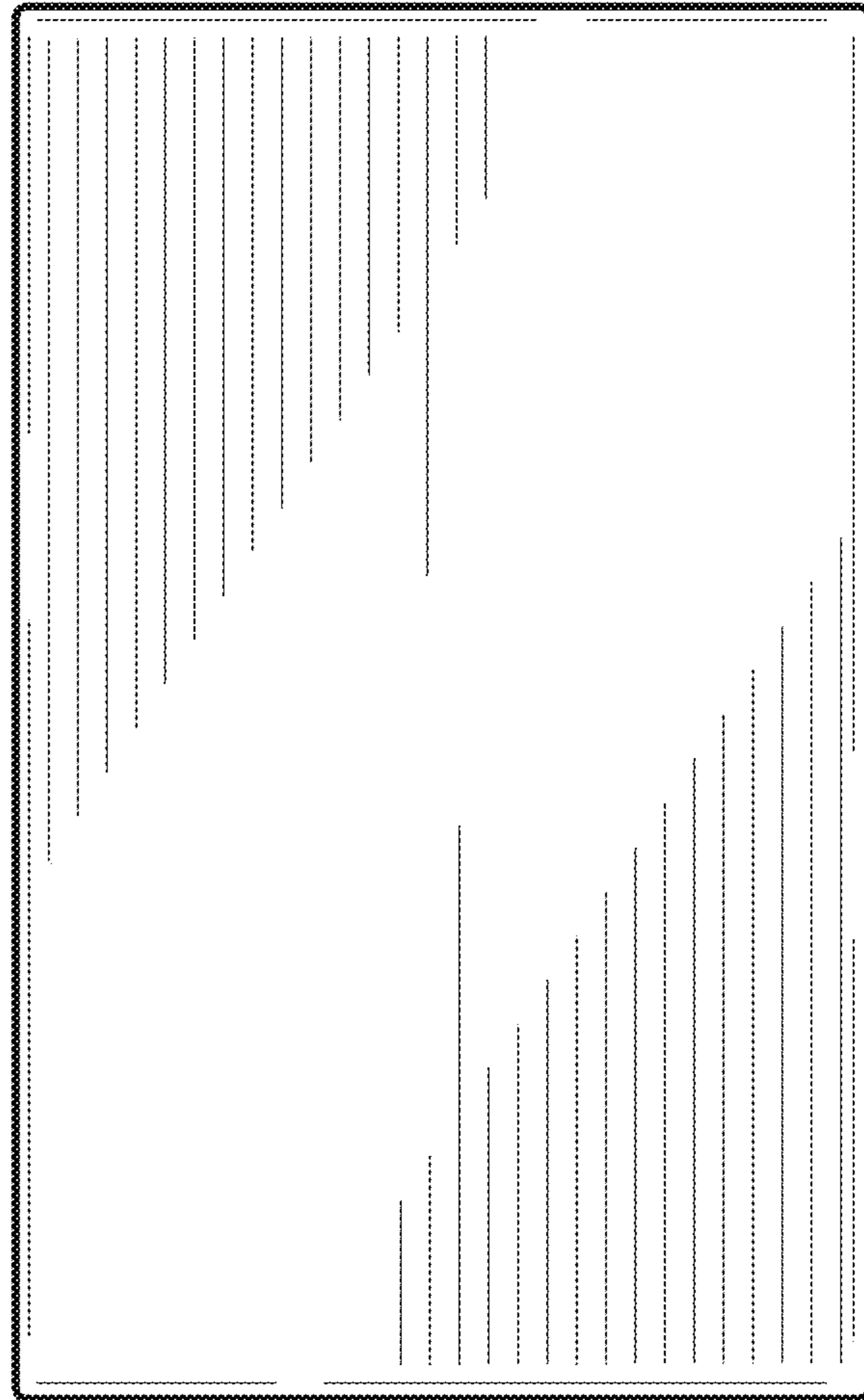

FIG. 12

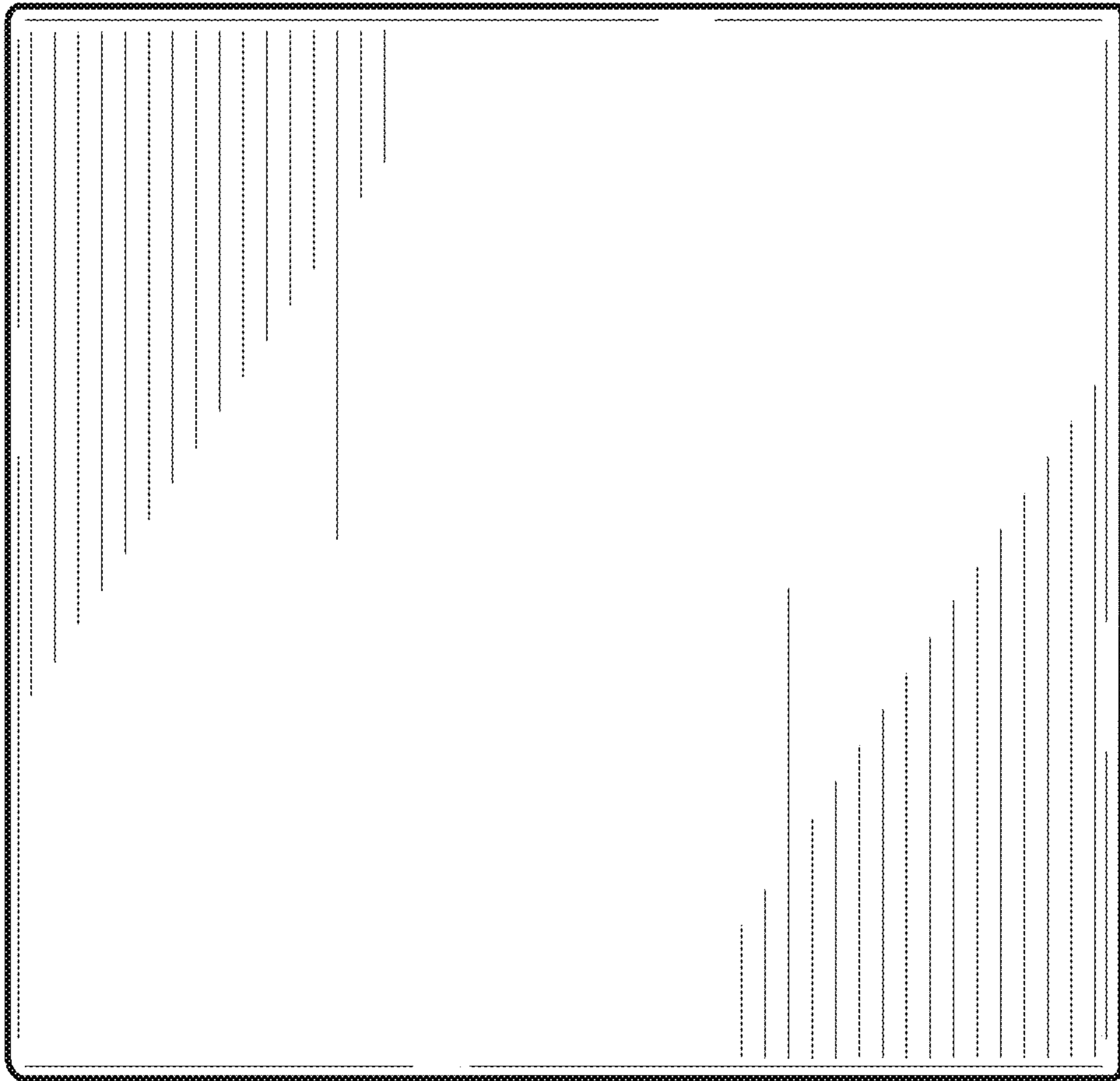

FIG. 13

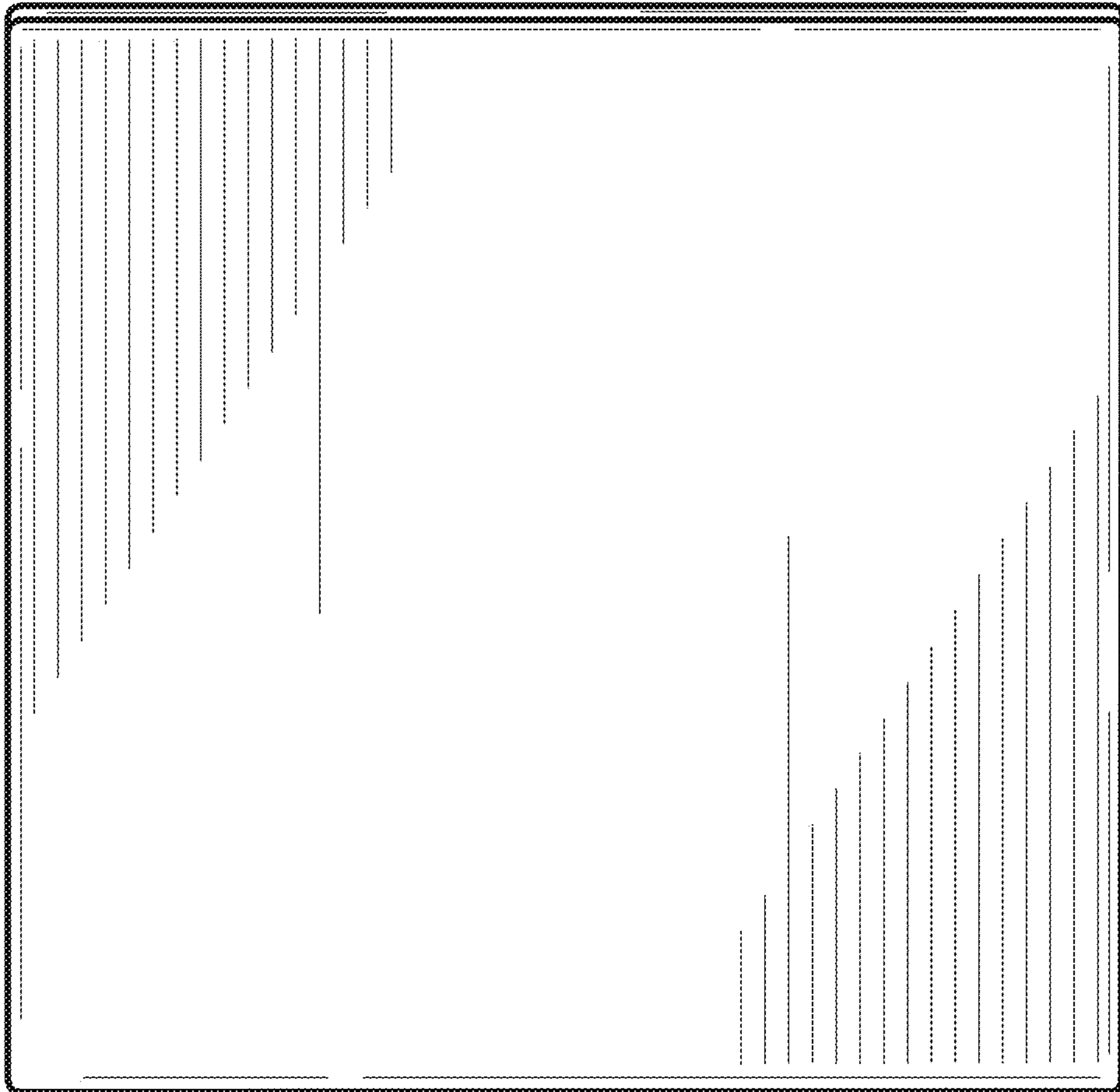

FIG. 14

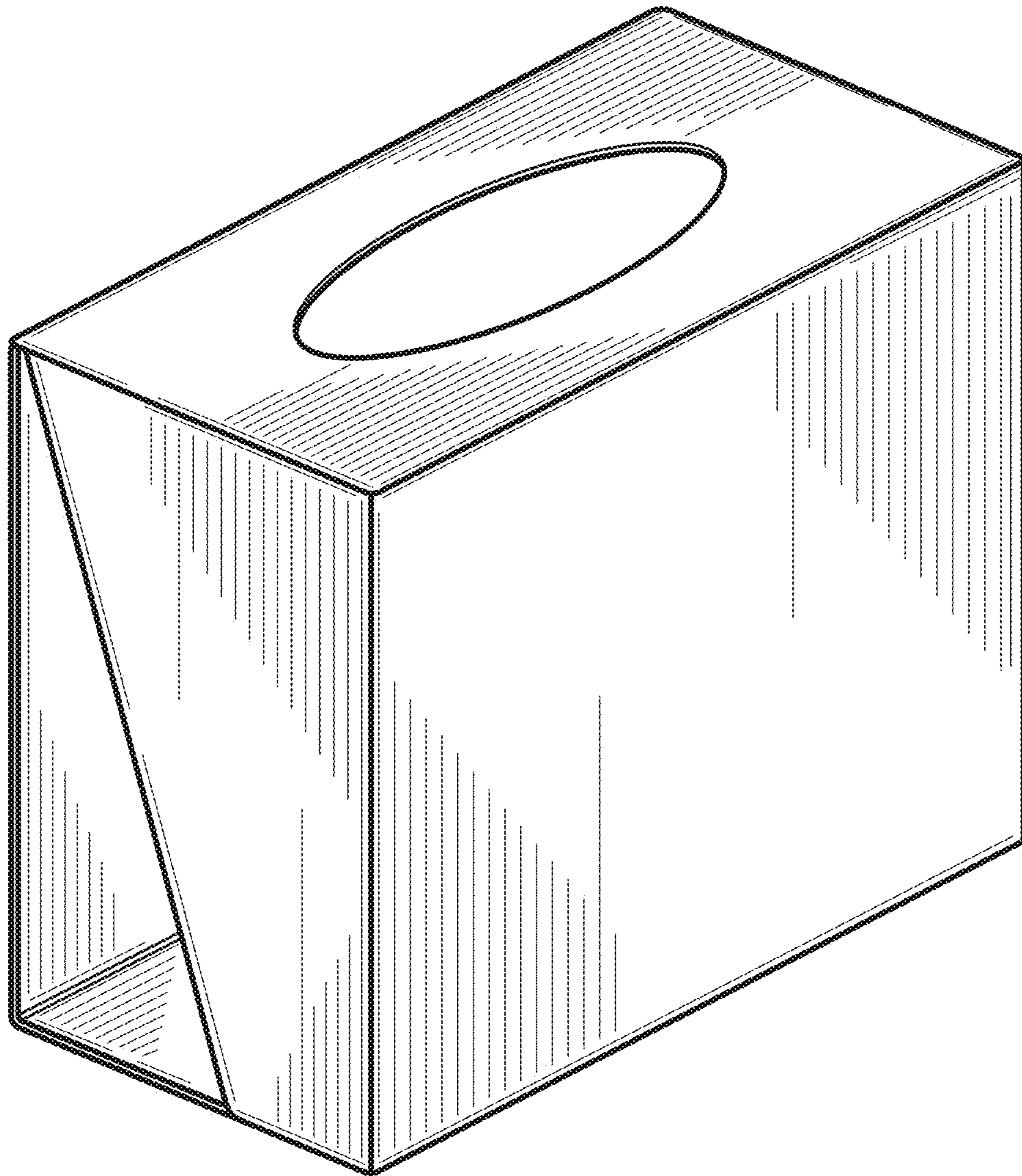

FIG. 15

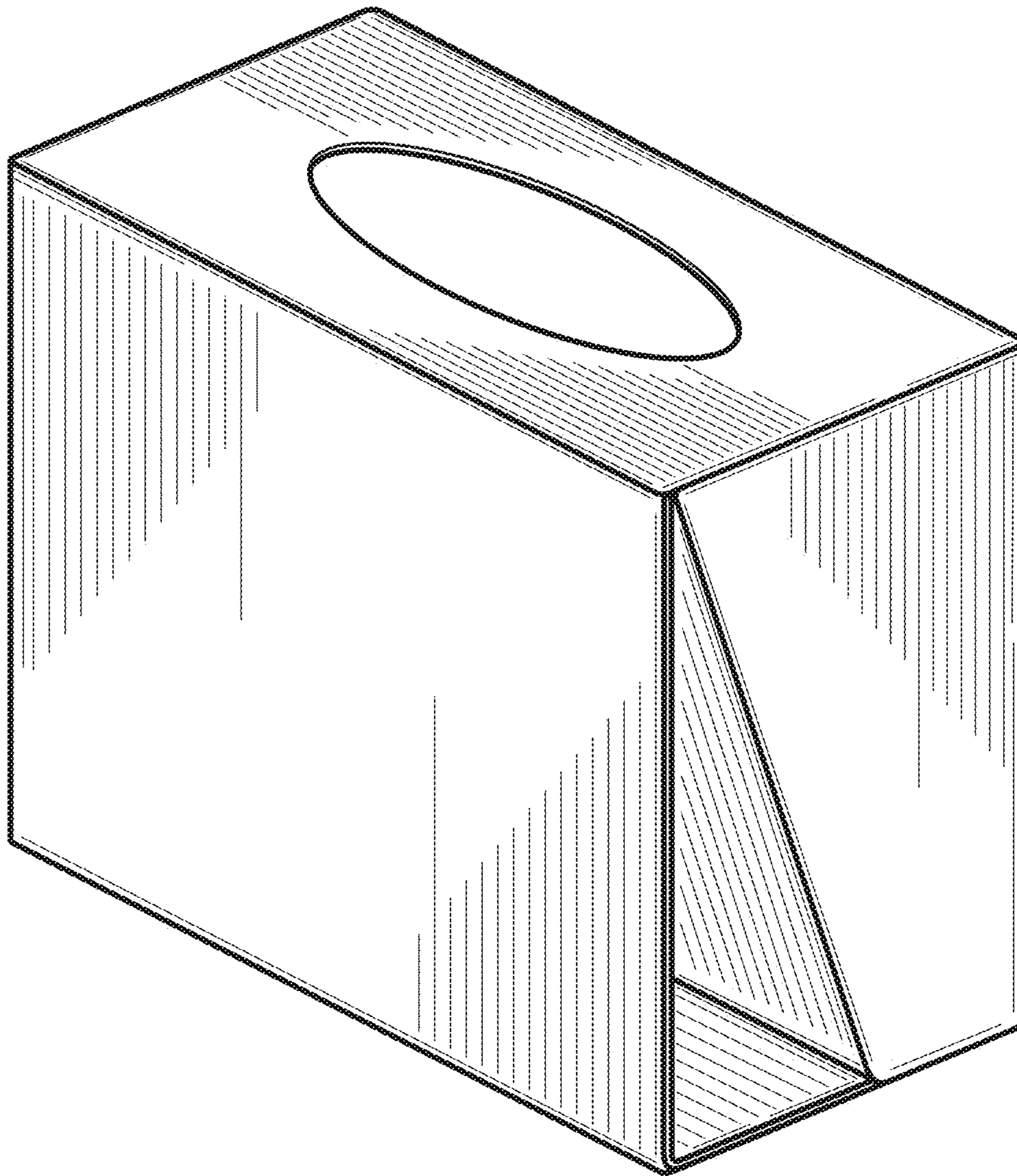

FIG. 16