



US00D876953S

(12) **United States Design Patent** (10) **Patent No.:** **US D876,953 S**
Robinson (45) **Date of Patent:** **** Mar. 3, 2020**

(54) **ROLLER SAVER CONTAINER**
(71) Applicant: **Christopher A. Robinson**, Seattle, WA (US)
(72) Inventor: **Christopher A. Robinson**, Seattle, WA (US)

D633,800 S * 3/2011 Haywood D9/553
D640,935 S * 7/2011 Davies D9/453
D641,591 S * 7/2011 Tsukida D7/608
D651,910 S * 1/2012 Boyer D9/432
D803,008 S * 11/2017 Lipsius D7/615
D808,809 S * 1/2018 Krafft D9/504

* cited by examiner

(**) Term: **15 Years**

Primary Examiner — Karen S Acker

Assistant Examiner — Jasmine Mlinarick

(21) Appl. No.: **29/620,961**

(74) *Attorney, Agent, or Firm* — Paul R. Martin

(22) Filed: **Sep. 11, 2017**

(51) **LOC (12) Cl.** **09-03**

(57) **CLAIM**

(52) **U.S. Cl.**
USPC **D9/503**

The ornamental design for a roller saver container, as shown and described.

(58) **Field of Classification Search**
USPC D7/601, 602, 608, 612; D9/414, 415, D9/418, 430, 431, 432, 433, 451, 454, D9/503, 537, 545, 549, 550, 600, 679, D9/763-783
CPC B65D 1/00; B65D 1/0223; B65D 1/12; B65D 1/14; B65D 1/16; B65D 1/165; B65D 5/38; B65D 5/002
See application file for complete search history.

DESCRIPTION

FIG. 1 is a perspective view of the roller saver container of my new design showing the covering cap thereof separated from the container body.

FIG. 2 is another perspective view of the roller saver container of my new design showing the covering cap secured in place at the top.

FIG. 3 is a front elevational view thereof.

FIG. 4 is a back elevational view thereof.

FIG. 5 is a left side elevational view thereof.

FIG. 6 is a right side elevational view thereof.

FIG. 7 is a bottom plan view thereof; and,

FIG. 8 is a top plan view thereof.

The even-length broken line defines the bounds of the claim and forms no part of the claimed design.

(56) **References Cited**

U.S. PATENT DOCUMENTS

D274,209 S * 6/1984 Kikuchi D7/608
D492,600 S * 7/2004 Moore D9/503
D515,425 S * 2/2006 King D9/504
D537,721 S * 3/2007 Kertels D9/449
D554,508 S * 11/2007 YunFu D9/520
D572,136 S * 7/2008 Boni D9/503
D586,666 S * 2/2009 Lucido D9/772

1 Claim, 7 Drawing Sheets

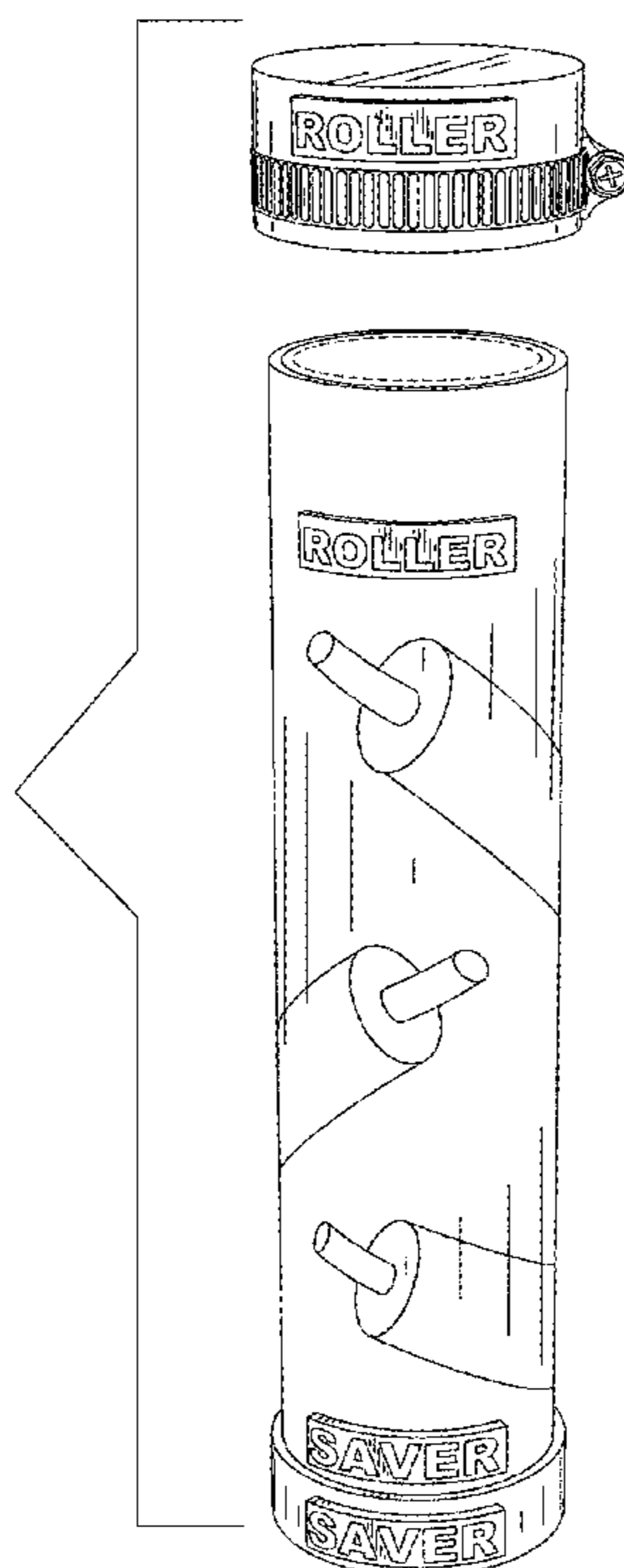

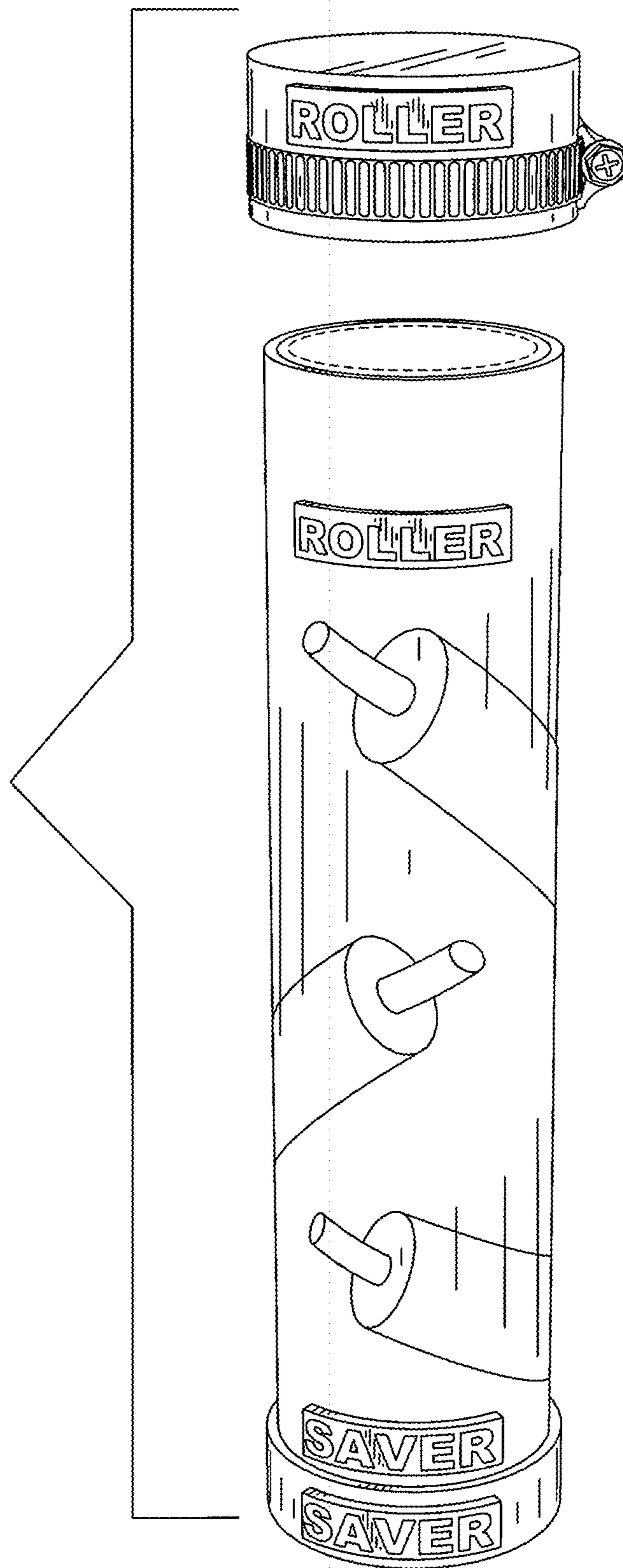

FIG. 1

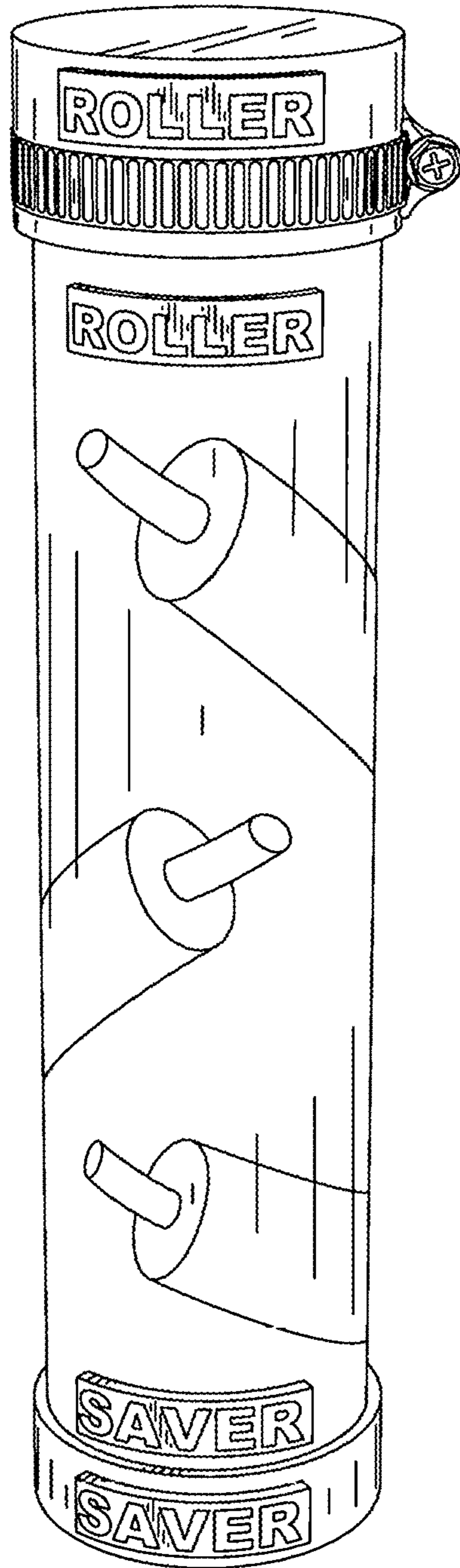

FIG. 2

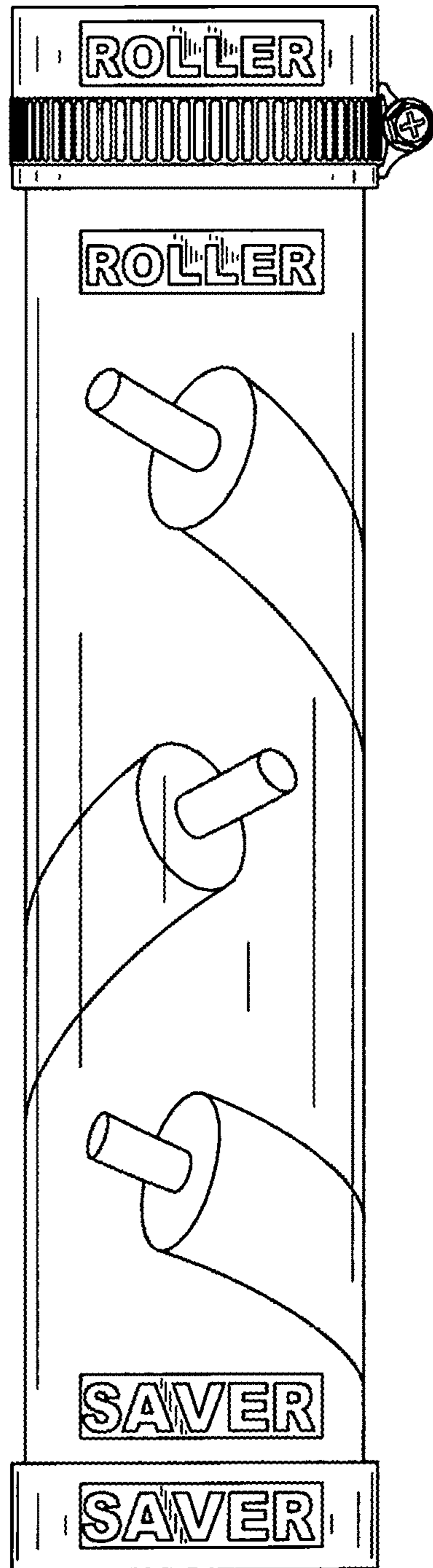

FIG. 3

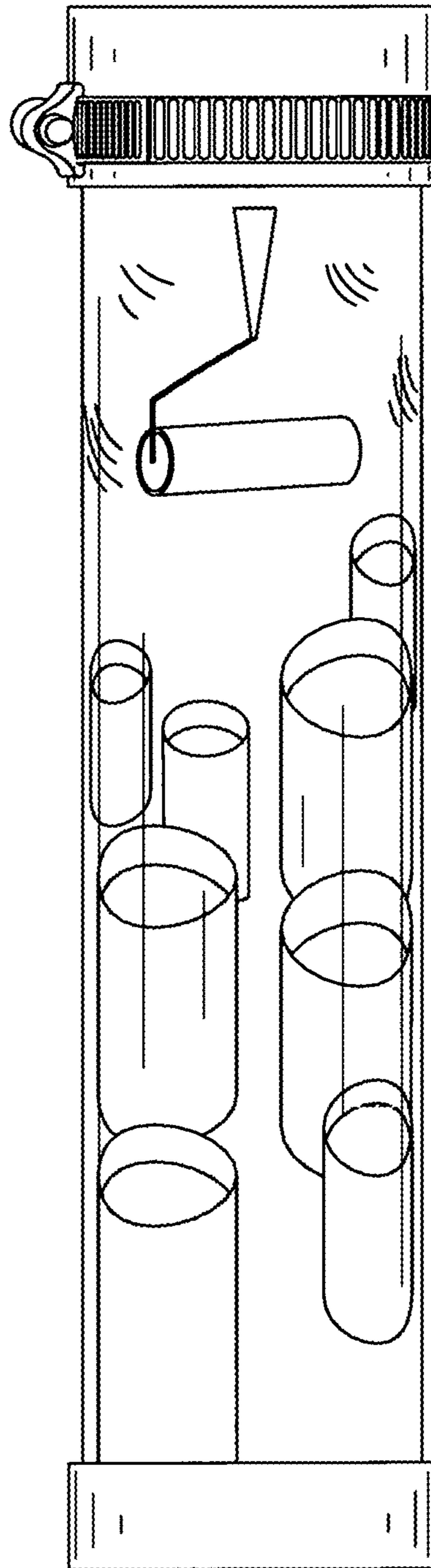
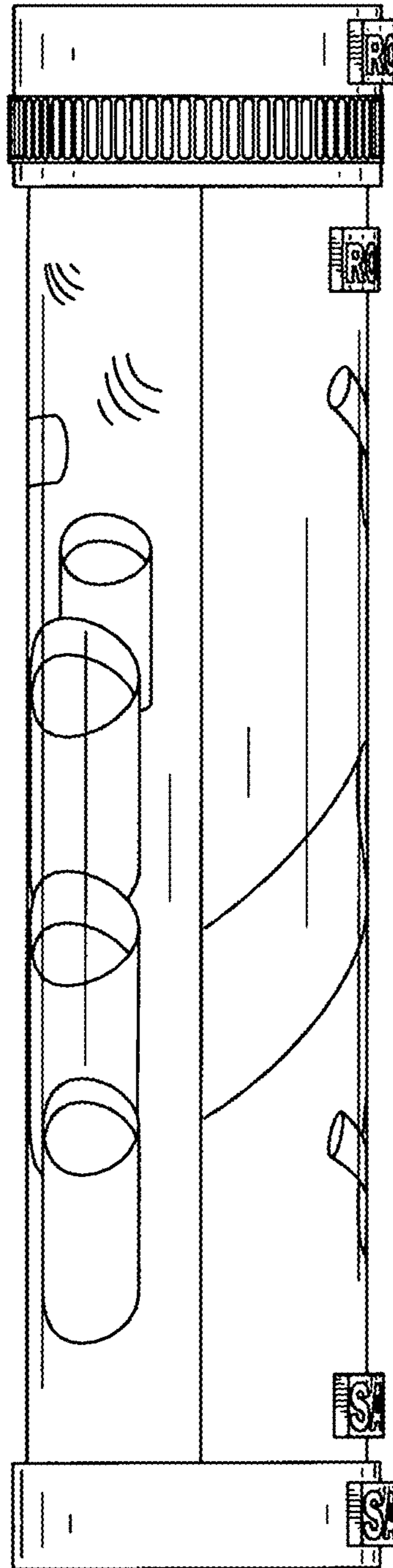

FIG. 4

FIG. 5



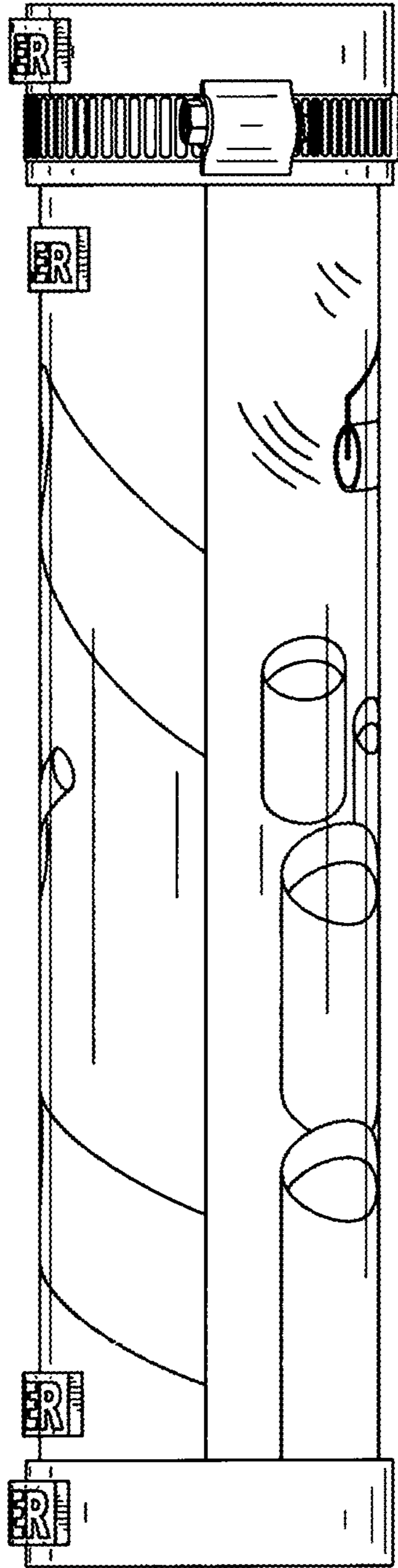

FIG. 6

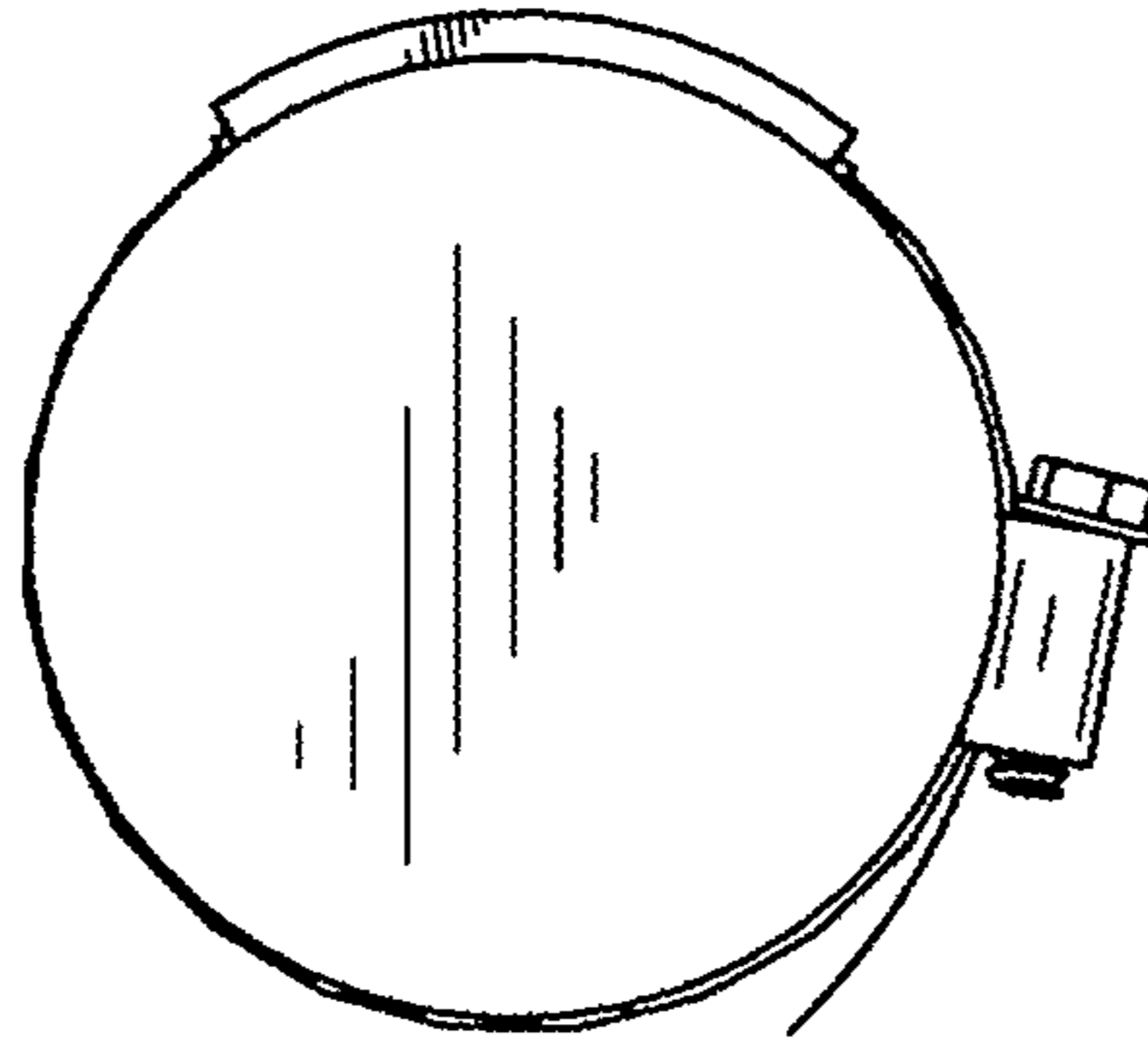

FIG. 7

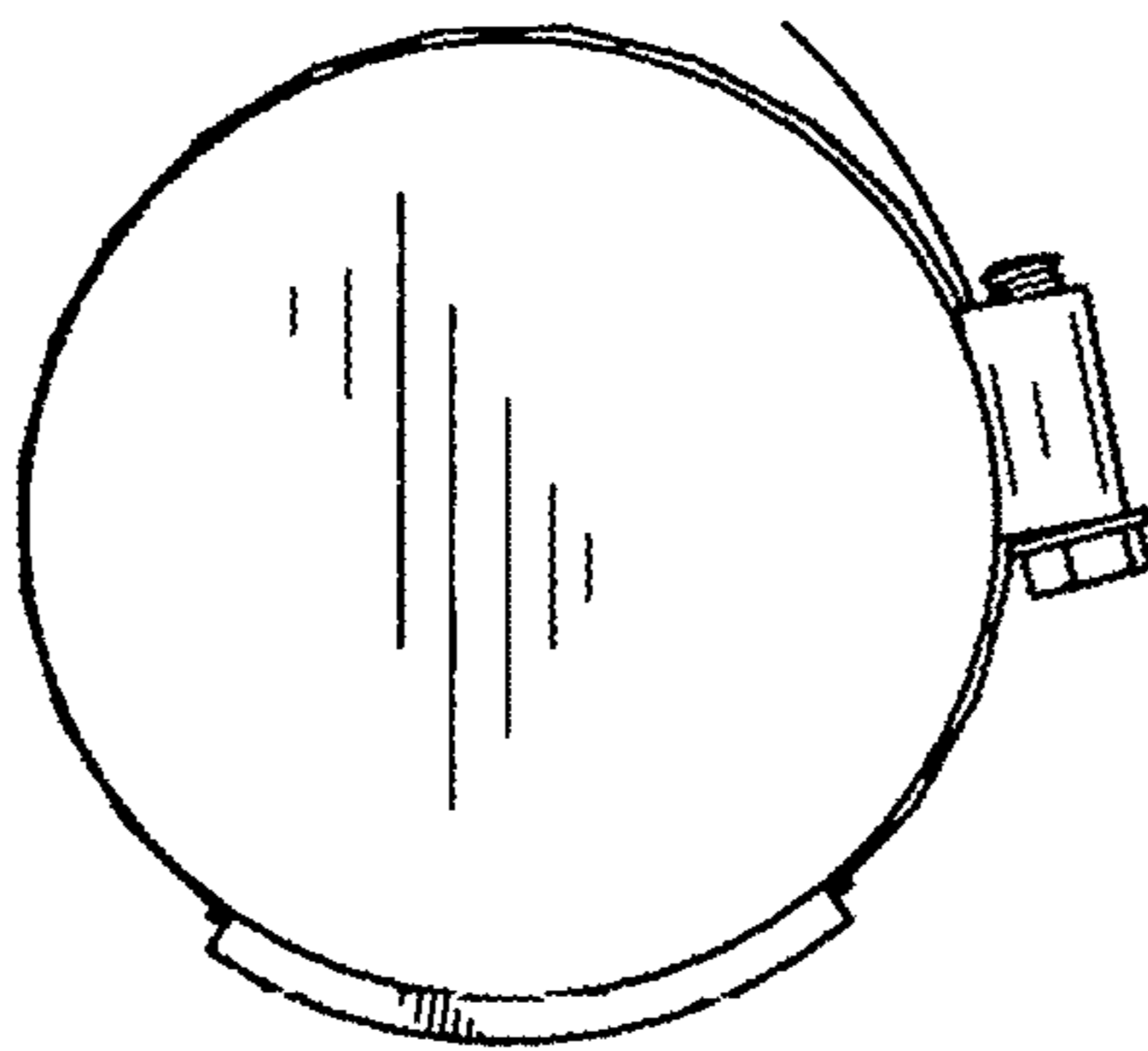

FIG. 8