

US00D876835S

(12) **United States Design Patent**
Libman et al.

(10) **Patent No.:** **US D876,835 S**
(45) **Date of Patent:** **** Mar. 3, 2020**

(54) **CADDY**

(71) Applicant: **The Libman Company**, Arcola, IL (US)

(72) Inventors: **Andrew D. Libman**, Champaign, IL (US); **Aaron Libman**, Champaign, IL (US); **Desi Csoka**, Cary, IL (US); **Jon Franklin**, St. Joseph, IL (US); **Brian Sowinski**, Monticello, IL (US); **Fernando De Jesus Santos**, Maceira Lra (PT)

(73) Assignee: **The Libman Company**, Arcola, IL (US)

(**) Term: **15 Years**

(21) Appl. No.: **29/671,988**

(22) Filed: **Nov. 30, 2018**

(51) **LOC (12) Cl.** **03-01**

(52) **U.S. Cl.**
USPC **D3/310**

(58) **Field of Classification Search**
USPC D3/303–315, 318–319, 328; D7/600.1, D7/601–602, 701
CPC ... B65D 1/00; B65D 1/34; B65D 1/36; B65D 85/00
See application file for complete search history.

(56) **References Cited**

U.S. PATENT DOCUMENTS

D364,039 S *	11/1995	Kruger	D3/315
D381,562 S *	7/1997	Westcott	D3/309
5,803,586 A	9/1998	Velez et al.		
D420,221 S *	2/2000	Williams	D3/315
6,039,205 A	3/2000	Flink		
6,460,697 B1	10/2002	Stevens		
D522,751 S	6/2006	Irwin et al.		

7,117,991 B2	10/2006	Waring		
D537,251 S *	2/2007	Musgrove	D3/201
D541,531 S	5/2007	Leao		
D546,063 S	7/2007	Snyder		
7,290,651 B2	11/2007	Irwin et al.		
D561,473 S *	2/2008	Phillips	D3/304
D575,061 S *	8/2008	Titas	D3/304
7,624,886 B2	12/2009	Huang		
D614,404 S	4/2010	Brunner		
D624,795 S	10/2010	Koeleman		
D649,786 S *	12/2011	Lipfert	D3/308
D653,603 S	2/2012	Stroud et al.		
D655,207 S	3/2012	D'Agostino		

(Continued)

OTHER PUBLICATIONS

“Rough & Rugged Caddy in Taupe”, publication date unknown, but prior to the filing date of the present application, retrieved from <<http://www.homedepot.com/p/United-Solutions-Rough-and-Rugged-Caddy-in-Taupe-CD8012/206263604>> on Jan. 29, 2018.

(Continued)

Primary Examiner — Kelley A Donnelly

(74) *Attorney, Agent, or Firm* — Banner & Witcoff, Ltd.

(57) **CLAIM**

The ornamental design for a caddy, as shown and described.

DESCRIPTION

FIG. 1 is a top, front, right perspective view of a caddy showing our new design;
FIG. 2 is a front view thereof;
FIG. 3 is a rear view thereof;
FIG. 4 is a right side view thereof;
FIG. 5 is a left side view thereof;
FIG. 6 is a top view thereof; and,
FIG. 7 is a bottom, rear, right perspective.
The broken lines depicting the remainder of the caddy show features that form no part of the claimed design.

1 Claim, 7 Drawing Sheets

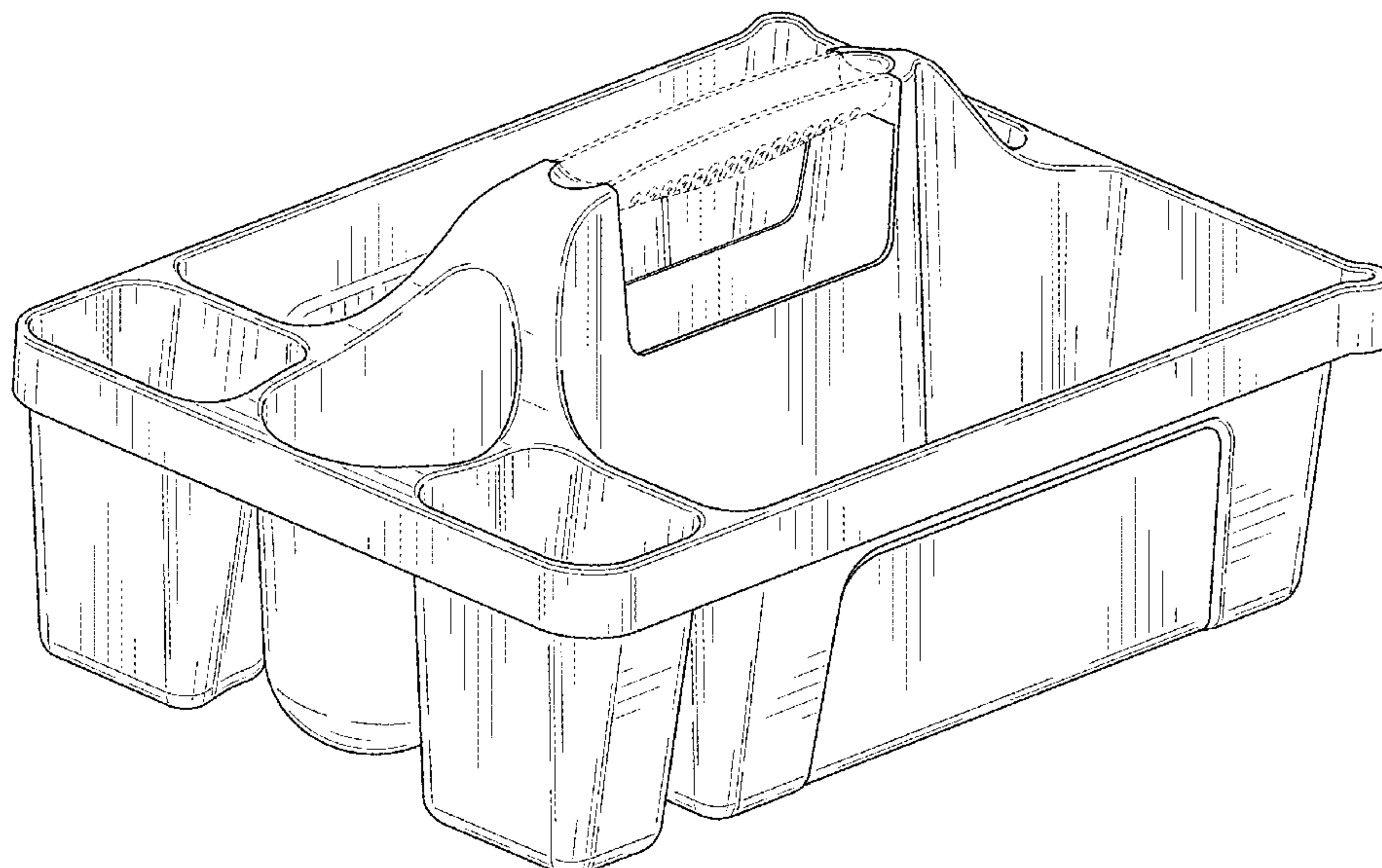

(56)

References Cited

U.S. PATENT DOCUMENTS

D688,589	S	8/2013	Hung et al.	
D690,939	S	10/2013	Lintz et al.	
8,636,169	B2	1/2014	Sampaio	
D704,935	S	5/2014	Lintz et al.	
8,967,379	B2	3/2015	Kinsky et al.	
D725,910	S *	4/2015	Sampaio	B65D 25/2891 D3/315
9,227,316	B2	1/2016	Stevens	
D757,469	S *	5/2016	Jensen	D6/683.1
9,469,436	B1	10/2016	Keup	
D789,690	S *	6/2017	Foley	D3/310
D790,857	S	7/2017	Pabonan	
D793,715	S *	8/2017	Mean	D3/203.1
D795,584	S	8/2017	Walker, Jr. et al.	
D801,075	S *	10/2017	Jack	D6/525
D805,402	S *	12/2017	Gamble	D9/755
D824,674	S *	8/2018	Seiders	D3/310
D838,482	S *	1/2019	Pistauer	D3/304
D843,113	S *	3/2019	Carter	D3/315
2005/0211707	A1	9/2005	Mak et al.	
2006/0027469	A1 *	2/2006	Irwin	A47L 13/51 206/216
2008/0230416	A1	9/2008	Brouard	
2010/0018937	A1	1/2010	Goto et al.	
2010/0133132	A1	6/2010	Allan	

OTHER PUBLICATIONS

“Deluxe Carry Caddy”, publication date unknown, but prior to the filing date of the present application, retrieved from <<http://www.homedepot.com/p/Rubbermaid-Commercial-Products-Deluxe-Carry-Caddy-FG315488BLA/203006338>> on Jan. 29, 2018.

“Sterilite Divided Ultra Caddy”, publication date unknown, but prior to the filing date of the present application, retrieved from <http://www.homedepo.com/p/Sterilite-Divided-Ultra-Caddy-15888006/206747520?MERCH=REC-_-NavPLPHorizontal1_rr-_-NA-_-206747520-_-N> on Jan. 29, 2018.

“Black Divided Carry Caddy”, publication date unknown, but prior to the filing date of the present application, retrieved from <http://www.homedepo.com/p/Rubbermaid-Commercial-Products-Black-Divided-Carry-Caddy-1880994/205352837?MERCH=REC-_-PIPHorizontal1rr-_-206747520-_-205352837-_-N> on Jan. 29, 2018.

“16 in×11in×5.25 in Polyethylene Janitor Supplies Carrier”, publication date unknown, but prior to the filing date of the present application, retrieved from <<http://www.officesupplyinc.com/janitor-carrier-supplies-plastic-16x11x5-gray-p-6297.html>> on Jan. 29, 2018.

“2649 Maid Caddy for Brute Containers”, publication date unknown, but prior to the filing date of the present application, retrieved from <<https://www.amazon.com/Rubbermaid-Commercial-Caddy-2-Comp-Height/dp/B00Z7ZIJEM>> on Jan. 29, 2018.

“49 Gray Plastic Cleaning Caddy, 19L×13.5W (Maxi Maid Carrier)”, publication date unknown, but prior to the filing date of the present application, retrieved from <<https://www.webstaurantstore.com/continental-49-gray-maxi-maid-carrier-janitor-caddy/27449%20%20%20%20%20%20%20GY.html%20>> on Jan. 29, 2018.

“Lavex Janitorial Plastic Cleaning Caddy, 3 compartment, 16L×11W”, publication date unknown, but prior to the filing date of the present application, retrieved from <<https://www.webstaurantstore.com/lavex-janitorial-plastic-cleaning-caddy-3-compartment-gray-16l-x-11w/27448%20%20%20%20%20%20%20GY.html>> on Jan. 29, 2018.

“Lavex Janitorial Plastic Cleaning Caddy, 4 compartment”, publication date unknown, but prior to the filing date of the present application, retrieved from <<https://www.webstaurantstore.com/lavex-janitorial-plastic-cleaning-caddy-4-compartment-gray-11-5l-x-9w/27446%20%20%20%20%20%20%20GY.html>> on Jan. 29, 2018.

“Lavex Janitorial Plastic Cleaning Caddy, 3 compartment, 15.25L×13.25W”, publication date unknown, but prior to the filing date of the present application, retrieved from <<https://www.webstaurantstore.com/lavex-janitorial-large-cleaning-caddy-3-compartment-gray-15-25l-x-13-25w/27447%20%20%20%20%20%20%20GY.html>> on Jan. 29, 2018.

“Gray Plastic Carry Caddy”, publication date unknown, but prior to the filing date of the present application, retrieved from <[https://www.grainger.com/product/TOUGH-GUY-Gray-Plastic-Carry-Caddy-2NXW4?s_pp=false&picUrl=//static.grainger.com/rp/s/is/image/Grainger/2NXW4_AS01?\\$smthumb\\$](https://www.grainger.com/product/TOUGH-GUY-Gray-Plastic-Carry-Caddy-2NXW4?s_pp=false&picUrl=//static.grainger.com/rp/s/is/image/Grainger/2NXW4_AS01?$smthumb$)> on Jan. 29, 2018.

“Caddy, Housekeeping Cart, Registry®, 11 in×6.88 in×15.75 in, Gray”, publication date unknown, but prior to the filing date of the present application, retrieved from <<http://www.americanhotel.com/Products/Caddy-Housekeeping-Cart-Registry%C2%AE-11-in-x-688-in-x-1575-in-Gray.aspx?R=45118280>> on Jan. 29, 2018.

“Blue Tote Caddy”, publication date unknown, but prior to the filing date of the present application, retrieved from <<https://www.usplastic.com/catalog/item.aspx?itemid=40711&catid=1098>> on Jan. 29, 2018.

“Utility Carrier”, publication date unknown, but prior to the filing date of the present application, retrieved from <<https://www.usplastic.com/catalog/item.aspx?itemid=36651&catid=635>> on Jan. 29, 2018.

“O-Cedar Commercial MaxiRough® Maid’s Caddy Gray”, publication date unknown, but prior to the filing date of the present application, retrieved from <<https://www.walmart.com/ip/O-CEDAR-MaxiRough-Maid-s-Caddy-Set-of-6/42823415>> on Jan. 29, 2018.

“O’Dell Maid’s Caddy”, publication date unknown, but prior to the filing date of the present application, retrieved from <<https://www.odellcorp.com/products/maids-caddy>> on Jan. 29, 2018.

“Housekeeping Carrier”, publication date unknown, but prior to the filing date of the present application, retrieved from <https://www.nathosp.com/product/ar48/cleaning_supplies> on Jan. 29, 2018.

“GatorMate® Portable Caddy”, publication date unknown, but prior to the filing date of the present application, retrieved from <<https://imagesupplyinc.com/catalog/p/1850/Impact-GatorMate-Portable-Caddy/>> on Jan. 29, 2018.

“Impact Products Maid’s Basket”, publication date unknown, but prior to the filing date of the present application, retrieved from <<https://www.cleanitsupply.com/p-101464/impact-products-maids-basket-1-each-imp1803.aspx>> on Jan. 29, 2018.

* cited by examiner

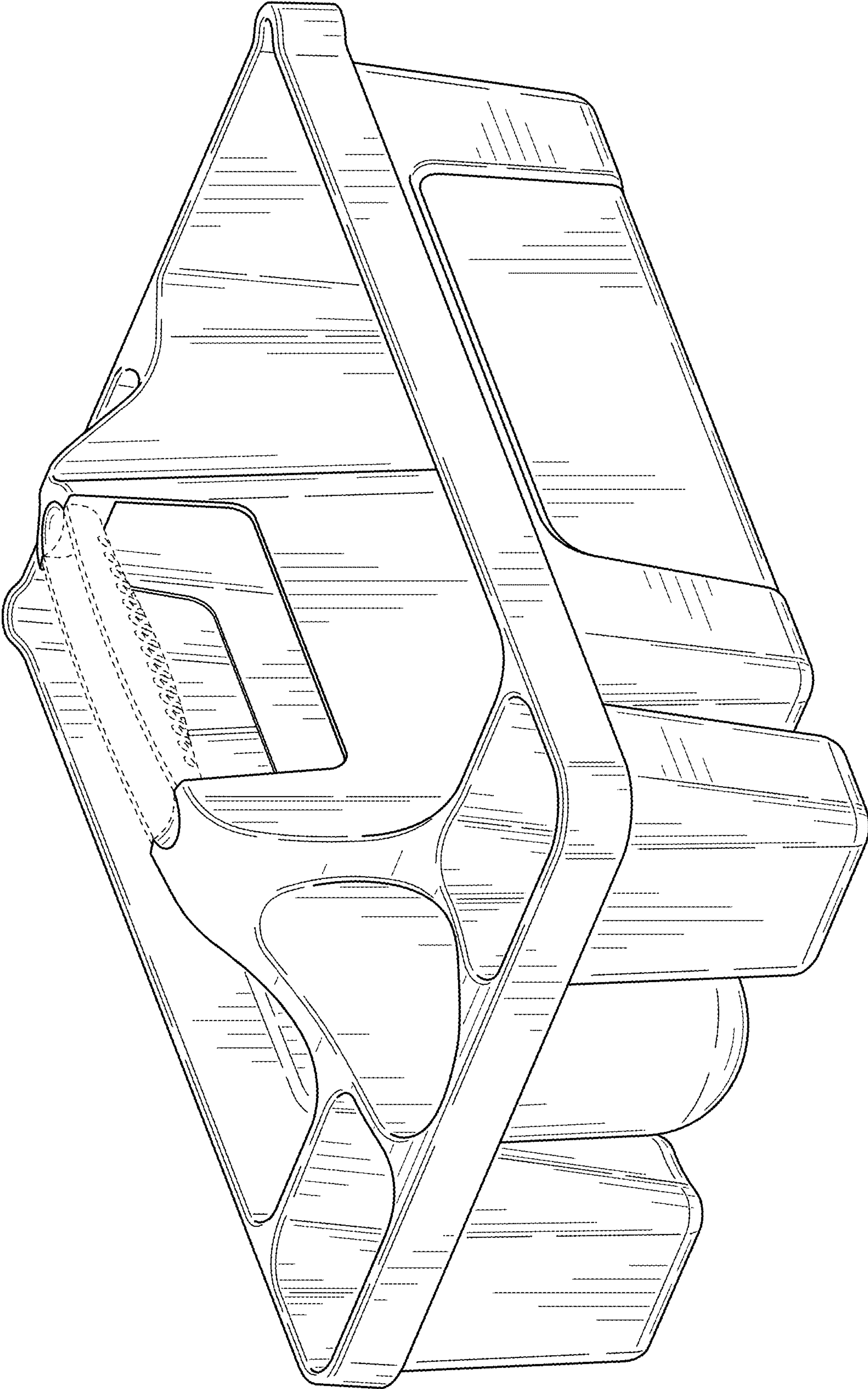

FIG. 1

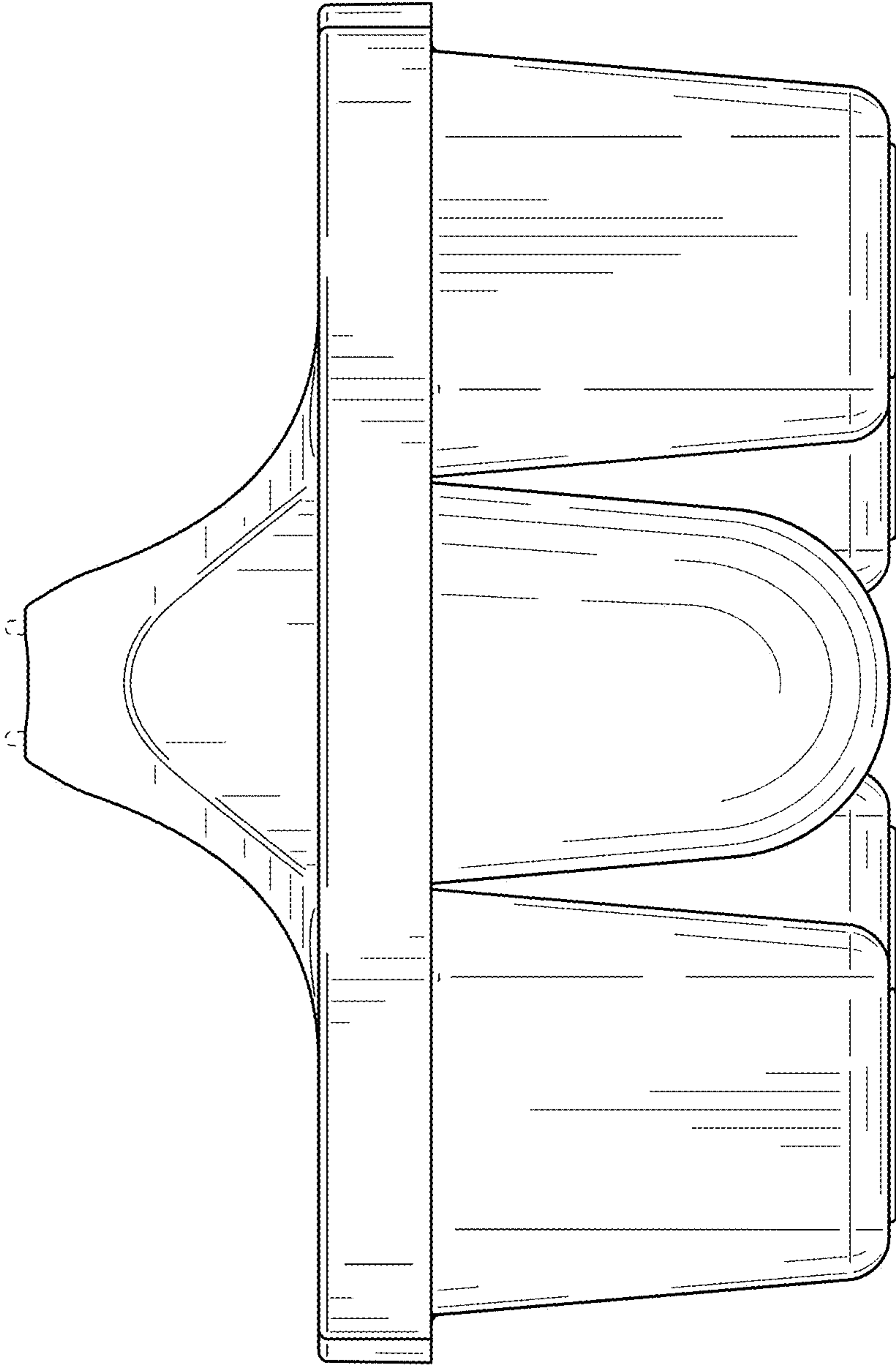

FIG. 2

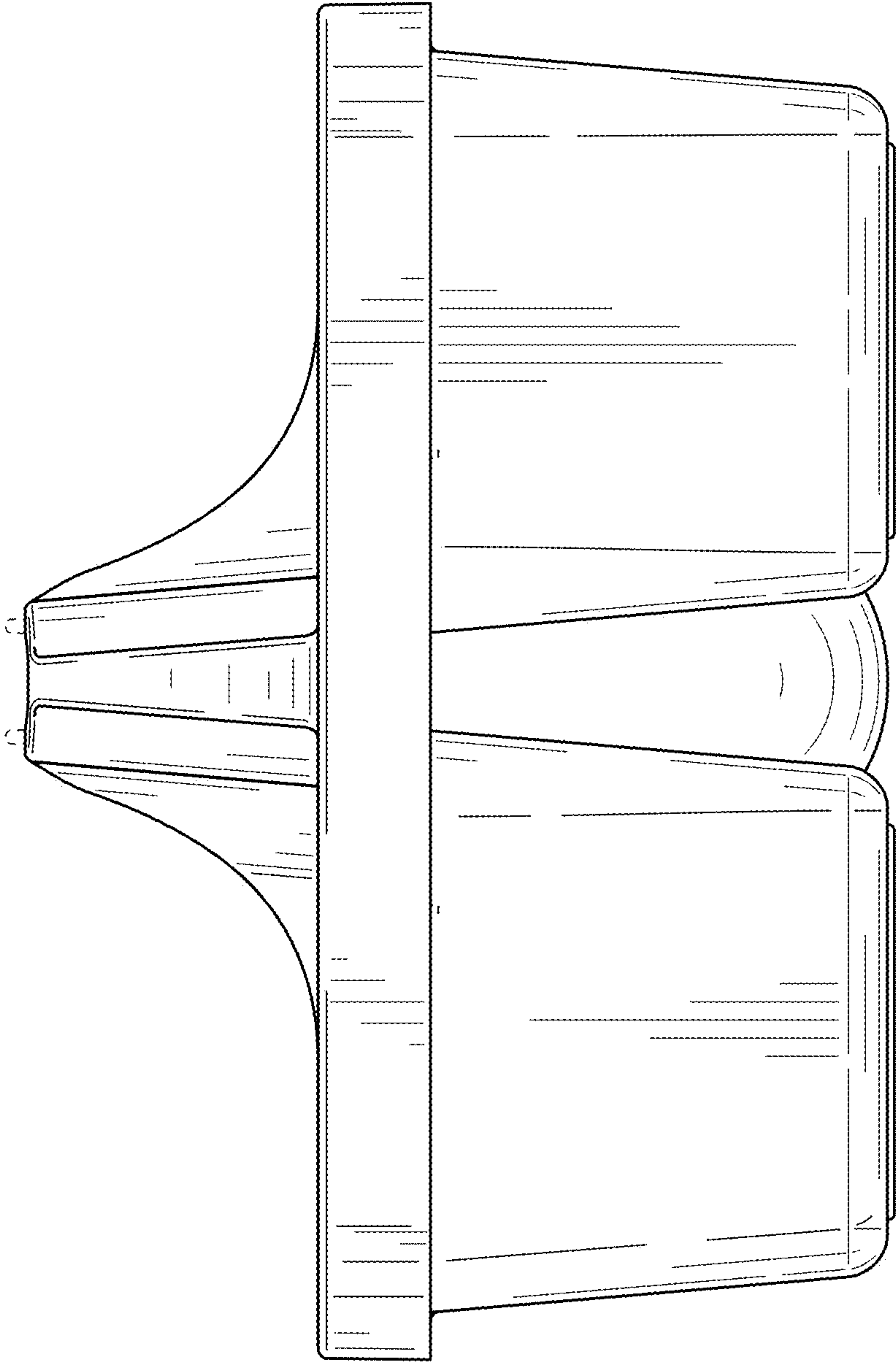

FIG. 3

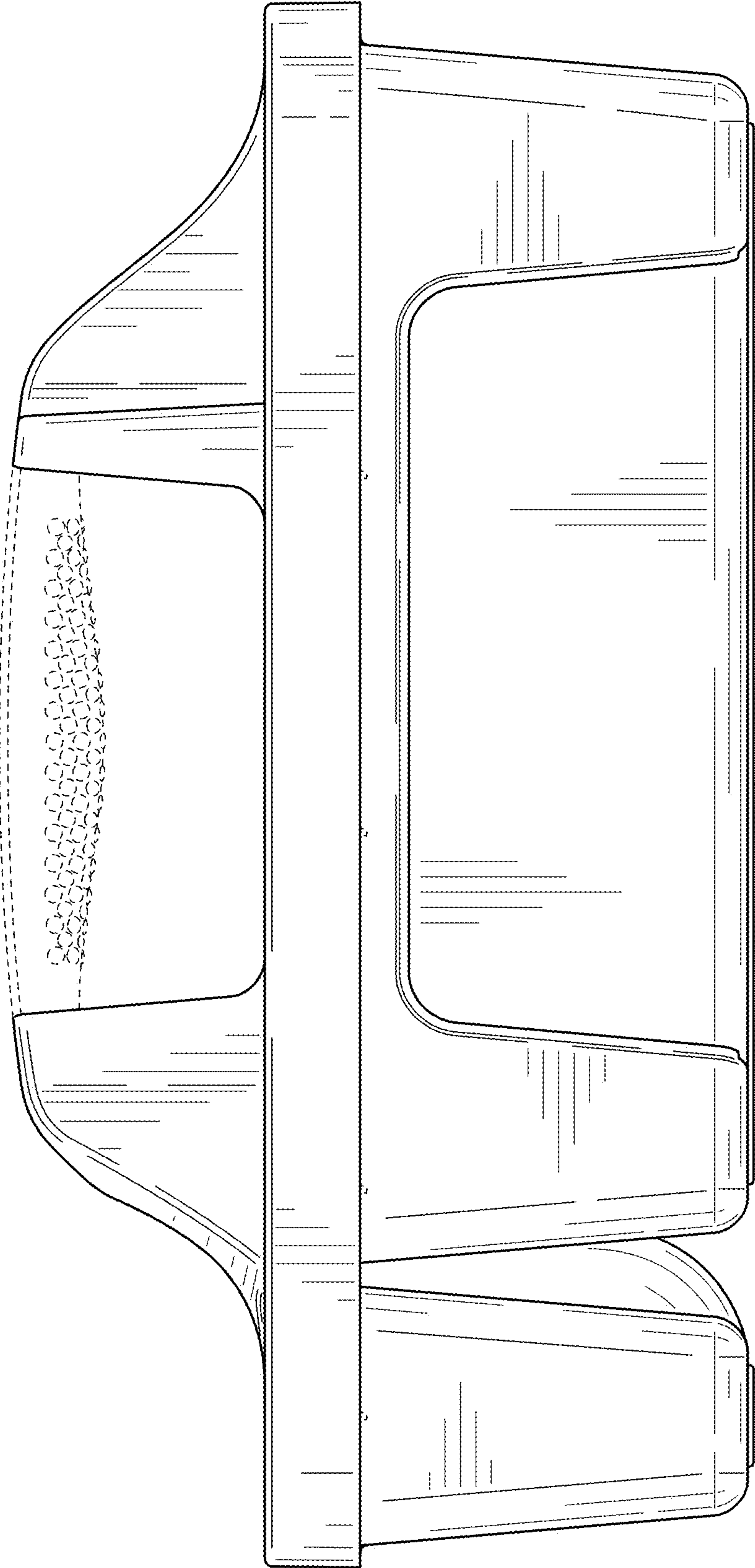

FIG. 4

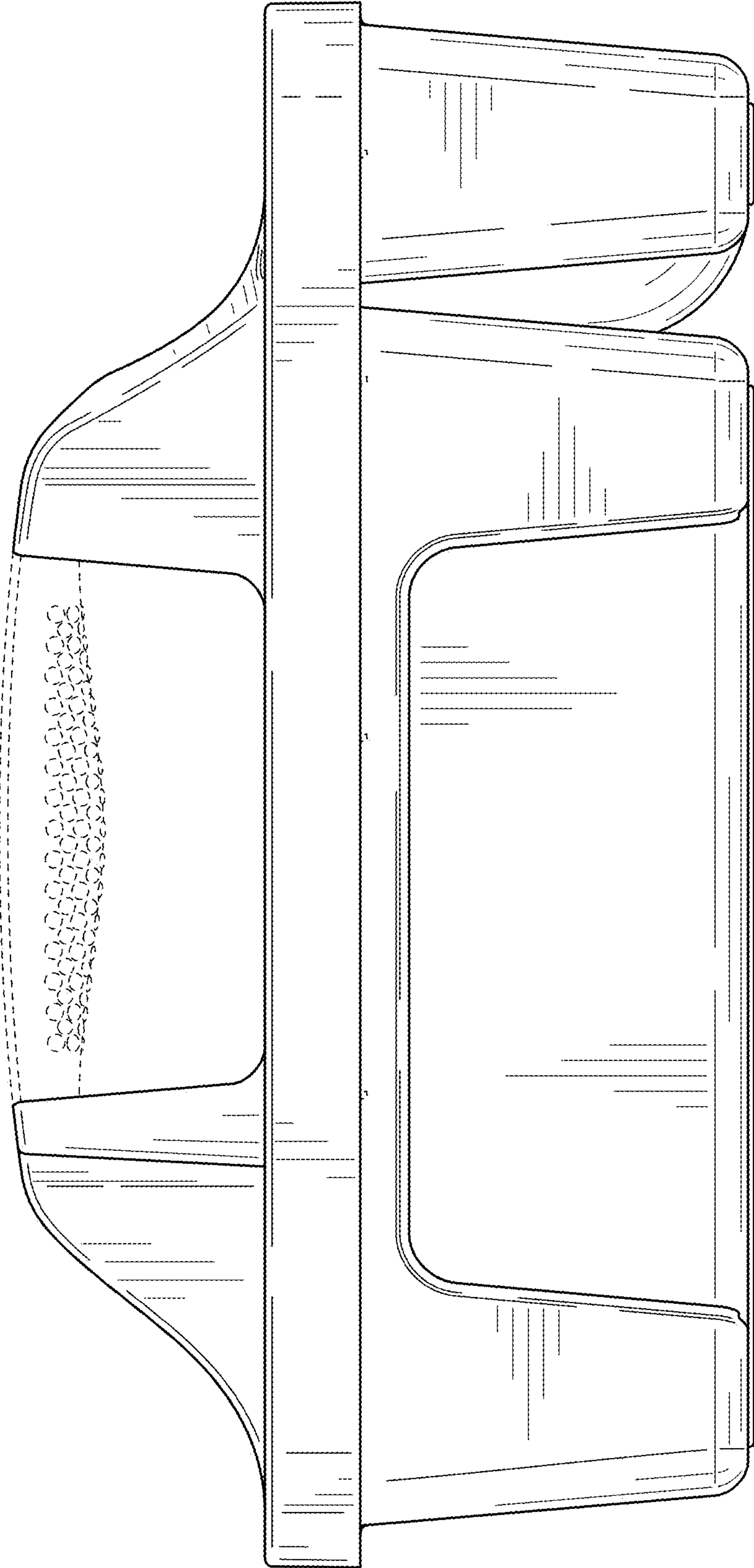

FIG. 5

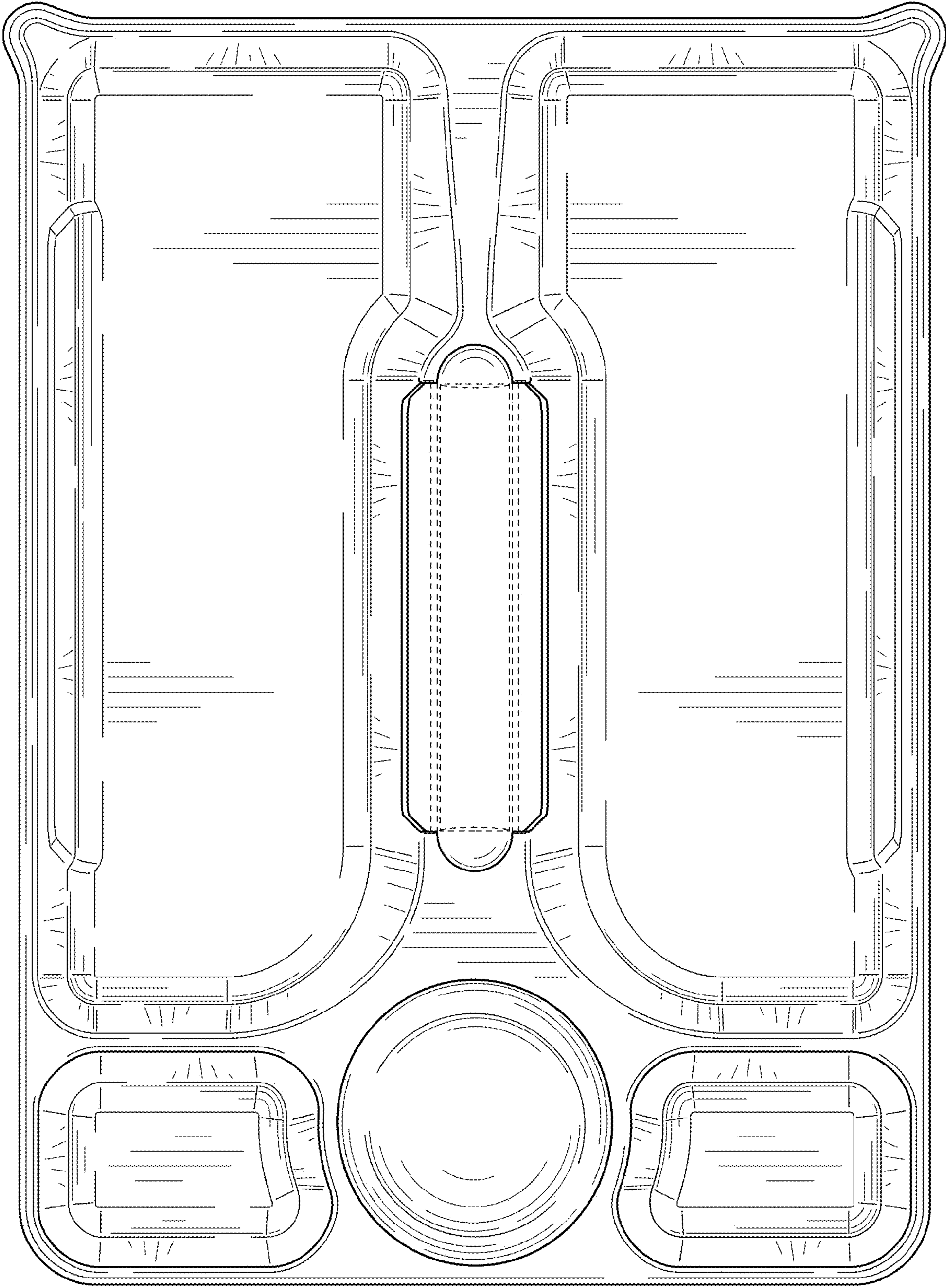

FIG. 6

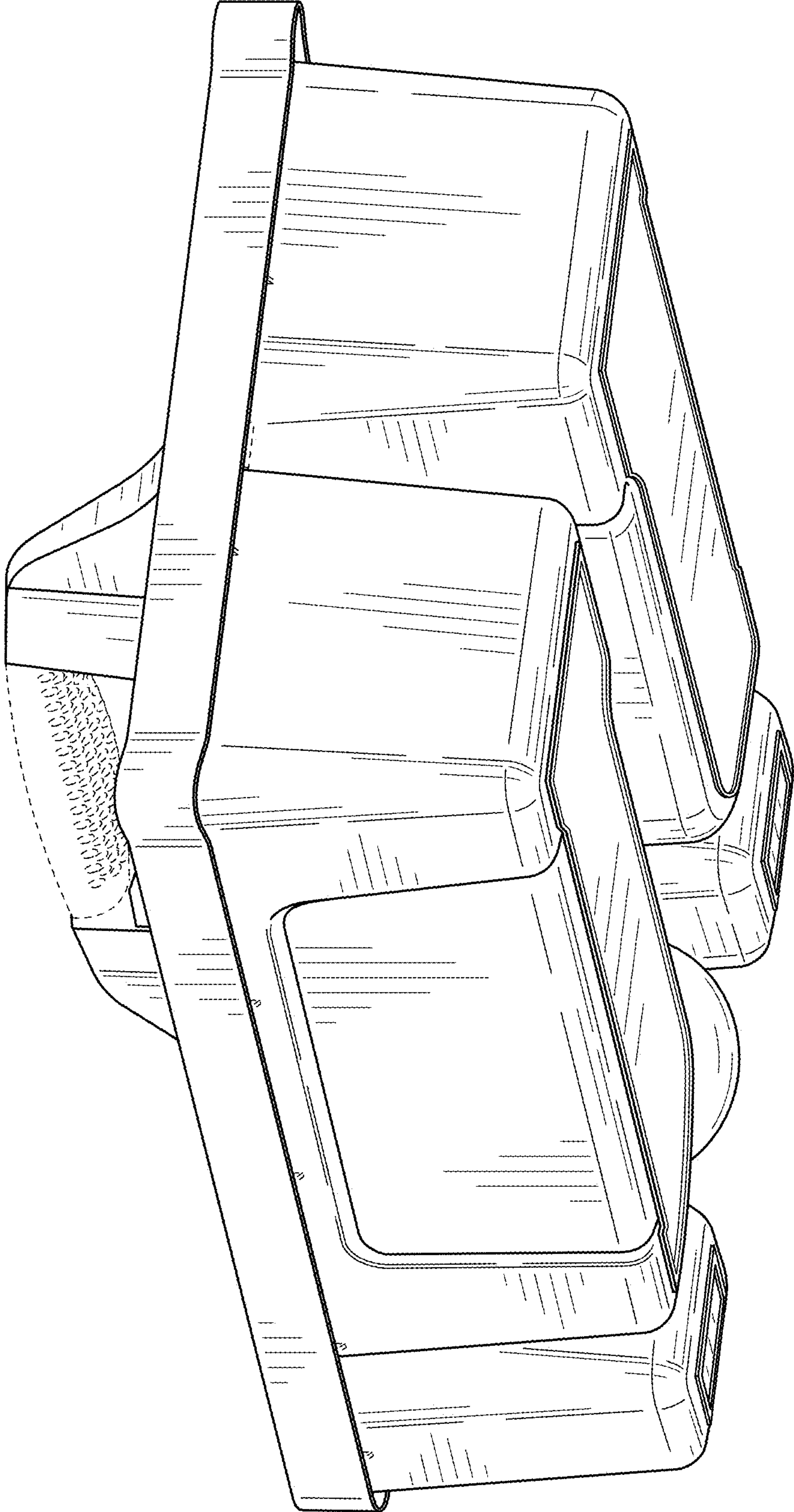

FIG. 7