

US00D876755S

(12) **United States Design Patent** (10) **Patent No.:** **US D876,755 S**
Gonzalez (45) **Date of Patent:** **** Mar. 3, 2020**

- (54) **CAP WITH FRAME FOR PHOTOGRAPH**
- (71) Applicant: **Josue Gonzalez**, Ansonia, CT (US)
- (72) Inventor: **Josue Gonzalez**, Ansonia, CT (US)
- (**) Term: **15 Years**
- (21) Appl. No.: **29/664,570**
- (22) Filed: **Sep. 26, 2018**
- (51) **LOC (12) Cl.** **02-03**
- (52) **U.S. Cl.**
USPC **D2/866; D2/882**
- (58) **Field of Classification Search**
USPC D2/865, 866, 869, 870, 871, 872, 873,
D2/874, 875, 876, 877, 878, 879, 880,
D2/881, 882, 883, 884, 885, 886, 887,
D2/888, 889, 890, 891, 892, 893, 894,
D2/895
CPC .. A42B 1/00; A42B 1/004; A42B 1/02; A42B
1/06; A42B 1/062; A42B 1/206; A42B
1/24; A42B 1/242; A42B 1/245; A42B
1/247; A42B 1/248; A42C 5/00
See application file for complete search history.

7,725,955 B1 * 6/2010 Johnson A42B 1/248
2/115
9,121,133 B2 * 9/2015 Shwartz B44C 1/105
D751,795 S 3/2016 Zenoff
(Continued)

OTHER PUBLICATIONS

Main Webpage for "High Definition Hats," [online]; [Internet publication date unknown]; [retrieved from the Internet on Oct. 29, 2019]; URL: <https://hdhatsz.com/>. (3 pgs). (Year: 2019).*

Primary Examiner — Karen S Acker
Assistant Examiner — Jasmine Mlinarcik
 (74) *Attorney, Agent, or Firm* — Michael A. Blake

(57) **CLAIM**

The ornamental design for a cap with frame for photograph, as shown and described.

DESCRIPTION

FIG. 1 is a perspective view of a cap with frame for photograph;
 FIG. 2 is a front view of the cap with frame for photograph;
 FIG. 3 is a rear view of the cap with frame for photograph;
 FIG. 4 is a first side view of the cap with frame for photograph;
 FIG. 5 is a second side view of the cap with frame for photograph;
 FIG. 6 is a top view of the cap with frame for photograph;
 and,
 FIG. 7 is a bottom view of the cap with frame for photograph.

The broken lines within the frame portion of the cap with frame for photograph depict environmental structure that forms no part of the claimed design. The broken line outline of the adjustment strap and star logo depict portions of the cap with frame for photograph that form no part of the claimed design.

(56) **References Cited**

U.S. PATENT DOCUMENTS

799,997 A	9/1905	MacLellan	
2,803,829 A	4/1954	Tscharner	
5,276,985 A	1/1994	Halloran	
5,465,426 A	11/1995	Beaton	
5,548,847 A	8/1996	Spicijaric	
D401,738 S *	12/1998	Scerbo	D2/882
D416,376 S *	11/1999	Schmalschlager	D2/869
D417,063 S *	11/1999	Henning	D2/866
6,154,992 A	12/2000	Lee	
D442,355 S *	5/2001	Rose	D2/866
7,146,649 B2 *	12/2006	Kronenbeger	A42B 1/248 2/195.1
7,490,364 B2 *	2/2009	Kim	A42B 1/248 2/209.13

1 Claim, 5 Drawing Sheets

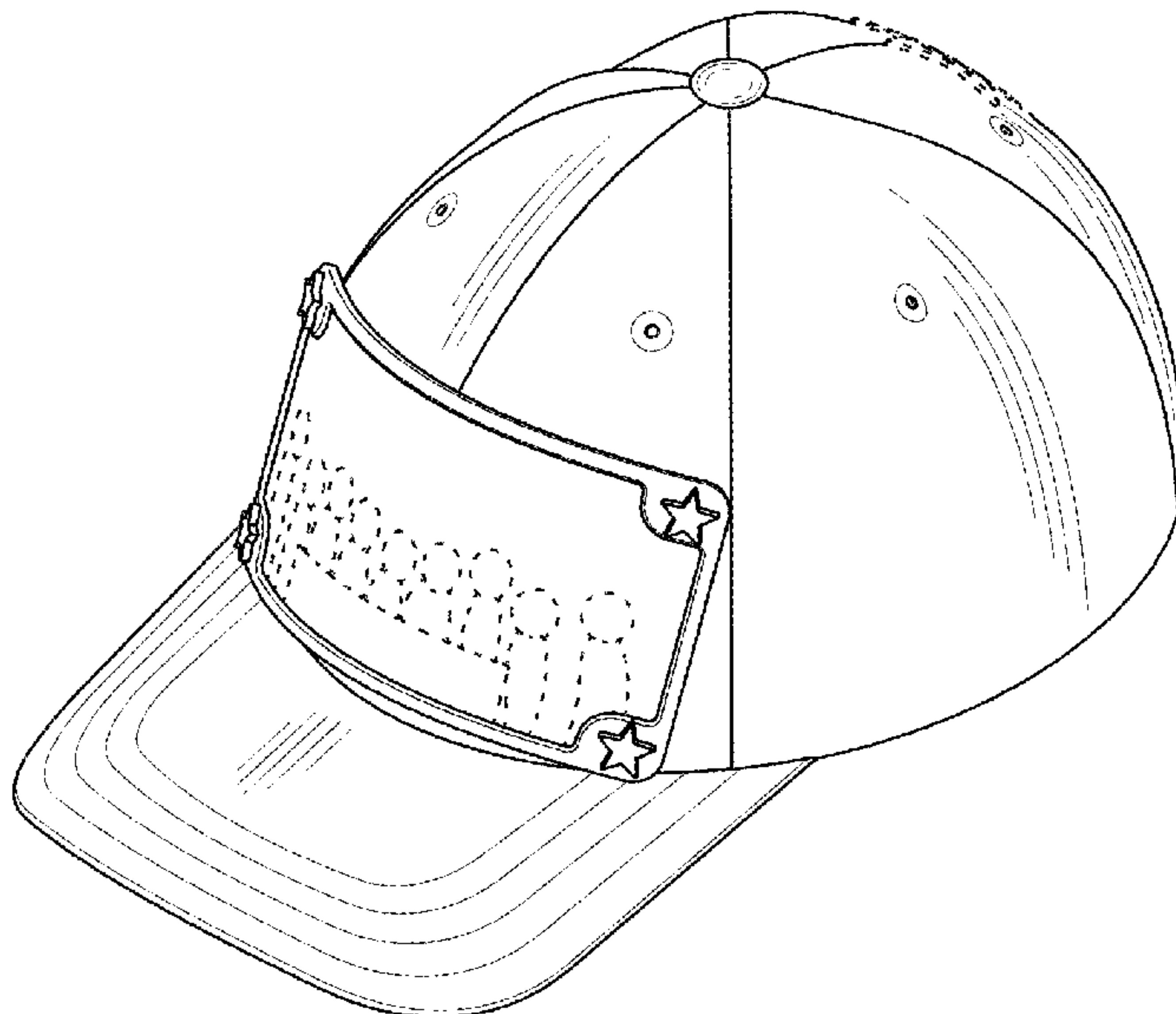

(56)

References Cited

U.S. PATENT DOCUMENTS

D774,283 S *	12/2016	Rollins	D2/882
D831,310 S *	10/2018	Agnese	D2/882
2004/0205878 A1	10/2004	Goldsby	
2008/0141567 A1*	6/2008	Chen	A42B 1/248 40/1.5

* cited by examiner

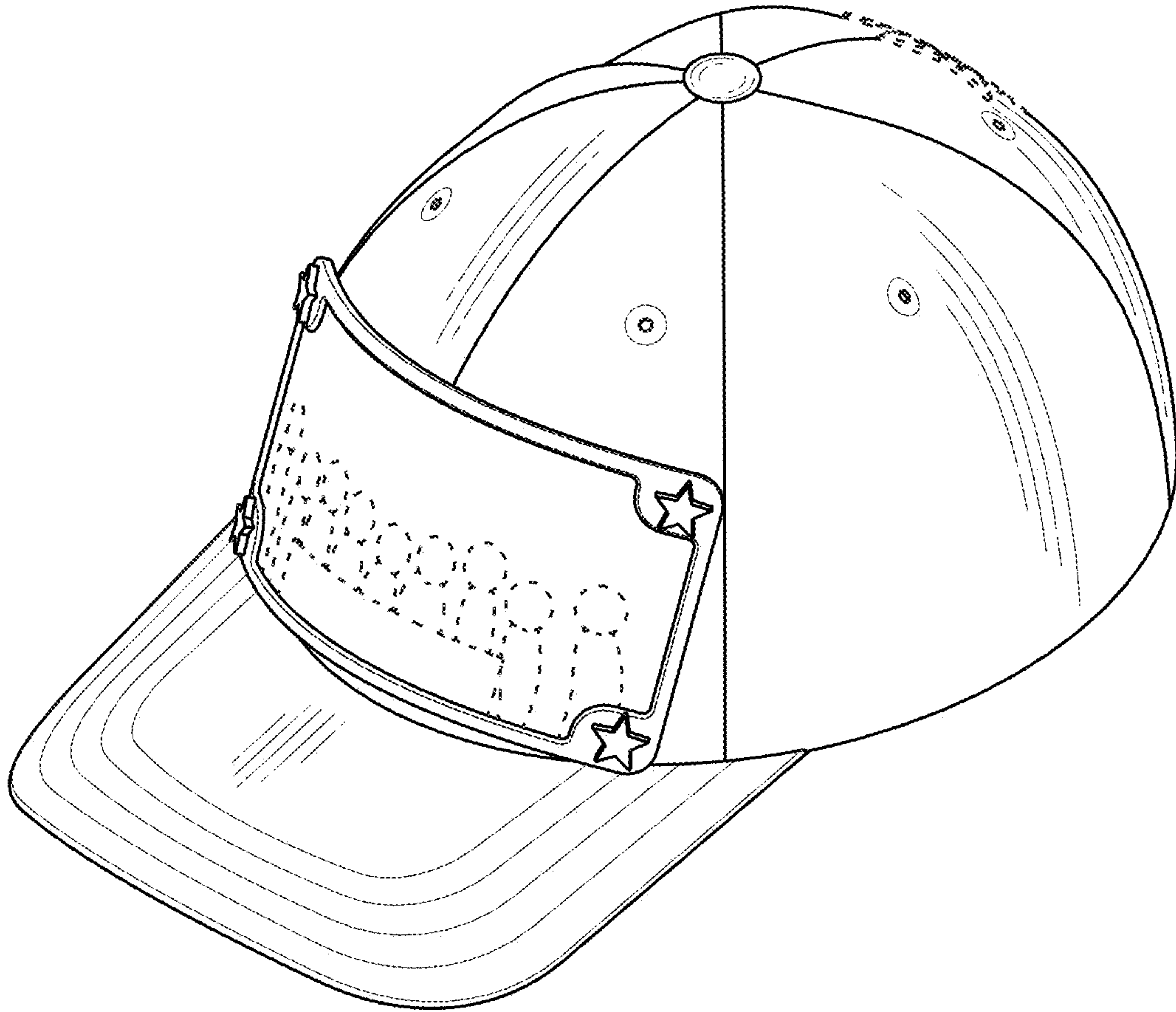

FIG. 1

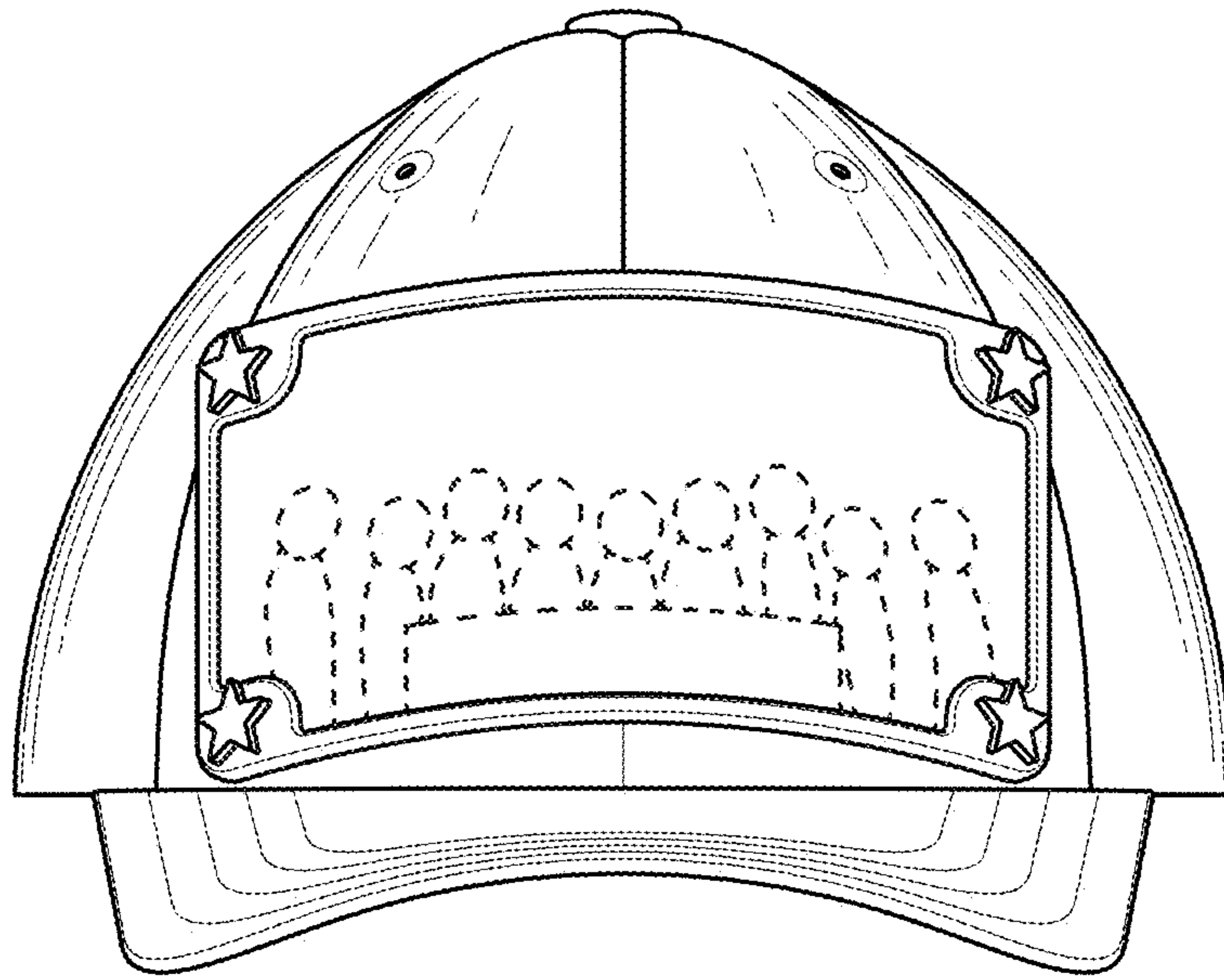

FIG. 2

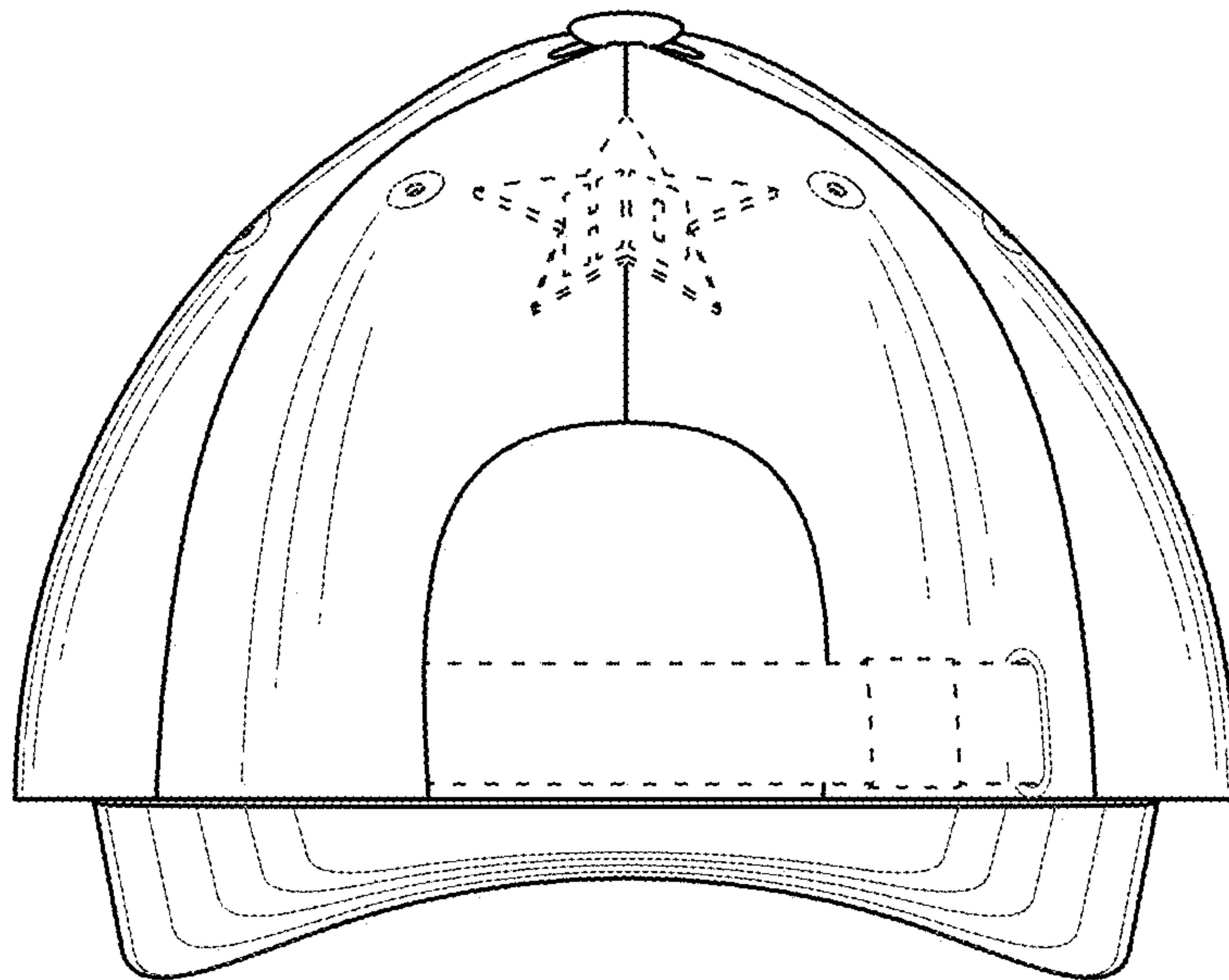

FIG. 3

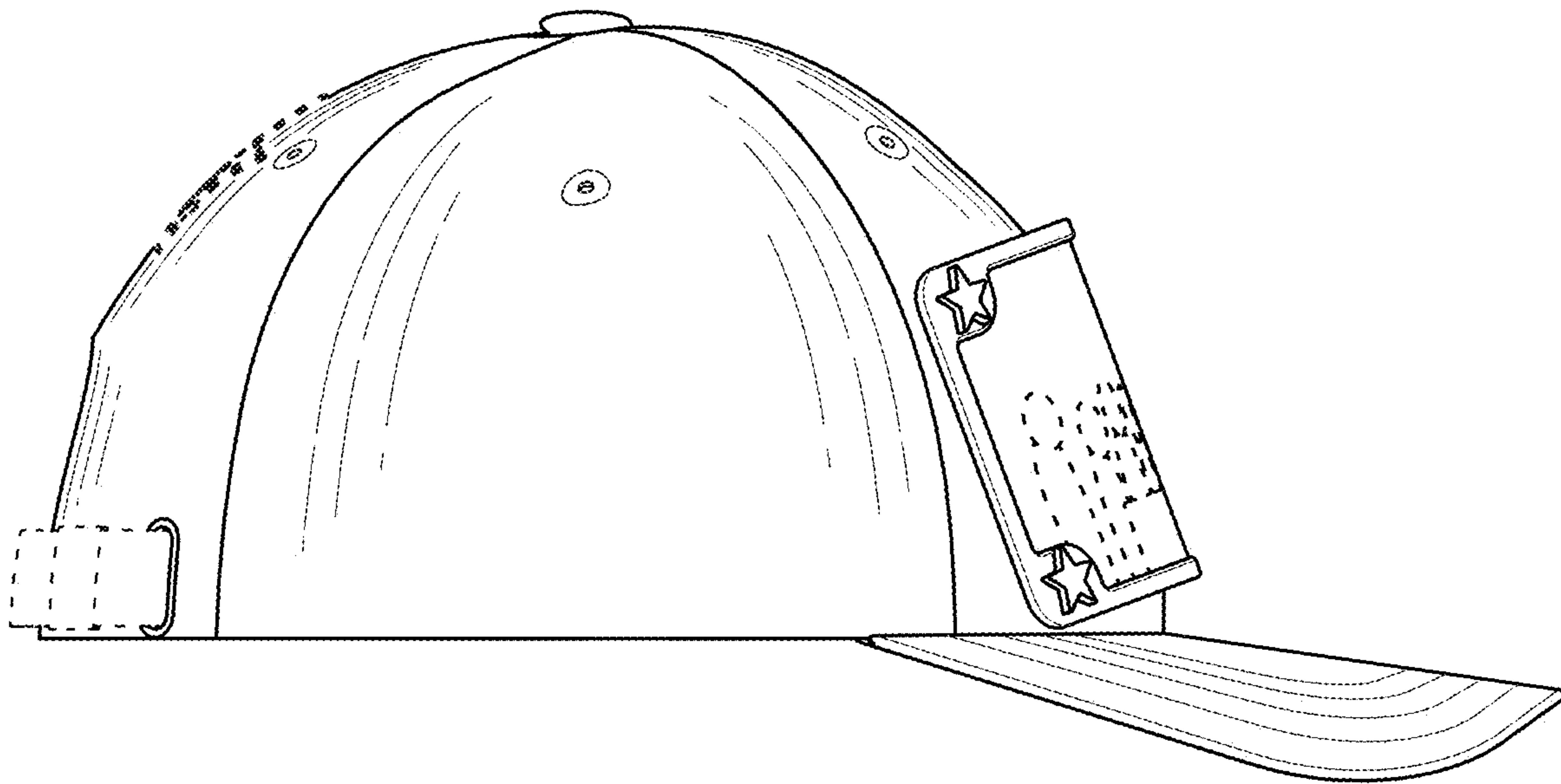

FIG. 4

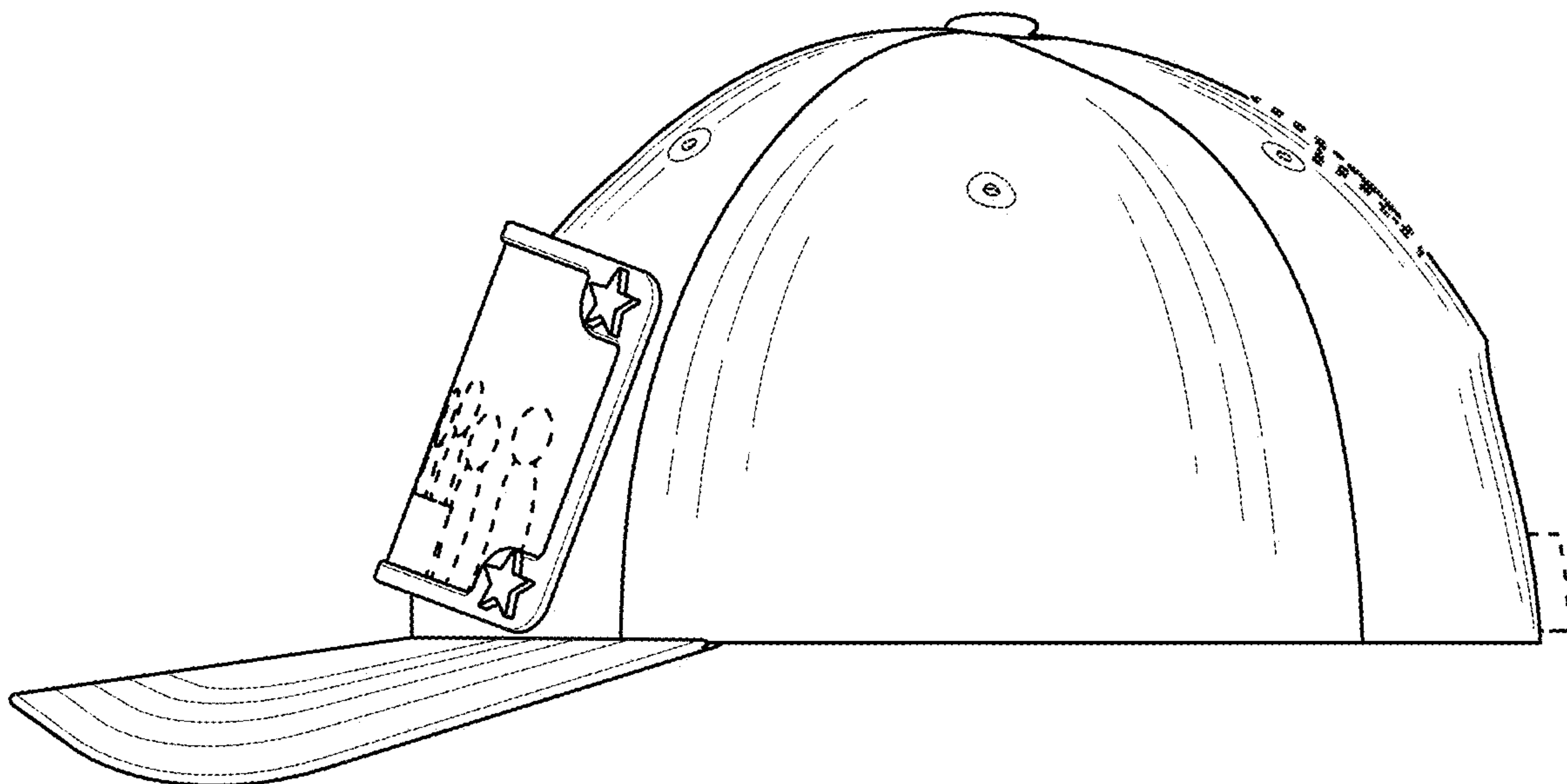

FIG. 5

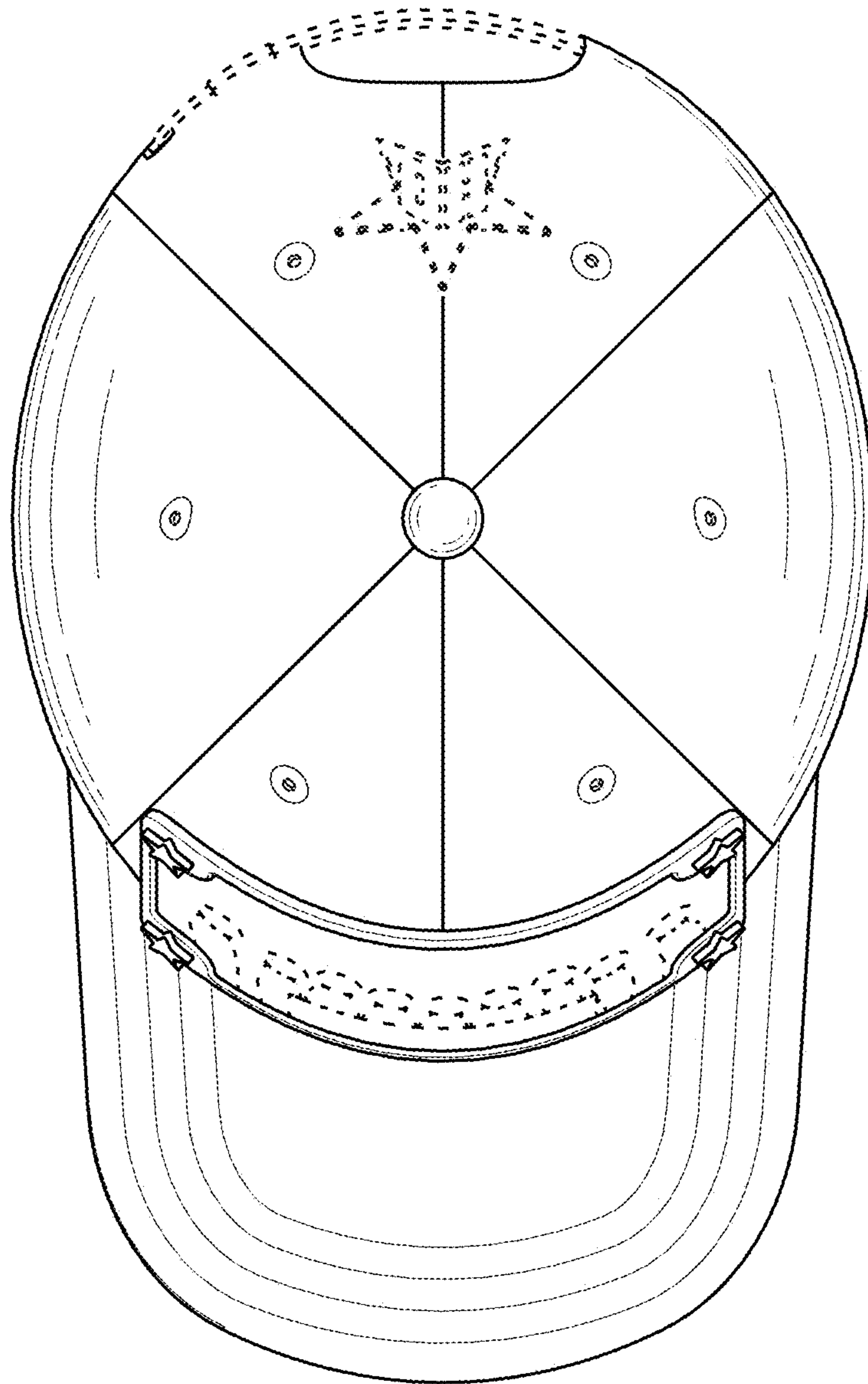

FIG. 6

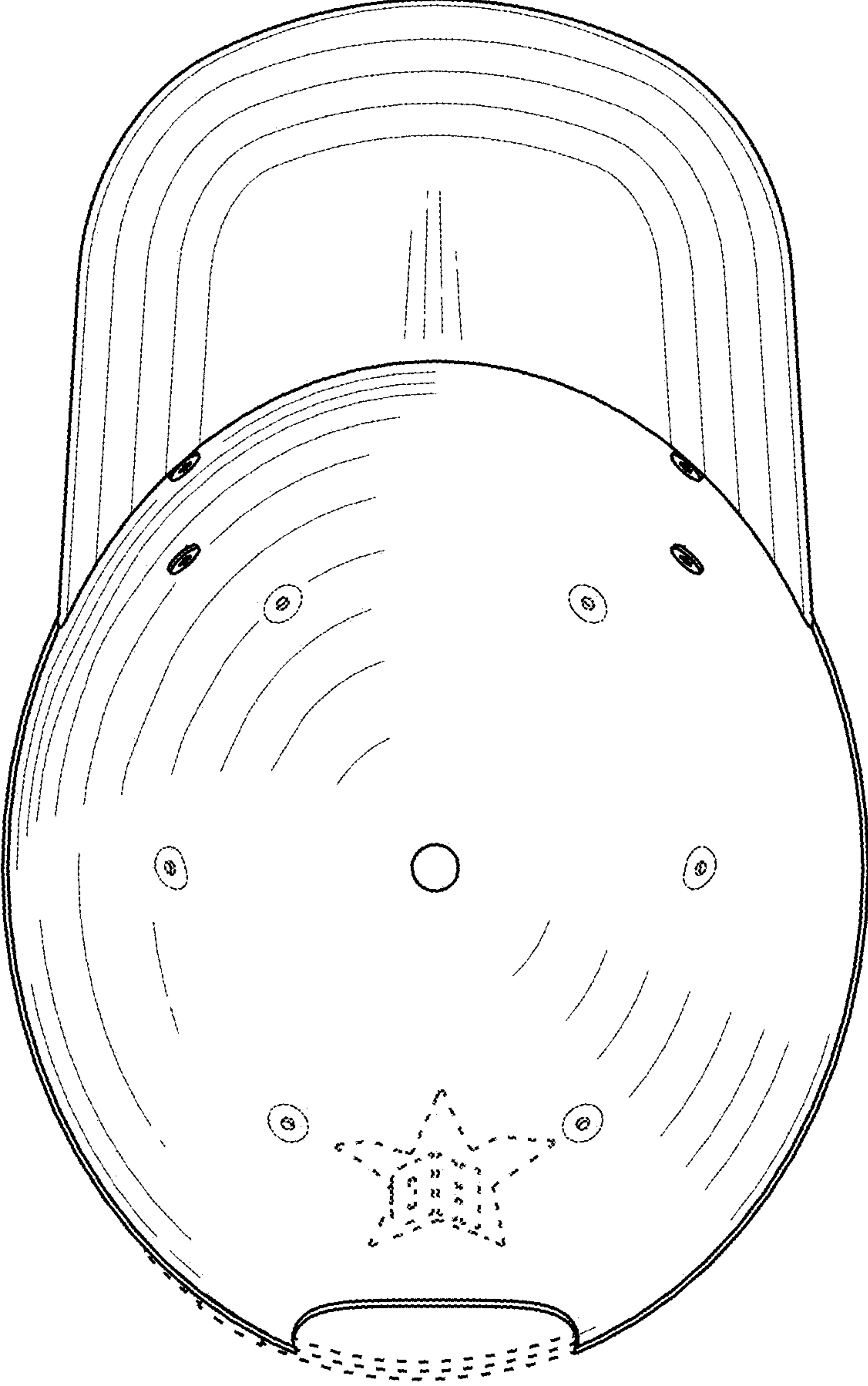

FIG. 7