



US00D876742S

(12) **United States Design Patent**
Pollard

(10) **Patent No.:** **US D876,742 S**

(45) **Date of Patent:** **** Feb. 25, 2020**

(54) **PAINTBRUSH HOLDER**

(71) Applicant: **Timothy Pollard**, Penrose, CA (US)

(72) Inventor: **Timothy Pollard**, Penrose, CA (US)

(**) Term: **15 Years**

(21) Appl. No.: **29/657,592**

(22) Filed: **Jul. 24, 2018**

(51) **LOC (12) Cl.** **07-05**

(52) **U.S. Cl.**
USPC **D32/54**

(58) **Field of Classification Search**
USPC D32/53, 53.1, 54; D3/304, 307, 315
CPC B44D 3/123; B44D 3/128; B44D 3/12;
A47L 13/142; A47L 13/58; B65D 25/14
See application file for complete search history.

(56) **References Cited**

U.S. PATENT DOCUMENTS

D300,970 S *	5/1989	Walker	D32/53
5,076,519 A	12/1991	Panovic	
D327,148 S *	6/1992	Alessi	D32/54
D341,686 S *	11/1993	Panovic	D32/54
5,261,577 A *	11/1993	Goldstein	B44D 3/12 220/23.83
D346,054 S *	4/1994	Spangler	D32/54
5,322,183 A	6/1994	Strachan	
D358,914 S *	5/1995	Masse	D32/54
D405,574 S *	2/1999	Riky	D32/54
6,237,802 B1	5/2001	Douglas	

D444,278 S *	6/2001	Myers, Jr.	D32/54
6,446,829 B1	9/2002	Malvasio	
D473,689 S	4/2003	Verhaar	
6,929,225 B1	8/2005	Kent	
D535,794 S *	1/2007	Lundy	D32/53.1
D586,969 S	2/2009	Graham	
D845,572 S *	4/2019	Pollard	D32/54
2003/0204929 A1 *	11/2003	Rougeau	B44D 3/12 15/257.06
2014/0144797 A1 *	5/2014	Lareau	B44D 3/123 206/361

* cited by examiner

Primary Examiner — Sheryl Lane
Assistant Examiner — Calvin E Vansant

(57) **CLAIM**

I claim the ornamental design for a paintbrush holder, as shown and described.

DESCRIPTION

FIG. 1 is a front view of the paintbrush holder.
FIG. 2 is a rear view of the claimed design.
FIG. 3 is a left side view of the claimed design.
FIG. 4 is a right side view of the claimed design.
FIG. 5 is a top view of the claimed design.
FIG. 6 is a bottom view of the claimed design; and,
FIG. 7 is a perspective view of the claimed design as appears on a paint can.
The broken lines appearing on FIG. 7 of a paint can and paintbrush are environmental matter forming no part of the claimed design.

1 Claim, 3 Drawing Sheets

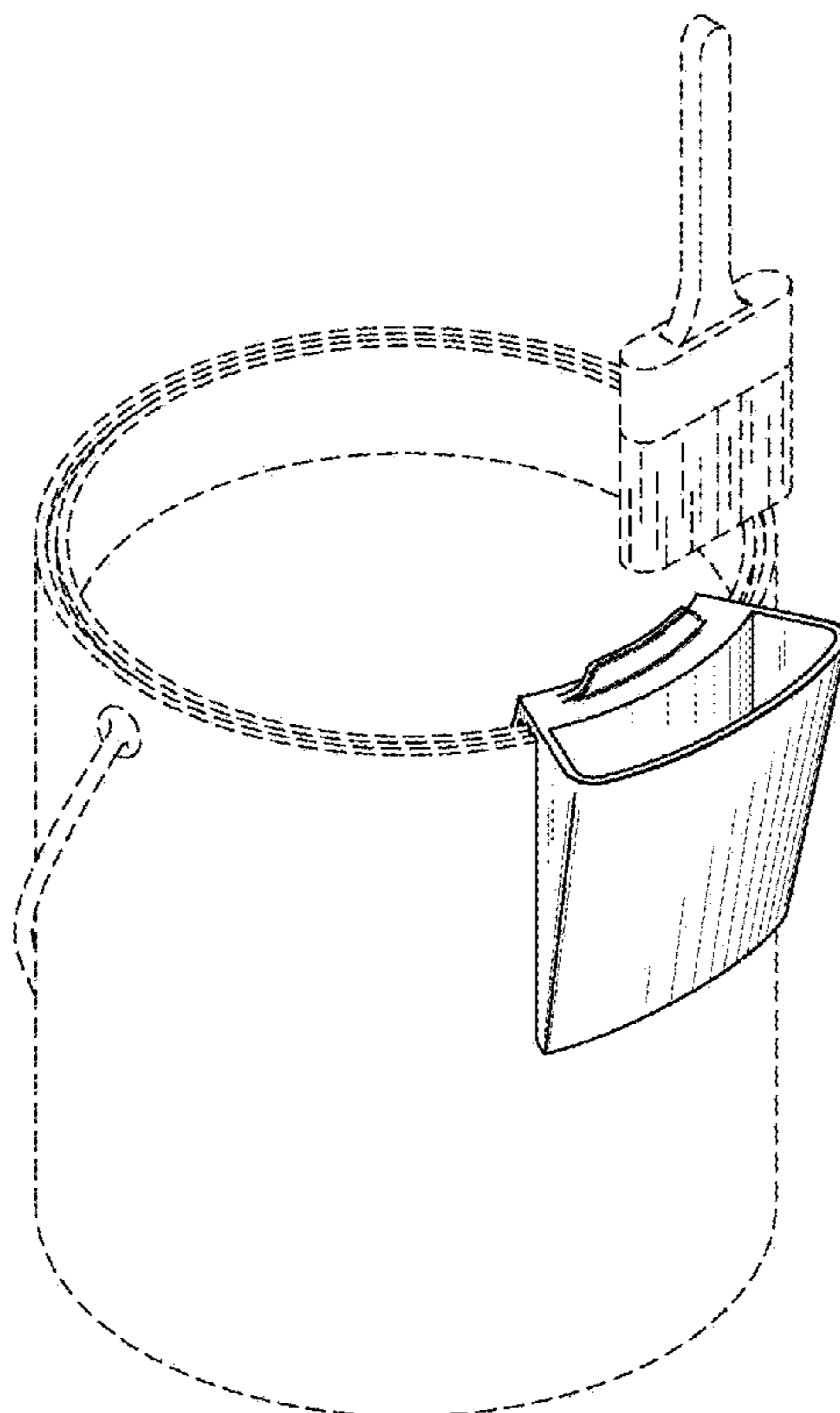

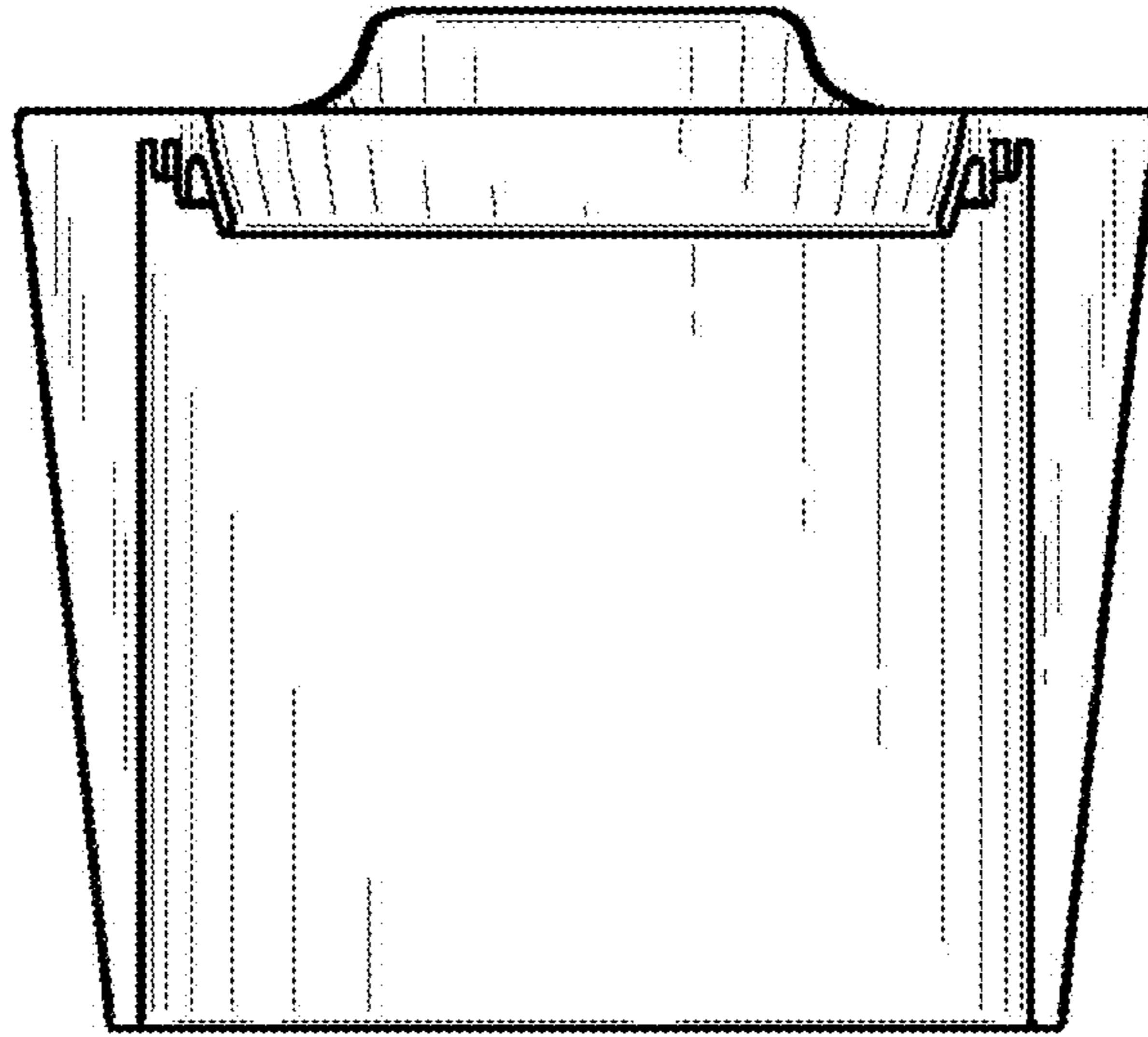

FIG. 1

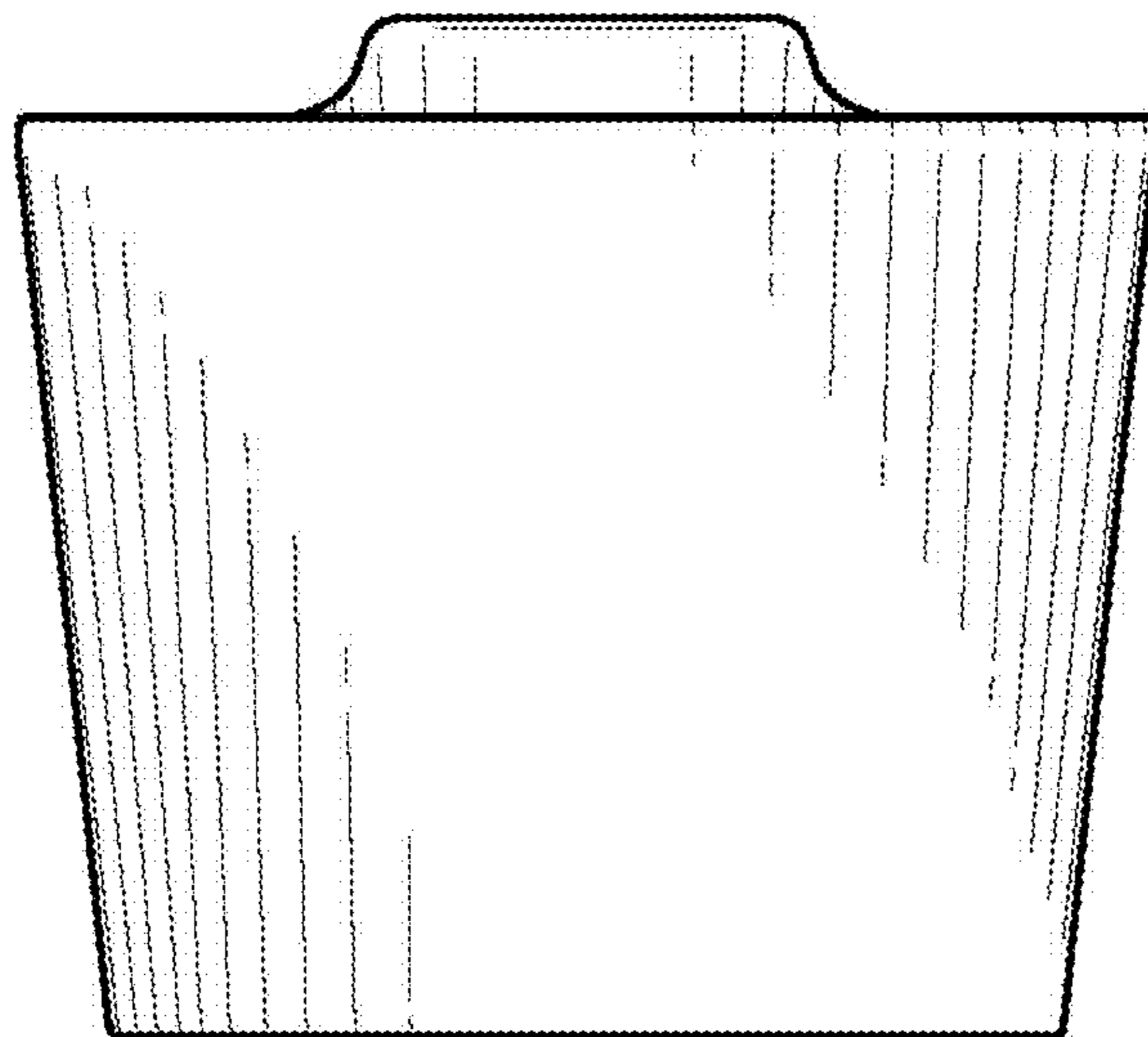

FIG. 2

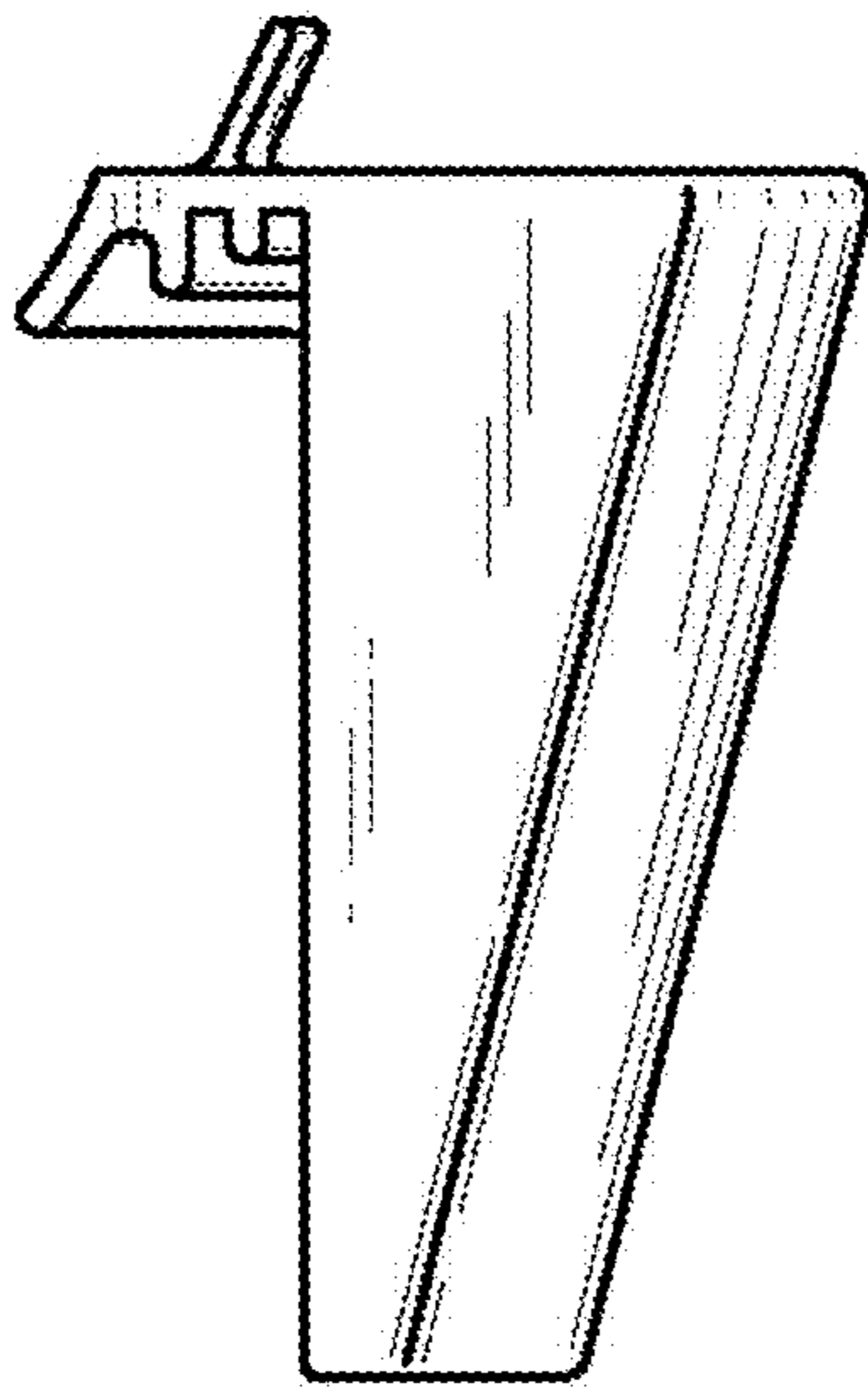

FIG. 3

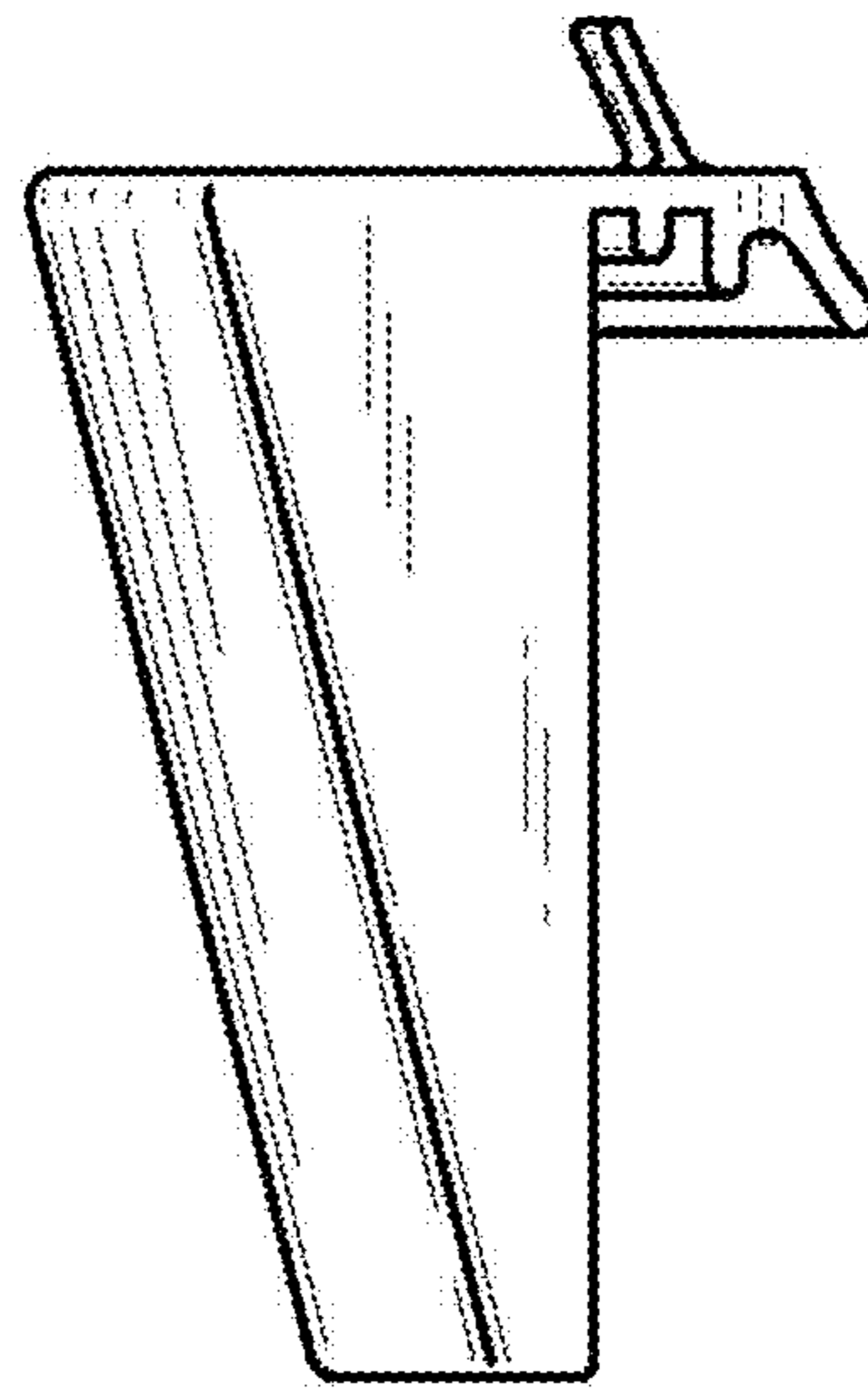

FIG. 4

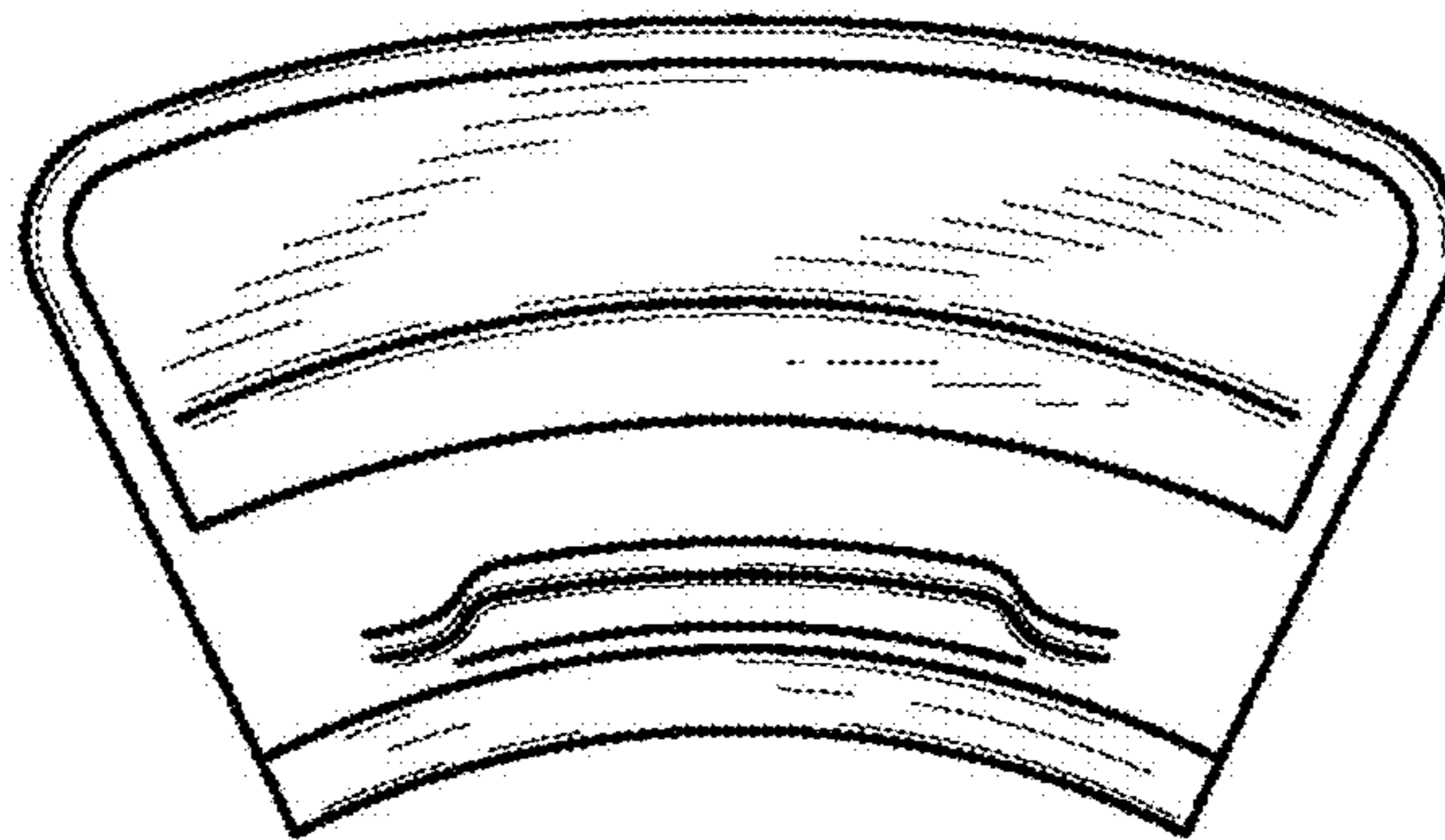

FIG. 5

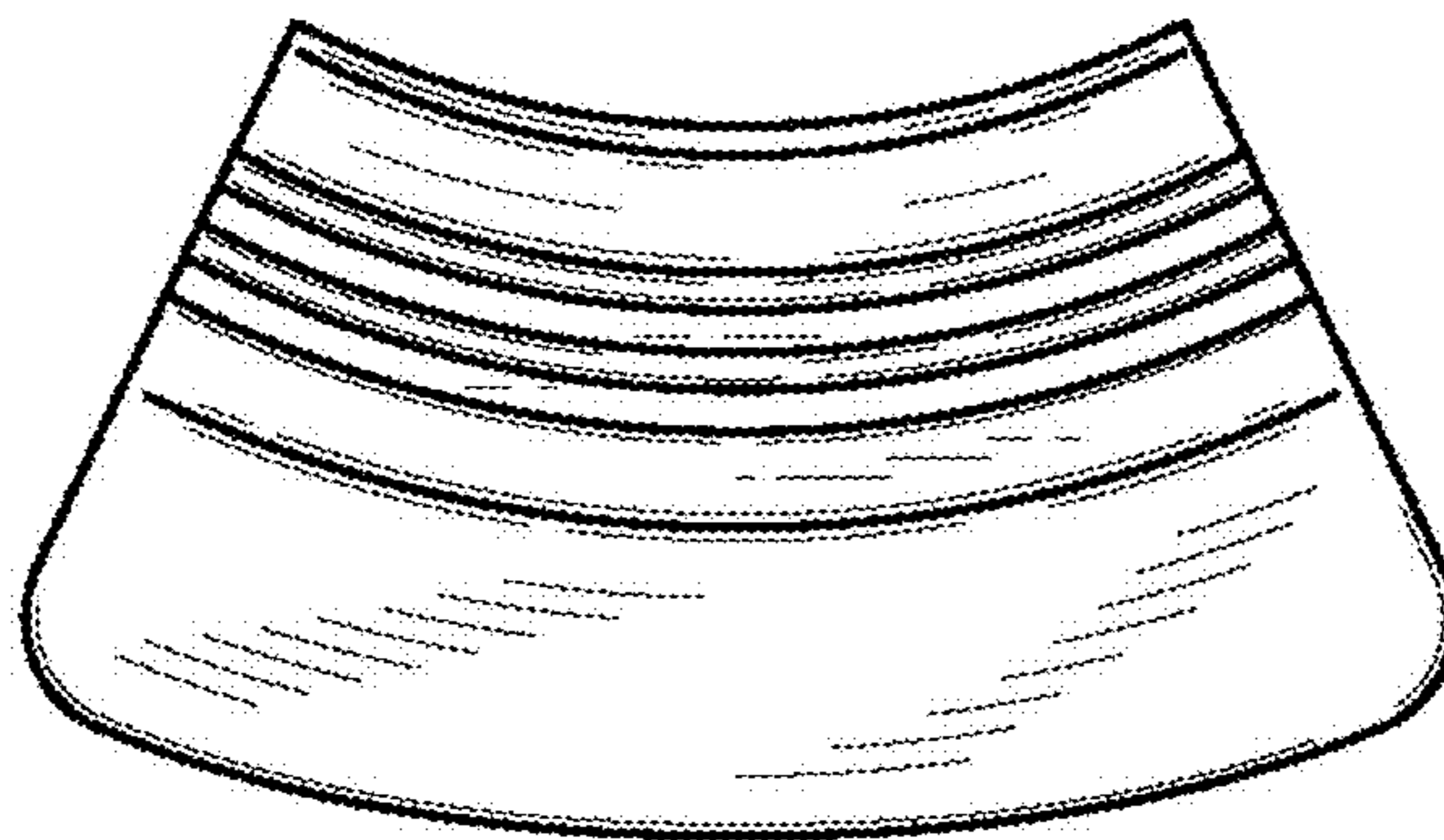

FIG. 6

FIG. 7

