



US00D876673S

(12) **United States Design Patent**  
**Chang et al.**

(10) **Patent No.:** **US D876,673 S**  
(45) **Date of Patent:** **\*\* Feb. 25, 2020**

(54) **PLANK UNIT**

**DESCRIPTION**

(71) Applicants: **Chia-Ming Chang**, Longtan Township (TW); **Chi-Hui Chang**, Longtan Township (TW); **Pei-Chia Hsu**, Longtan Township (TW)

(72) Inventors: **Chia-Ming Chang**, Longtan Township (TW); **Chi-Hui Chang**, Longtan Township (TW); **Pei-Chia Hsu**, Longtan Township (TW)

(\*\*) Term: **15 Years**

(21) Appl. No.: **29/621,525**

(22) Filed: **Oct. 9, 2017**

(30) **Foreign Application Priority Data**

Aug. 31, 2017 (CN) ..... 2017 3 0407509

(51) **LOC (12) Cl.** ..... **25-01**

(52) **U.S. Cl.**  
USPC ..... **D25/138**

(58) **Field of Classification Search**  
USPC ..... D25/112, 113, 138, 139, 140, 144, 149,  
D25/150, 151, 157, 163, 164, 160  
(Continued)

(56) **References Cited**

**U.S. PATENT DOCUMENTS**

8,061,104 B2 \* 11/2011 Pervan ..... E04F 15/02  
52/591.1  
8,234,830 B2 \* 8/2012 Pervan ..... E04F 13/0894  
52/582.1

(Continued)

*Primary Examiner* — Kevin K Rudzinski

*Assistant Examiner* — Kimberly Barnes

(74) *Attorney, Agent, or Firm* — Wang Law Firm, Inc.

(57) **CLAIM**

The ornamental design for a plank unit, as shown and described.

FIG. 1 is a perspective view of a plank unit showing a first embodiment of our new design;  
FIG. 2 is a front view thereof;  
FIG. 3 is a rear view thereof;  
FIG. 4 is a left view thereof;  
FIG. 5 is a right view thereof;  
FIG. 6 is a top view thereof;  
FIG. 7 is a bottom view thereof;  
FIG. 8 is a perspective view of a plank unit showing a second embodiment of our new design;  
FIG. 9 is a front view thereof;  
FIG. 10 is a rear view thereof;  
FIG. 11 is a left view thereof;  
FIG. 12 is a right view thereof;  
FIG. 13 is a top view thereof;  
FIG. 14 is a bottom view thereof;  
FIG. 15 is a perspective view of a plank unit showing a third embodiment of our new design;  
FIG. 16 is a front view thereof;  
FIG. 17 is a rear view thereof;  
FIG. 18 is a left view thereof;  
FIG. 19 is a right view thereof;  
FIG. 20 is a top view thereof;  
FIG. 21 is a bottom view thereof;  
FIG. 22 is a perspective view of a plank unit showing a fourth embodiment of our new design;  
FIG. 23 is a front view thereof;  
FIG. 24 is a rear view thereof;  
FIG. 25 is a left view thereof;  
FIG. 26 is a right view thereof;  
FIG. 27 is a top view thereof; and,  
FIG. 28 is a bottom view thereof.  
The plank unit is shown with a symbolic break in its length and width. The appearance of any portion of the article between the break lines forms no part of the claimed design.

**1 Claim, 28 Drawing Sheets**

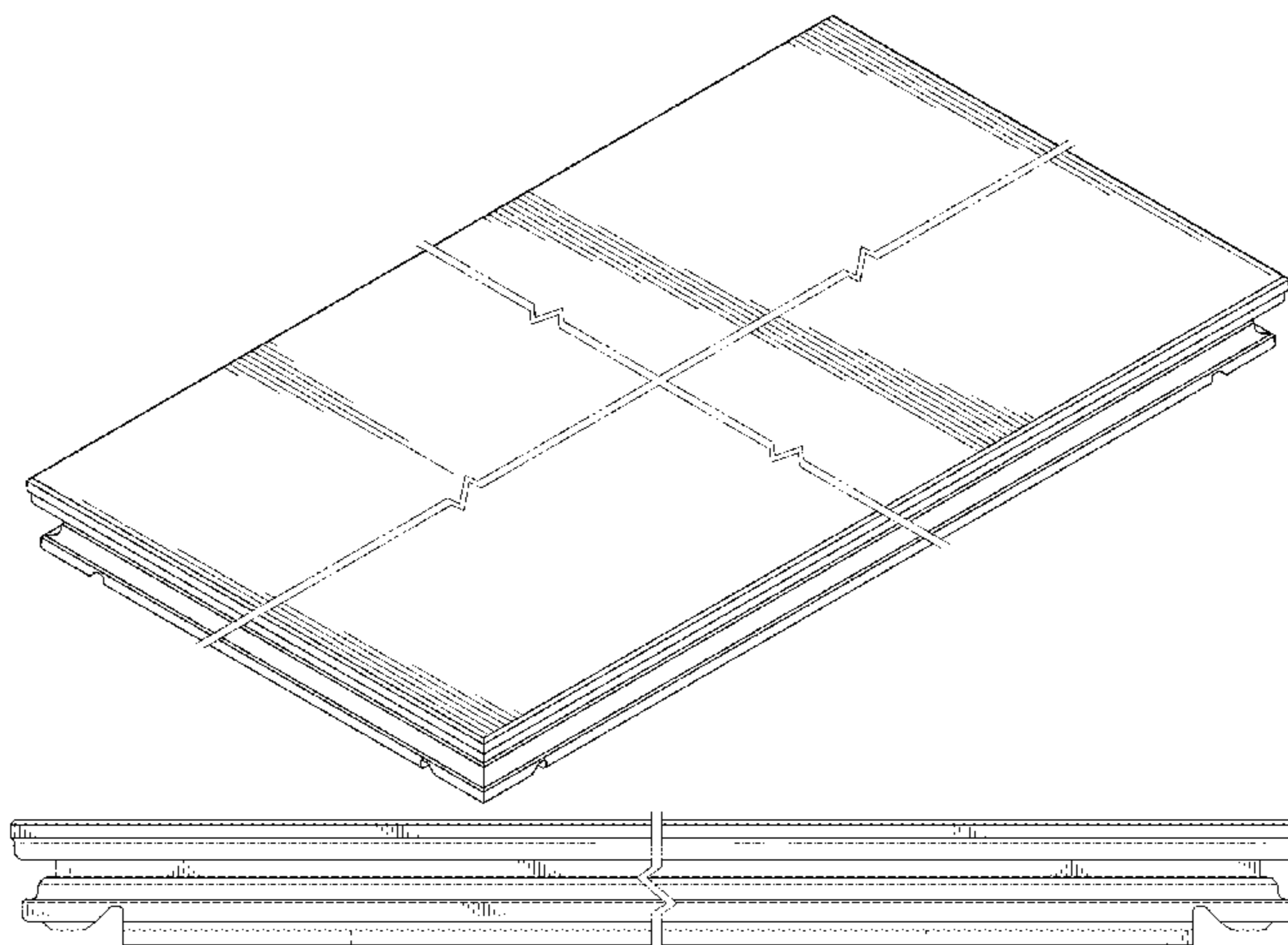

(58) **Field of Classification Search**  
 CPC ..... E04B 5/02; E04B 2002/0226; E04B  
 2002/0228; E04B 2002/0232; E04F  
 15/02; E04F 15/02038; E04F 2015/02094  
 See application file for complete search history.

8,769,905 B2 \* 7/2014 Pervan ..... E04F 15/02038  
 52/582.1  
 8,776,473 B2 \* 7/2014 Pervan ..... E04F 13/0894  
 52/586.1  
 8,938,929 B2 \* 1/2015 Engstrom ..... E04F 15/02038  
 52/586.2  
 8,991,055 B2 \* 3/2015 Cappelle ..... E04F 15/02  
 29/897.32  
 9,194,134 B2 \* 11/2015 Nygren ..... E04F 15/02038  
 9,617,741 B2 \* 4/2017 Devos ..... E04C 2/38  
 10,017,948 B2 \* 7/2018 Boo ..... E04F 15/102  
 10,214,916 B2 \* 2/2019 Schulte ..... E04F 15/02038  
 10,214,918 B2 \* 2/2019 Cappelle ..... E04F 15/02038  
 10,301,830 B2 \* 5/2019 Boo ..... E04F 15/02038  
 2004/0250492 A1 \* 12/2004 Becker ..... E04F 15/04  
 52/578  
 2017/0175400 A1 \* 6/2017 Josefsson ..... E04F 13/0894  
 2019/0017278 A1 \* 1/2019 De Rick ..... E04F 15/105  
 2019/0136545 A1 \* 5/2019 De Rick ..... E04F 15/02038  
 2019/0316364 A1 \* 10/2019 Wang ..... E04F 15/087

(56) **References Cited**  
 U.S. PATENT DOCUMENTS

8,381,477 B2 \* 2/2013 Pervan ..... E04F 15/02038  
 52/586.2  
 8,572,922 B2 \* 11/2013 Pervan ..... E04F 15/02  
 52/582.1  
 8,615,953 B2 \* 12/2013 Cappelle ..... E04F 15/02038  
 52/588.1  
 8,689,512 B2 \* 4/2014 Pervan ..... E04F 15/02  
 52/586.1  
 8,726,513 B2 \* 5/2014 Braun ..... B27F 5/02  
 144/371

\* cited by examiner

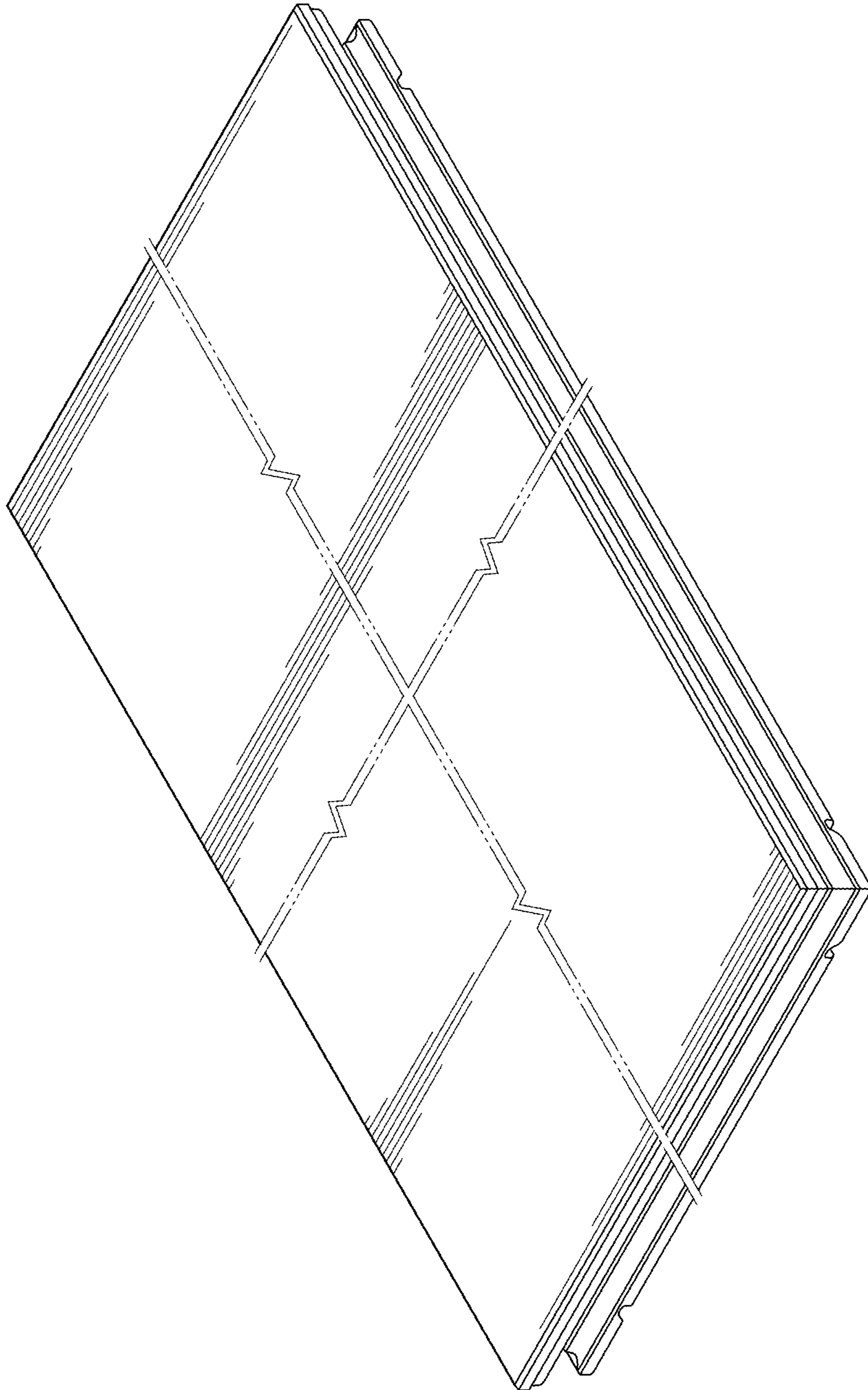

FIG. 1

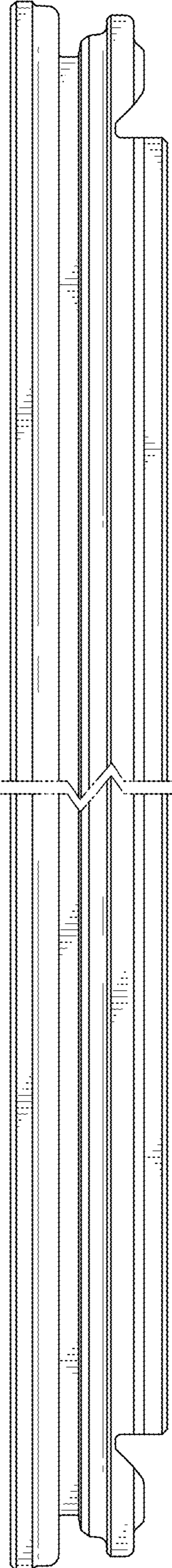

FIG. 2

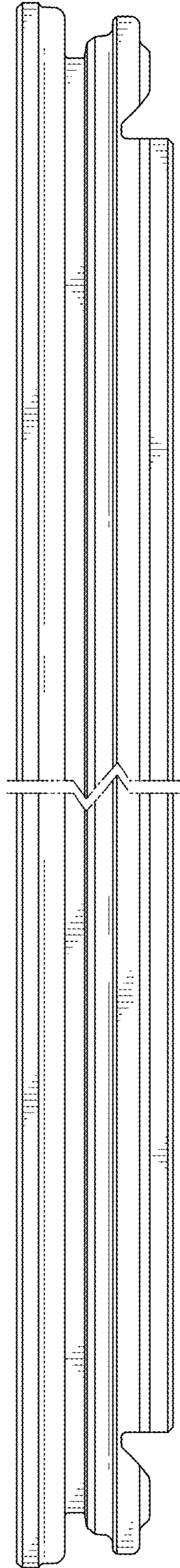

FIG. 3

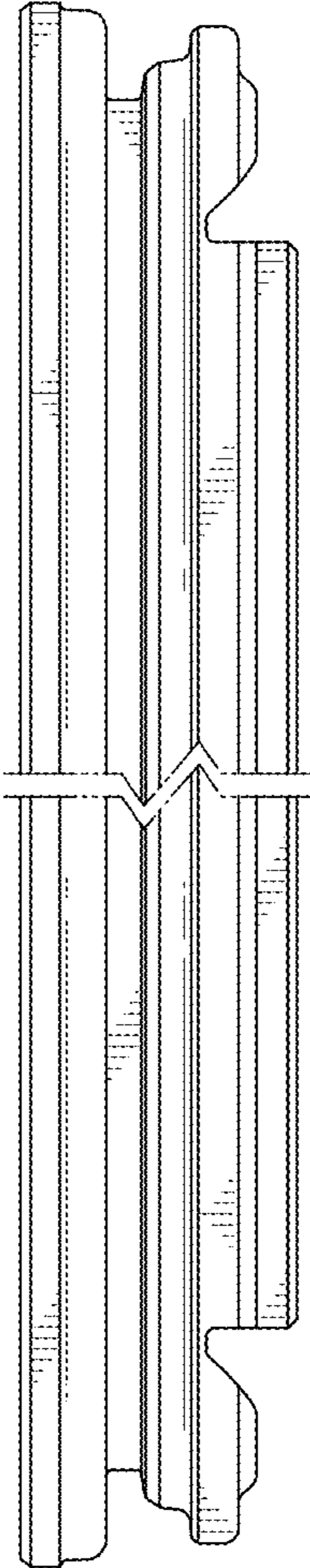

FIG. 4

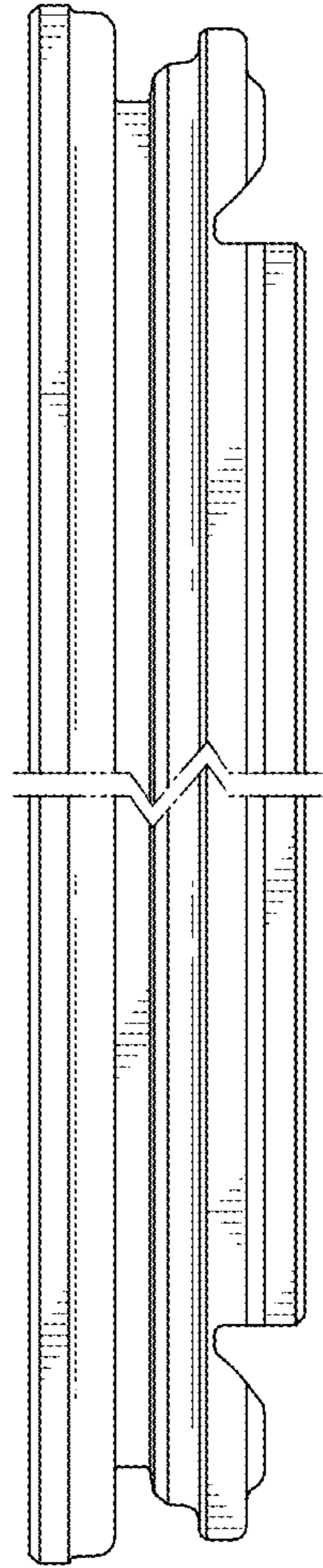

FIG. 5

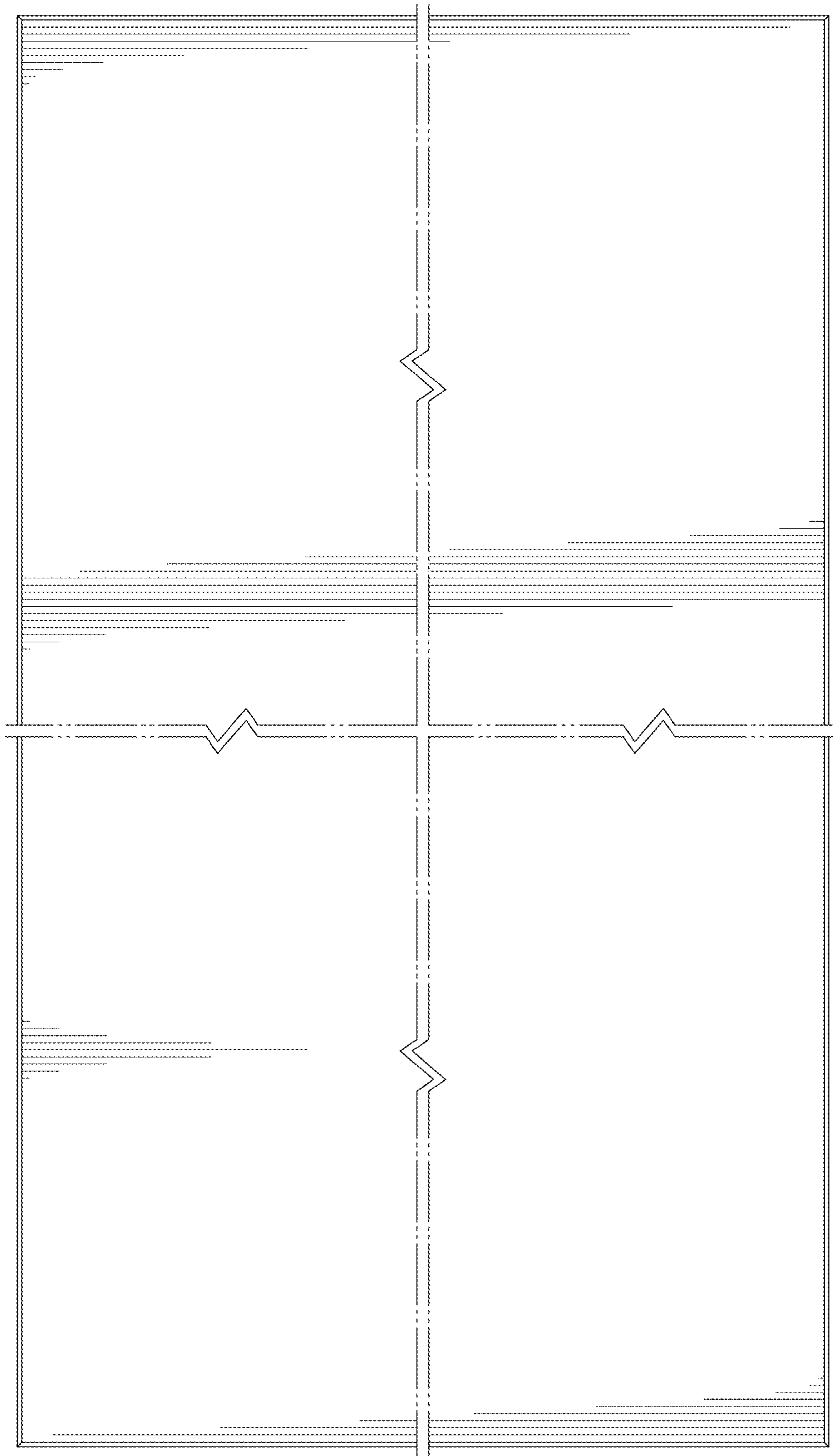

FIG. 6



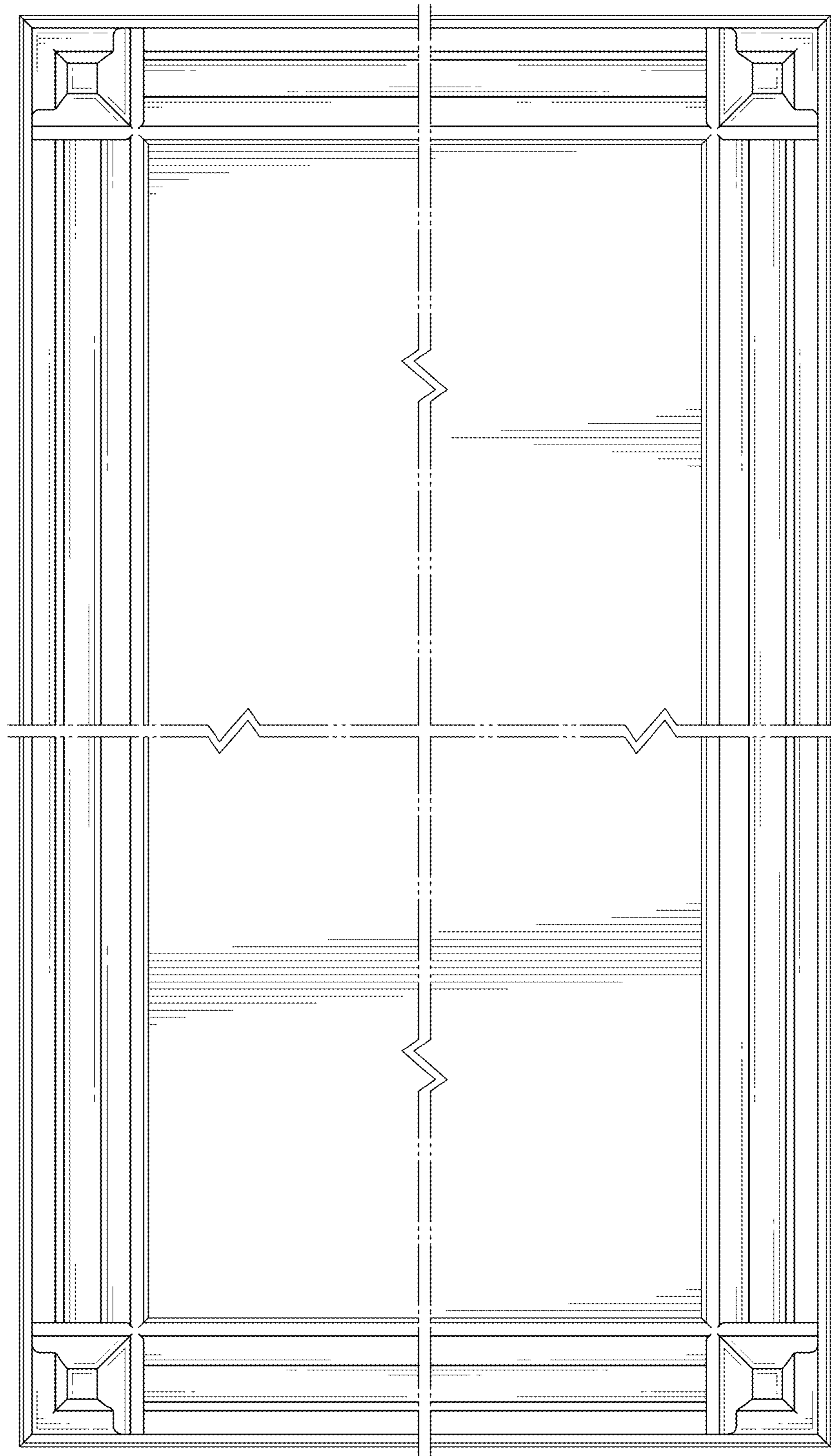

FIG. 7

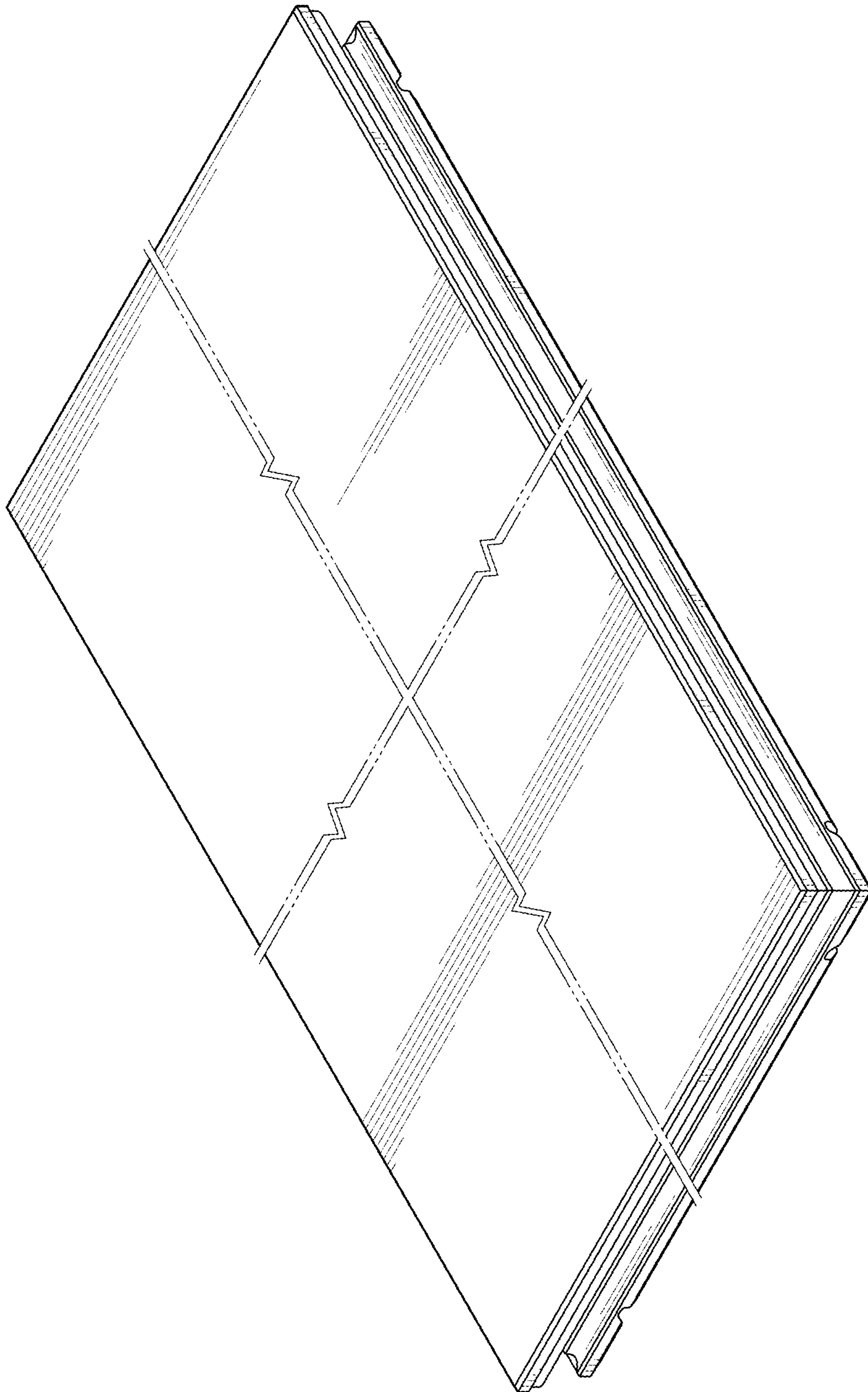

FIG. 8

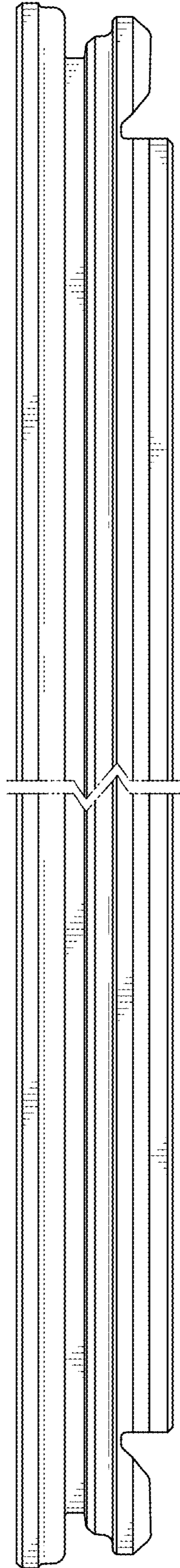

FIG. 9

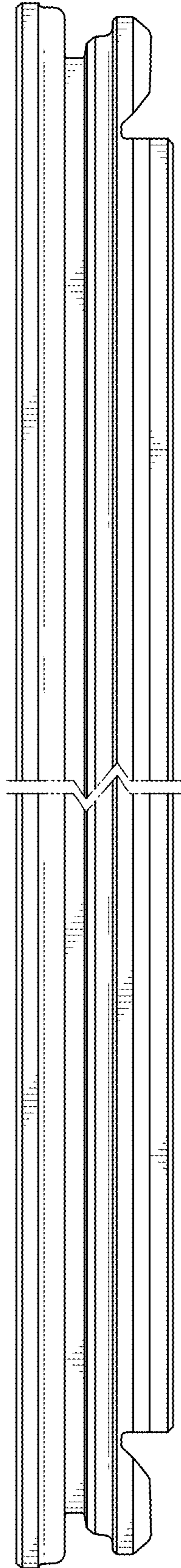

FIG. 10

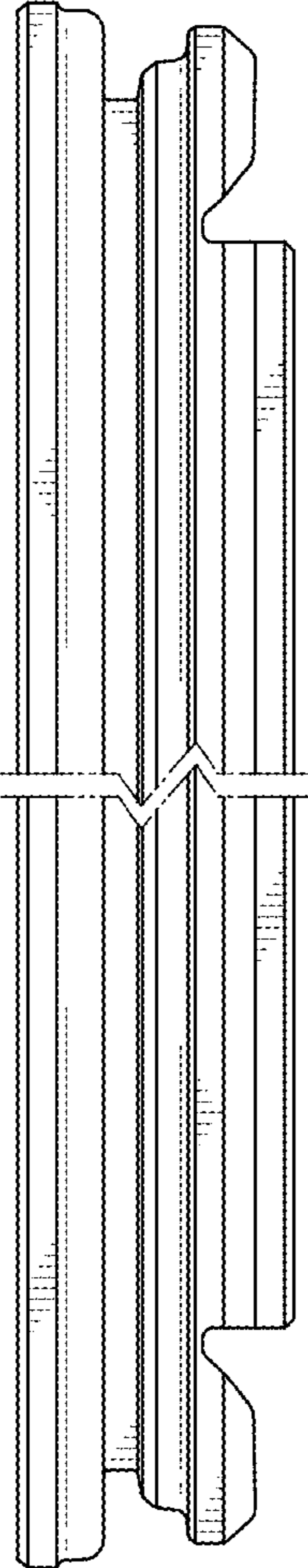

FIG. 11

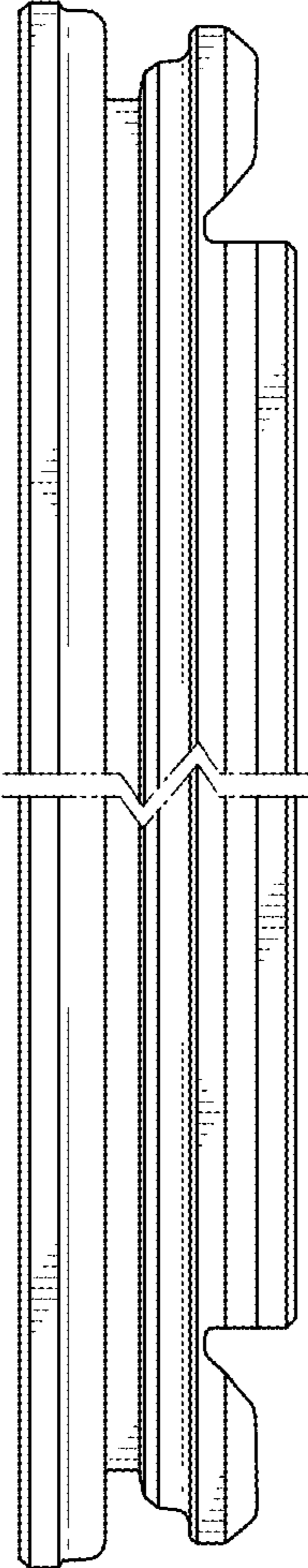

FIG. 12

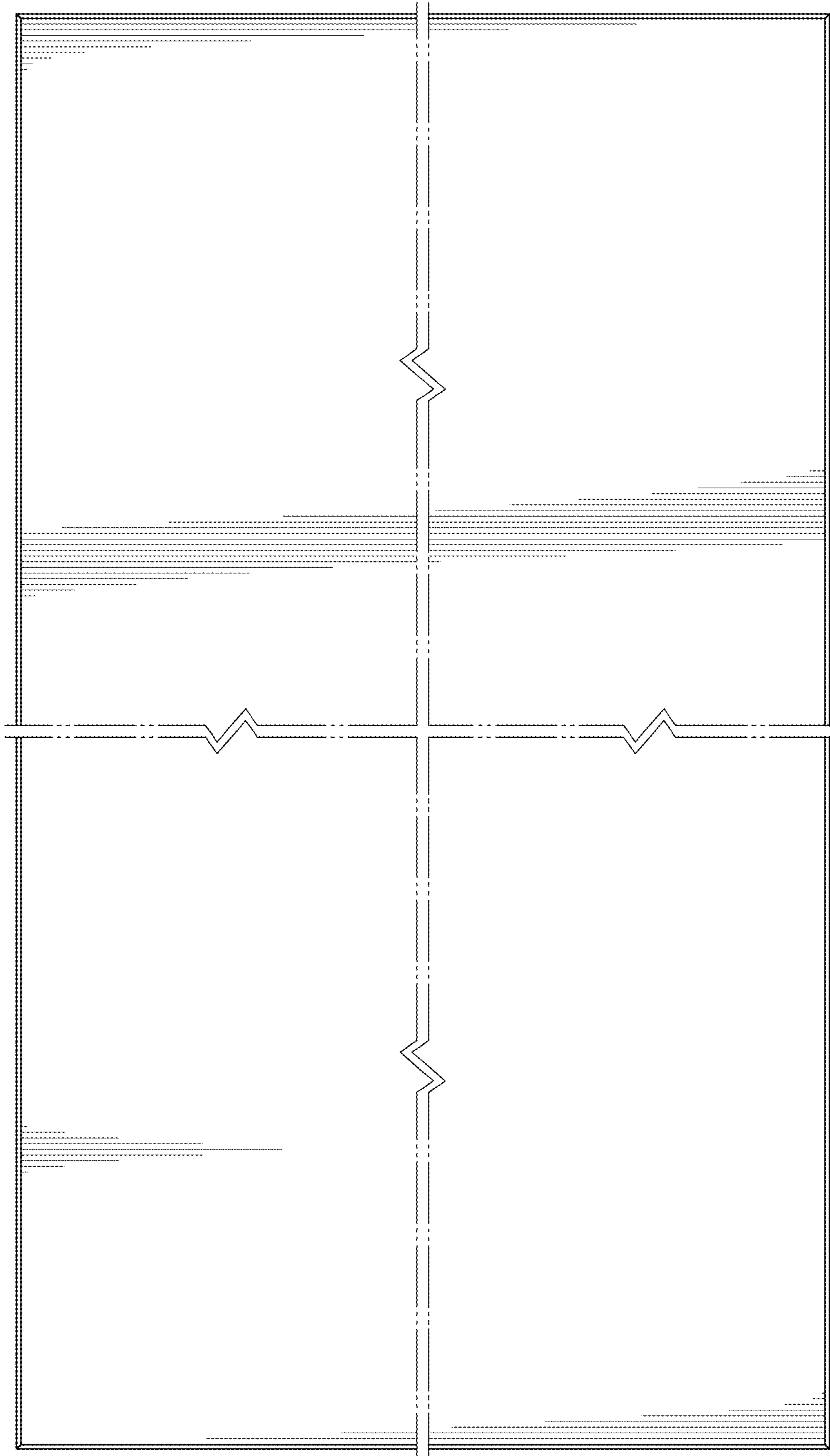

FIG. 13

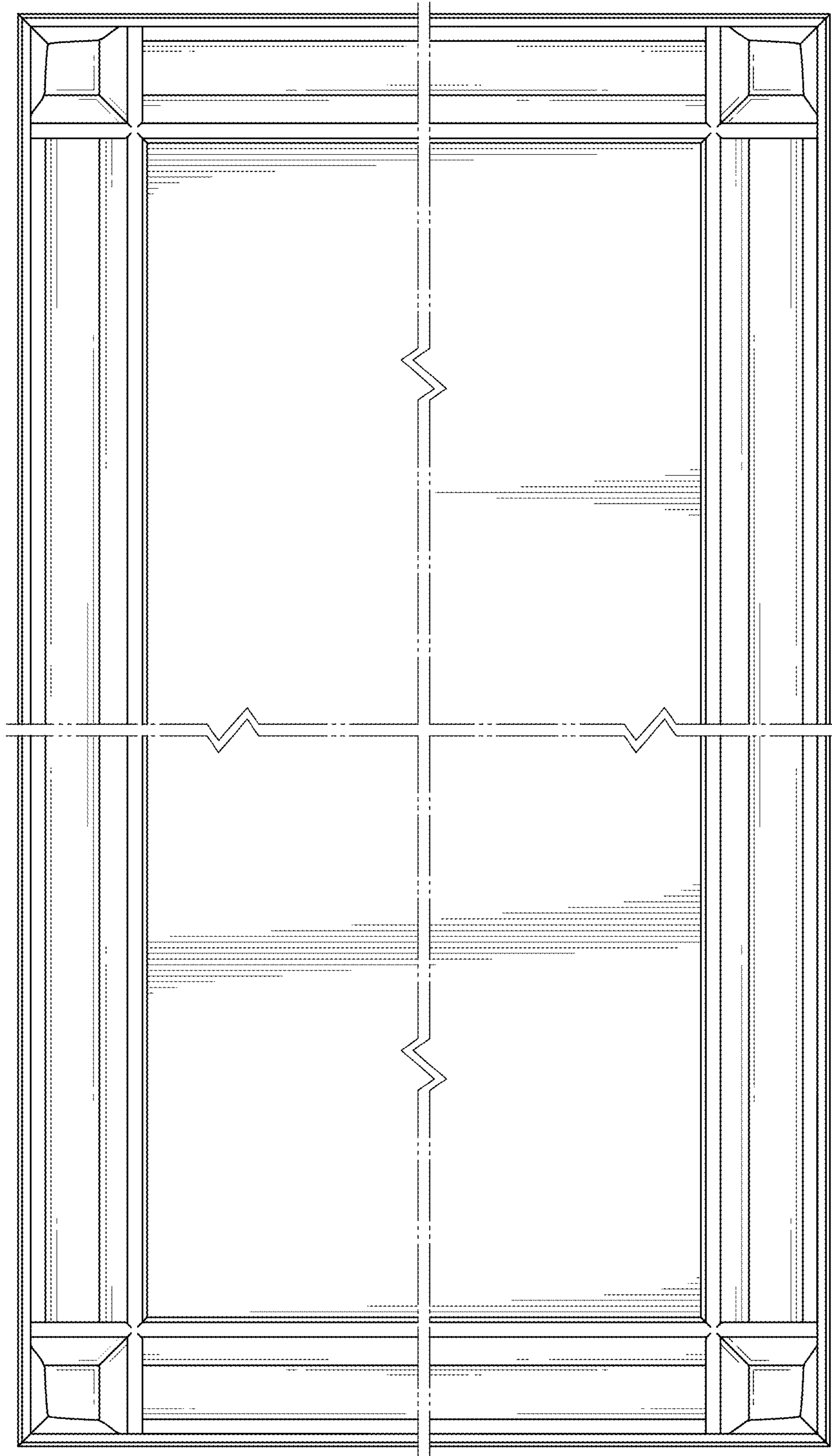

FIG. 14



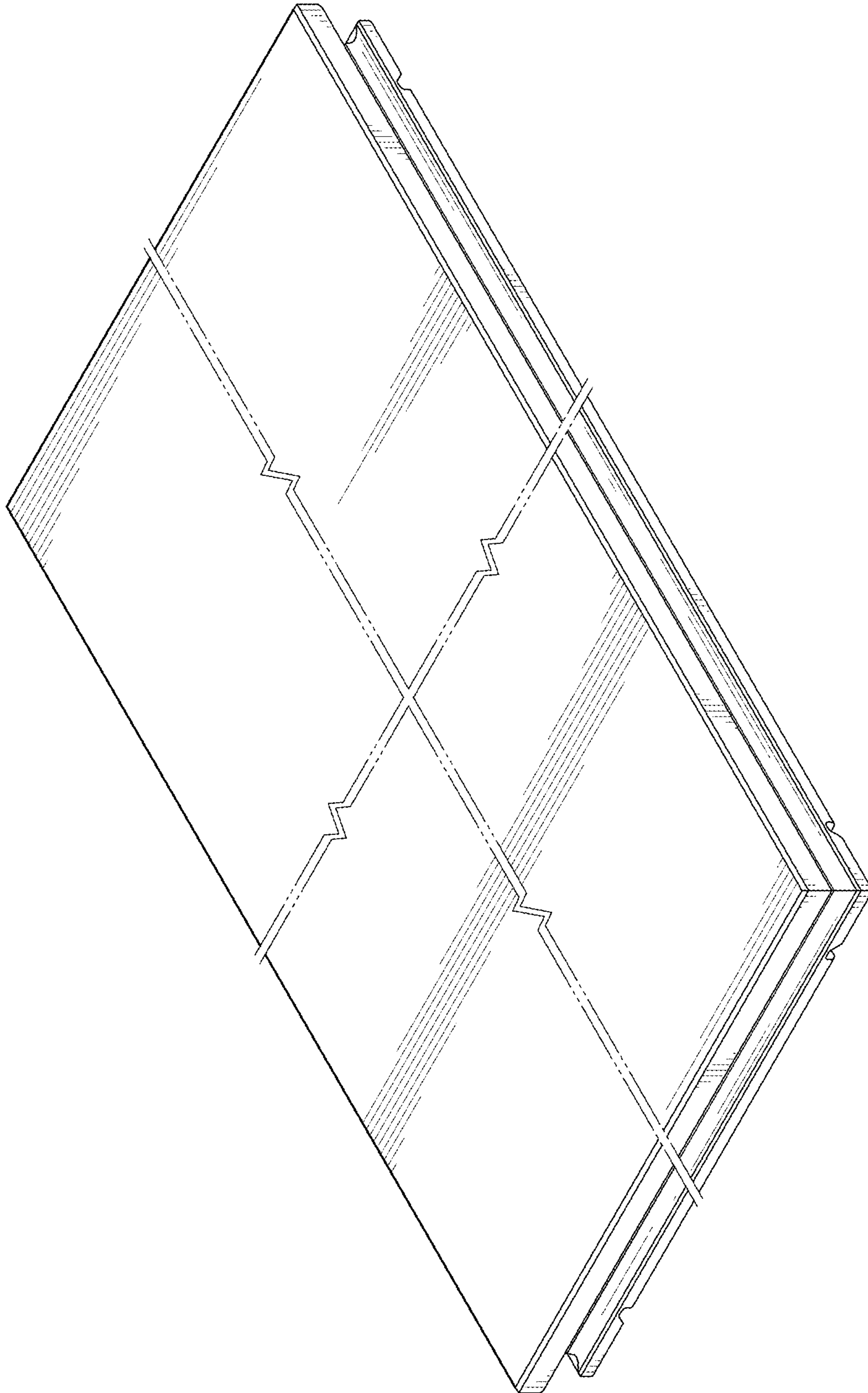

FIG. 15

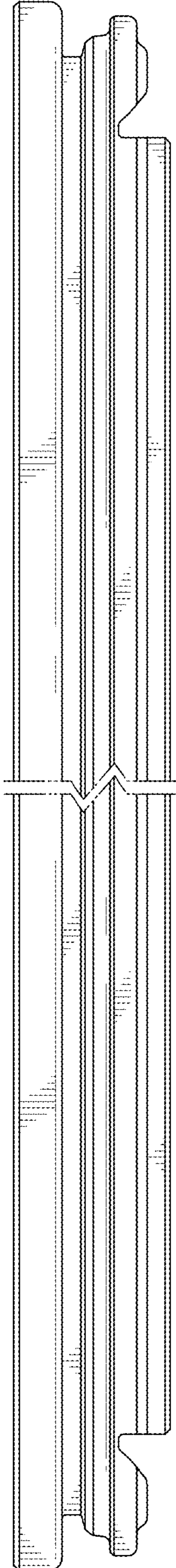

FIG. 16

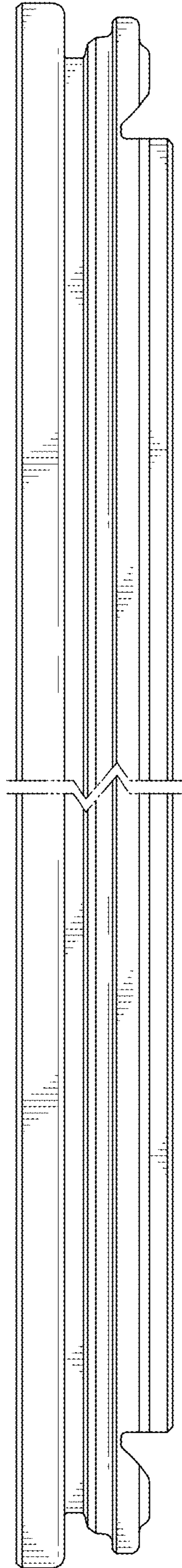

FIG. 17

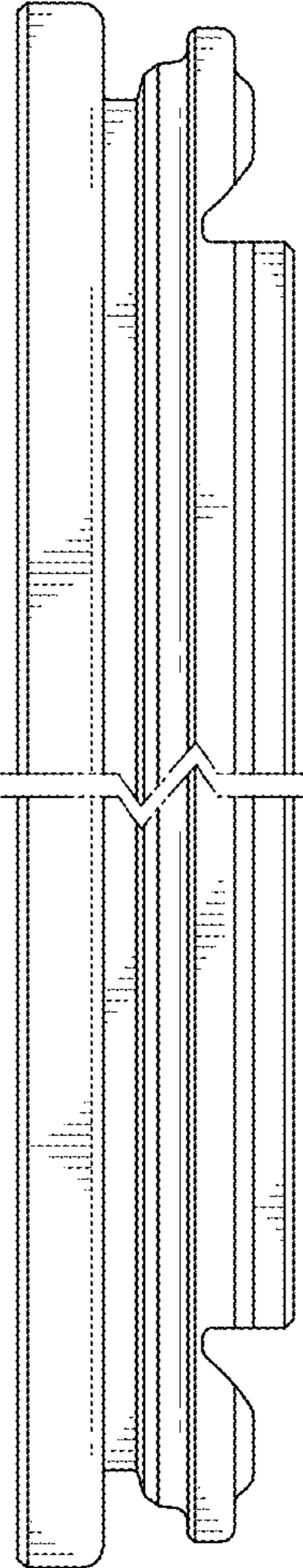

FIG. 18

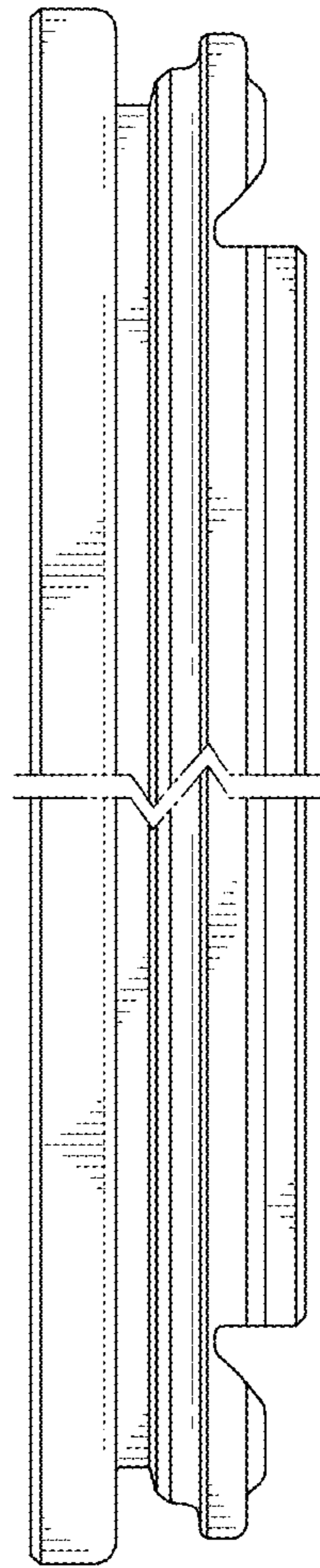

FIG. 19

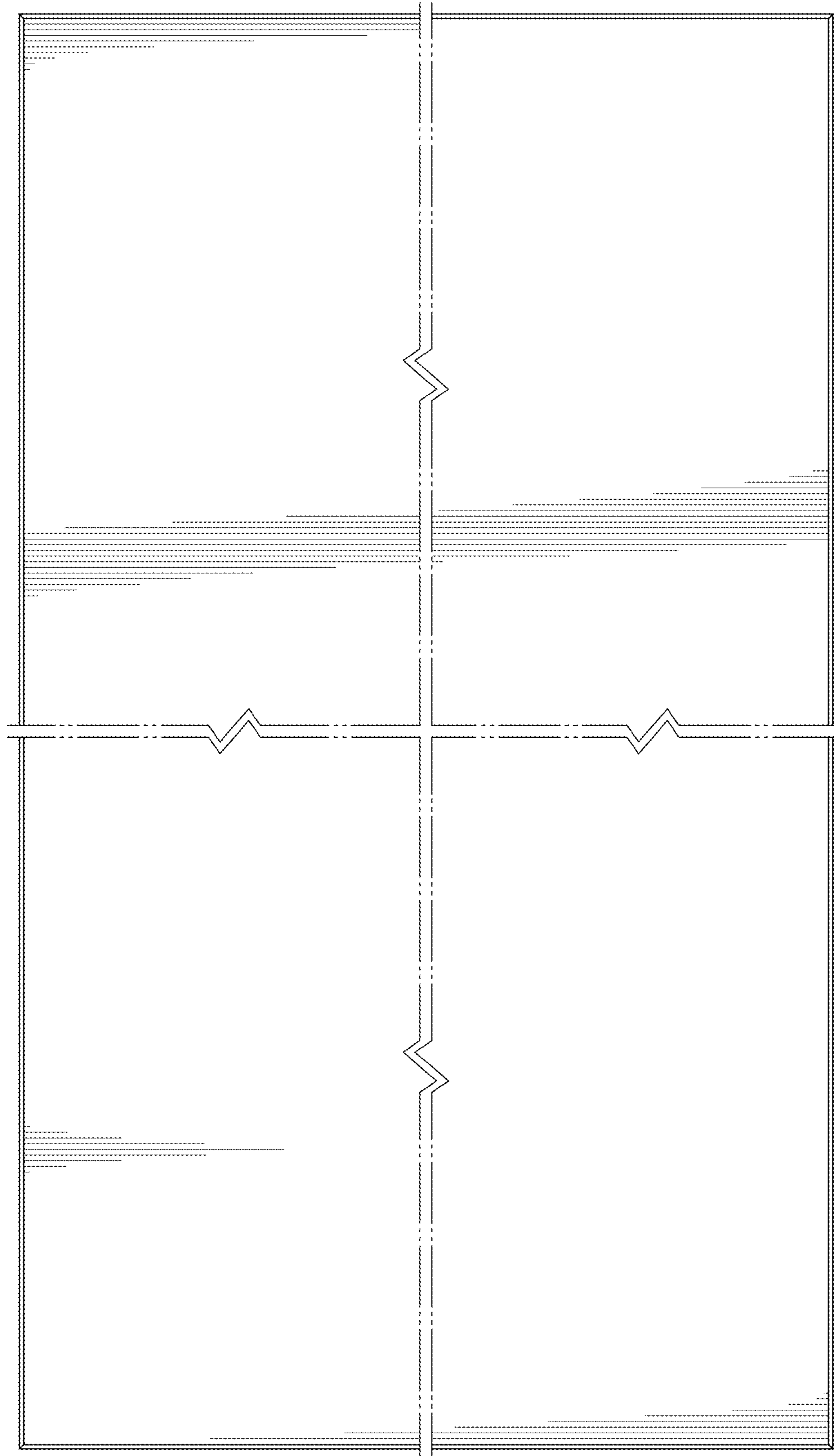

FIG. 20

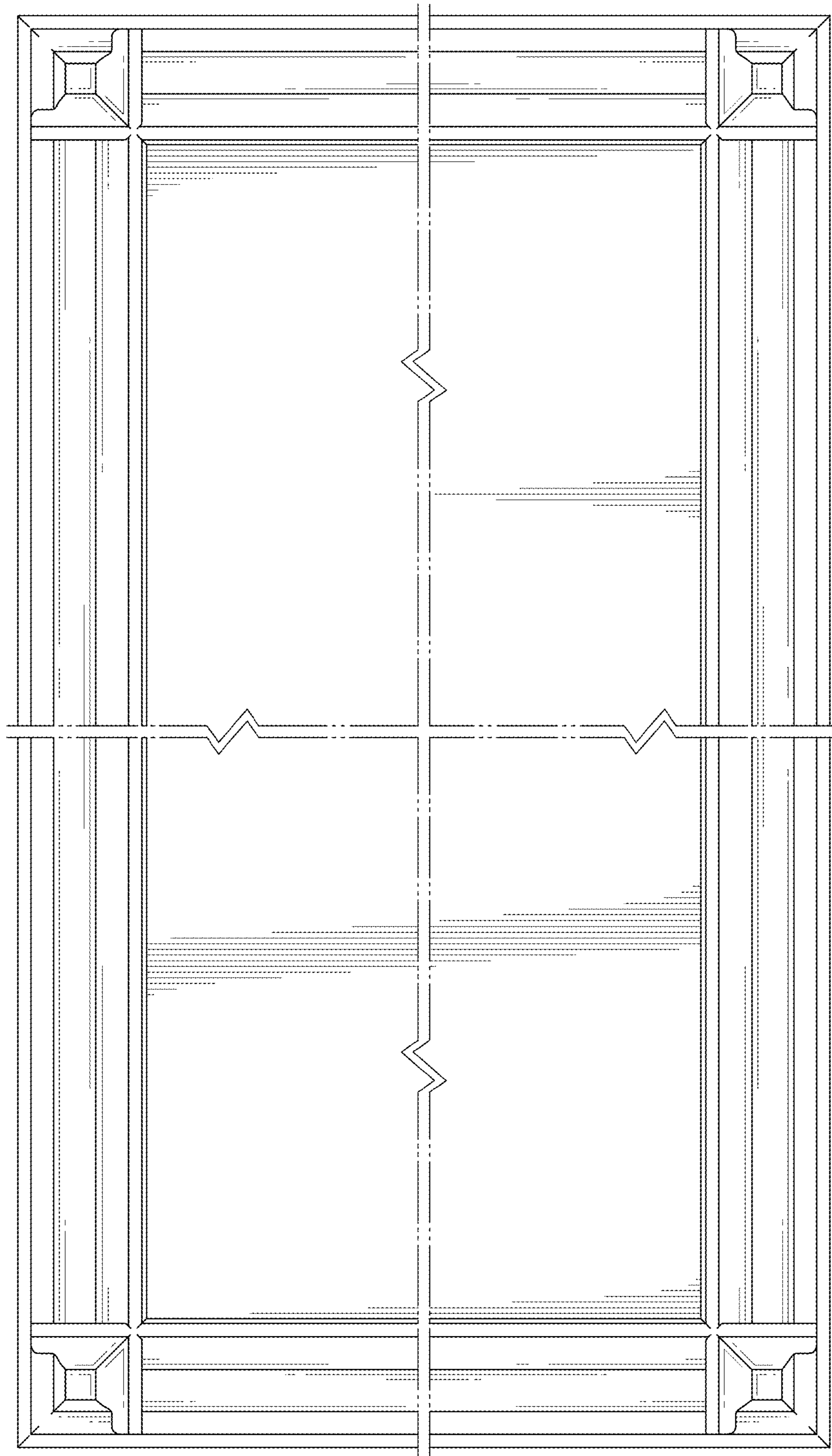

FIG. 21

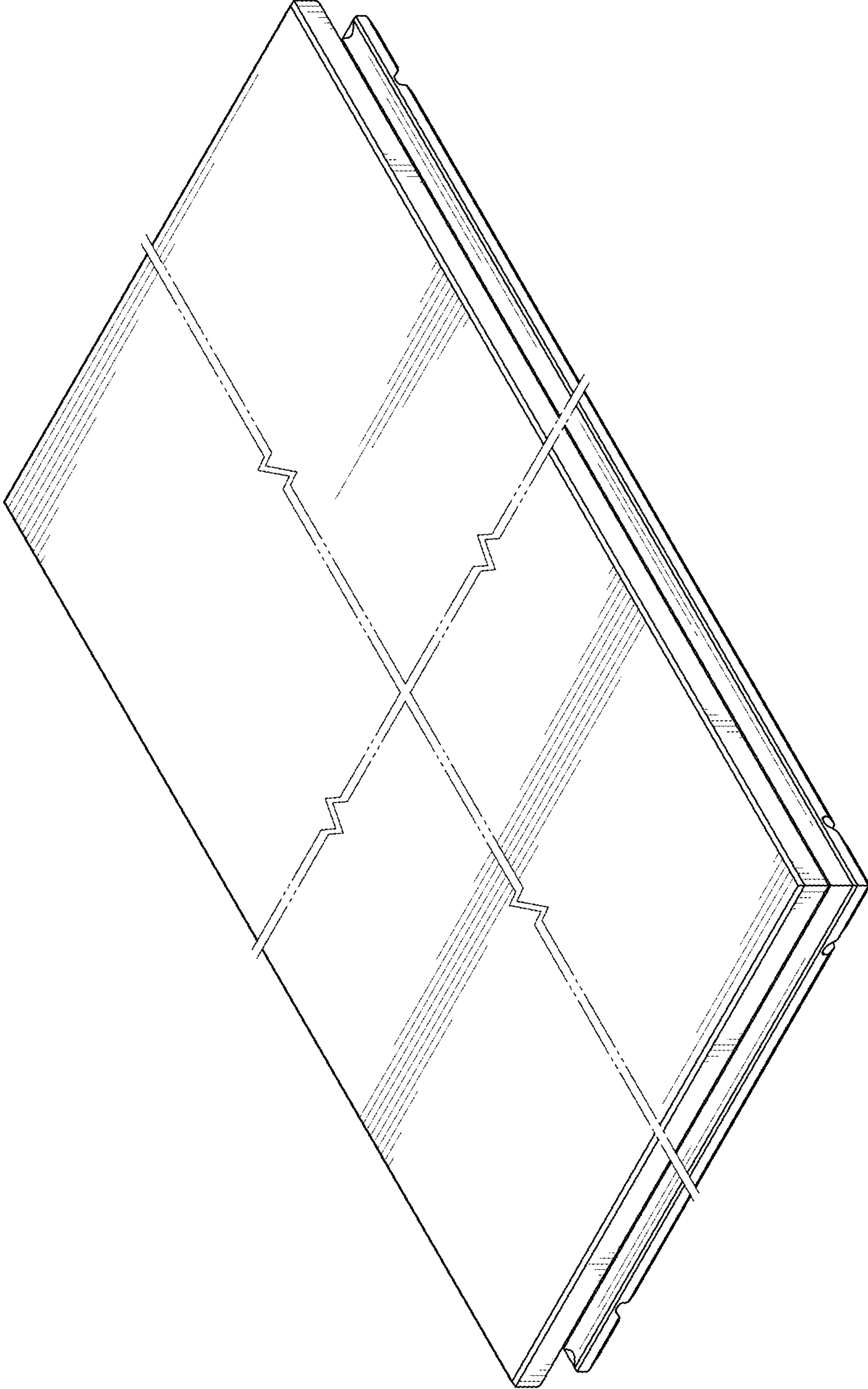

FIG. 22



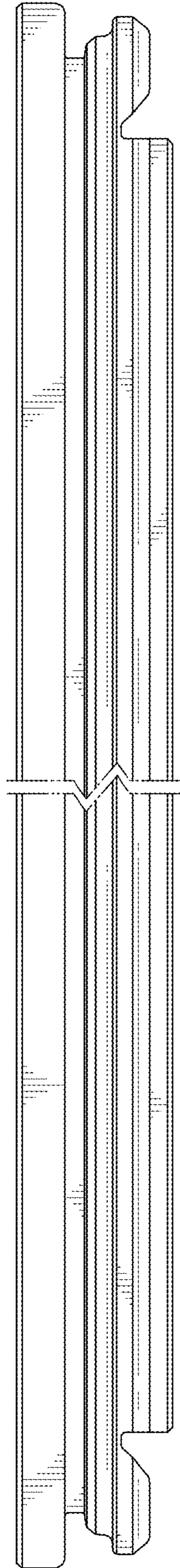

FIG. 23

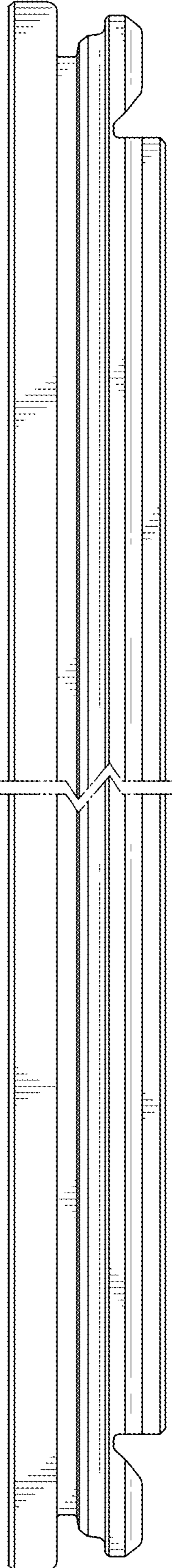

FIG. 24

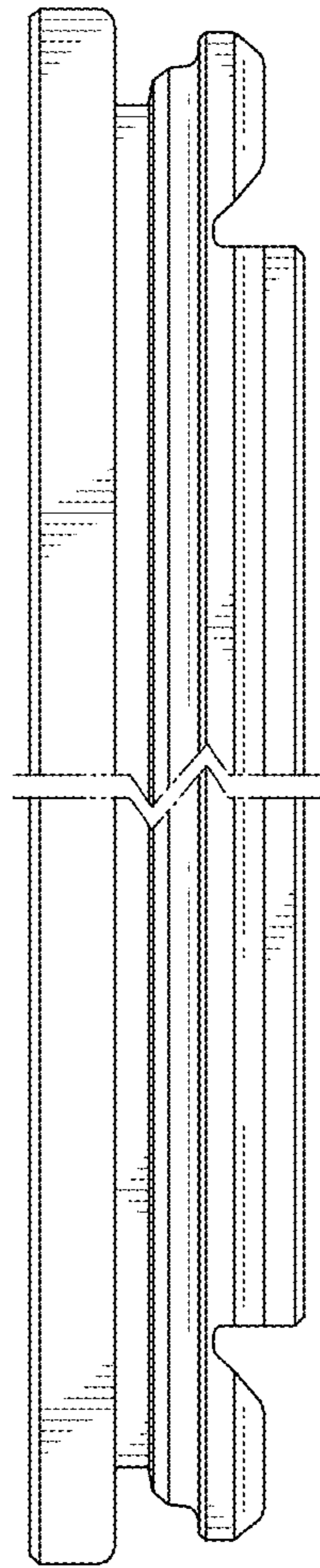

FIG. 25

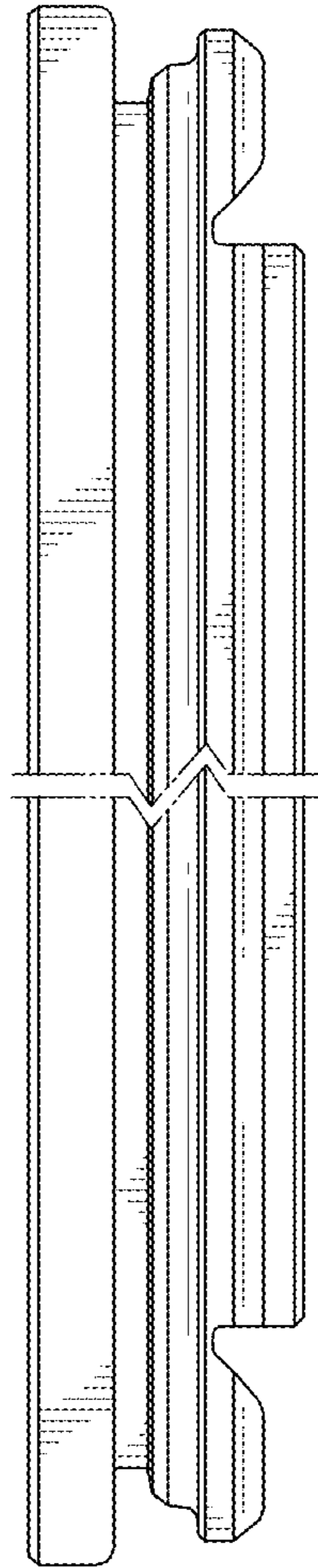

FIG. 26

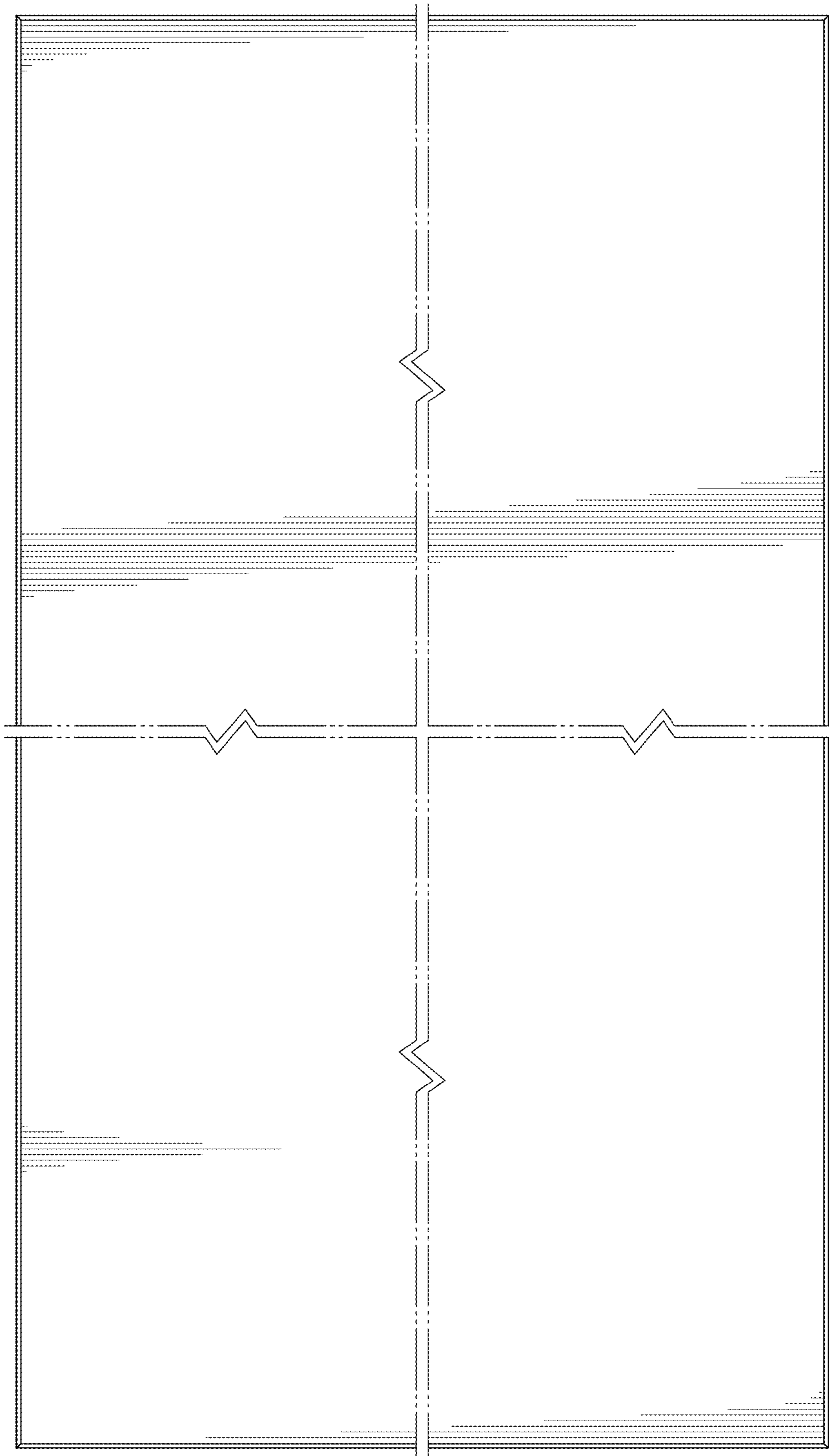

FIG. 27

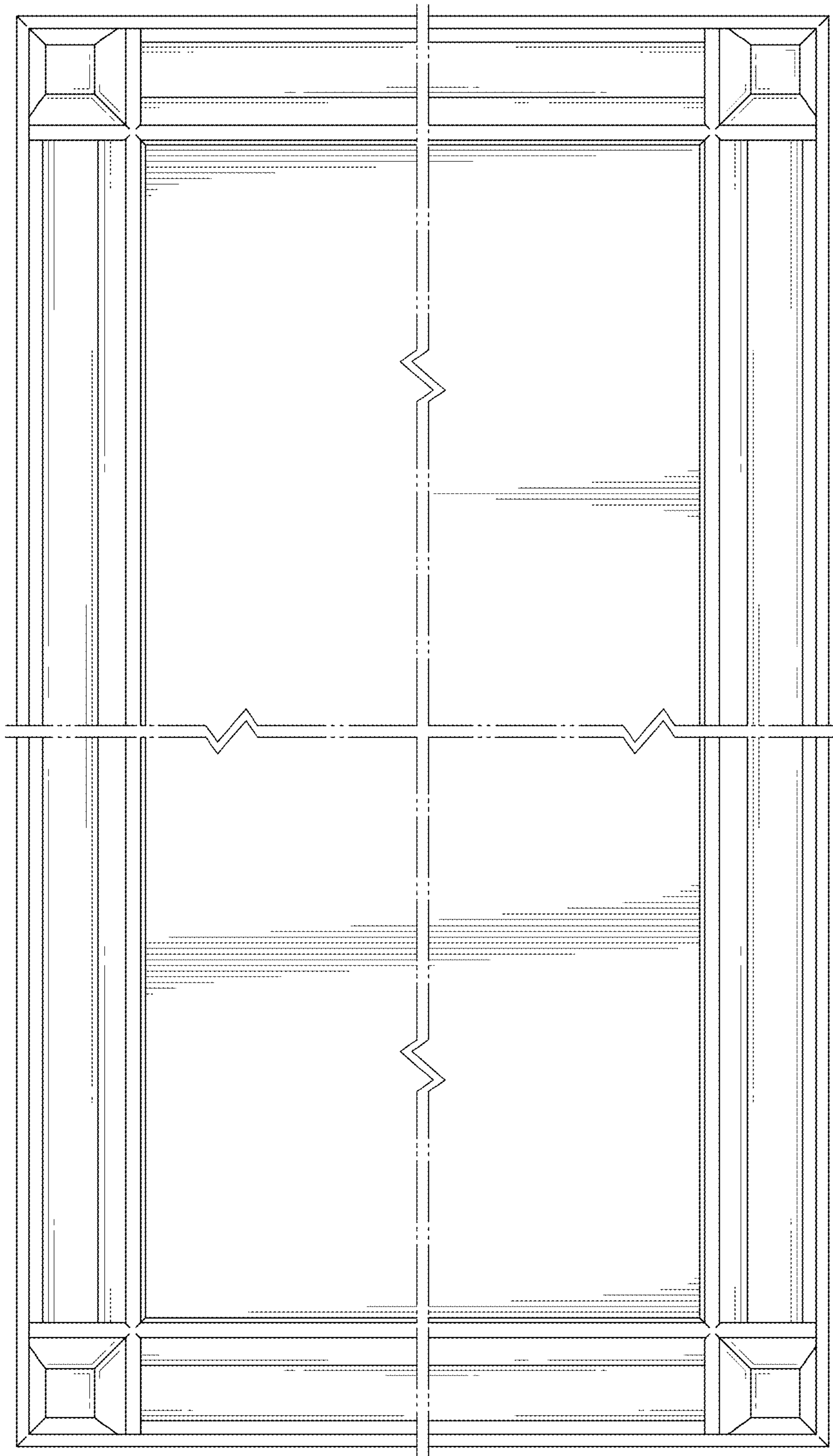

FIG. 28