



US00D876641S

(12) **United States Design Patent** (10) **Patent No.:** **US D876,641 S**
Eaves, III et al. (45) **Date of Patent:** **** Feb. 25, 2020**

(54) **MEDICAL ARTICLE FOR TREATING A WOUND AND/OR SCAR TISSUE**

(71) Applicant: **EMRGE, LLC**, Atlanta, GA (US)

(72) Inventors: **Felmont F. Eaves, III**, Atlanta, GA (US); **David O. Kazmer**, Georgetown, MA (US); **Gary W. Knight**, Lebanon, OH (US); **Timothy G. Dietz**, Reading, MA (US); **William Eugene Clem**, Bozeman, MT (US)

(73) Assignee: **EMRGE, LLC.**, Atlanta, GA (US)

(**) Term: **15 Years**

(21) Appl. No.: **29/622,936**

(22) Filed: **Oct. 20, 2017**

(51) **LOC (12) Cl.** **24-04**

(52) **U.S. Cl.**
USPC **D24/189**

(58) **Field of Classification Search**
USPC D24/188, 189, 191, 192, 206; D28/27, D28/39, 42, 75
CPC A61B 17/085; A61B 17/00491; A61B 17/064; A61B 17/10; A61B 2017/00862; A61B 2017/00951
See application file for complete search history.

(56) **References Cited**

U.S. PATENT DOCUMENTS

2,254,620	A	9/1941	Miller
2,371,978	A	3/1945	Perham
3,068,870	A	3/1960	Levin
3,487,836	A	1/1970	Niebel et al.
4,539,990	A	9/1985	Stivala

(Continued)

FOREIGN PATENT DOCUMENTS

AU	2012236205	B2	8/2016
AU	2016262734		12/2016

(Continued)

OTHER PUBLICATIONS

Amazon. Elastic Bandage Wrap Compression Tape—Review by Maria A. Dec. 18, 2017. <URL:https://www.amazon.com/Elastic-Bandage-Wrap-Compression-Tape/dp/B06XQ8B8Y8?th=1>. (Year: 2017).*

(Continued)

Primary Examiner — Darcey E Gottschalk
(74) *Attorney, Agent, or Firm* — Additon, Higgins & Pendleton, P.A.

(57) **CLAIM**

The ornamental design for a medical article for treating a wound and/or scar tissue, as shown and described.

DESCRIPTION

FIG. 1 is a top perspective view of a medical article for treating a wound and/or scar tissue, in accordance with the present invention;
FIG. 2 is a top plan view of the medical article of FIG. 1;
FIG. 3 is a bottom plan view of the medical article of FIG. 1;
FIG. 4 is a front elevation view of the medical article of FIG. 1;
FIG. 5 is a rear elevation view of the medical article of FIG. 1;
FIG. 6 is a right elevation view of the medical article of FIG. 1;
FIG. 7 is a left elevation view of the medical article of FIG. 1; and,
FIG. 8 is an exploded bottom perspective view of the medical article of FIG. 1.
In the drawings, the broken lines show portions of a medical article for treating a wound and/or scar tissue that form no part of the claimed design.

1 Claim, 6 Drawing Sheets

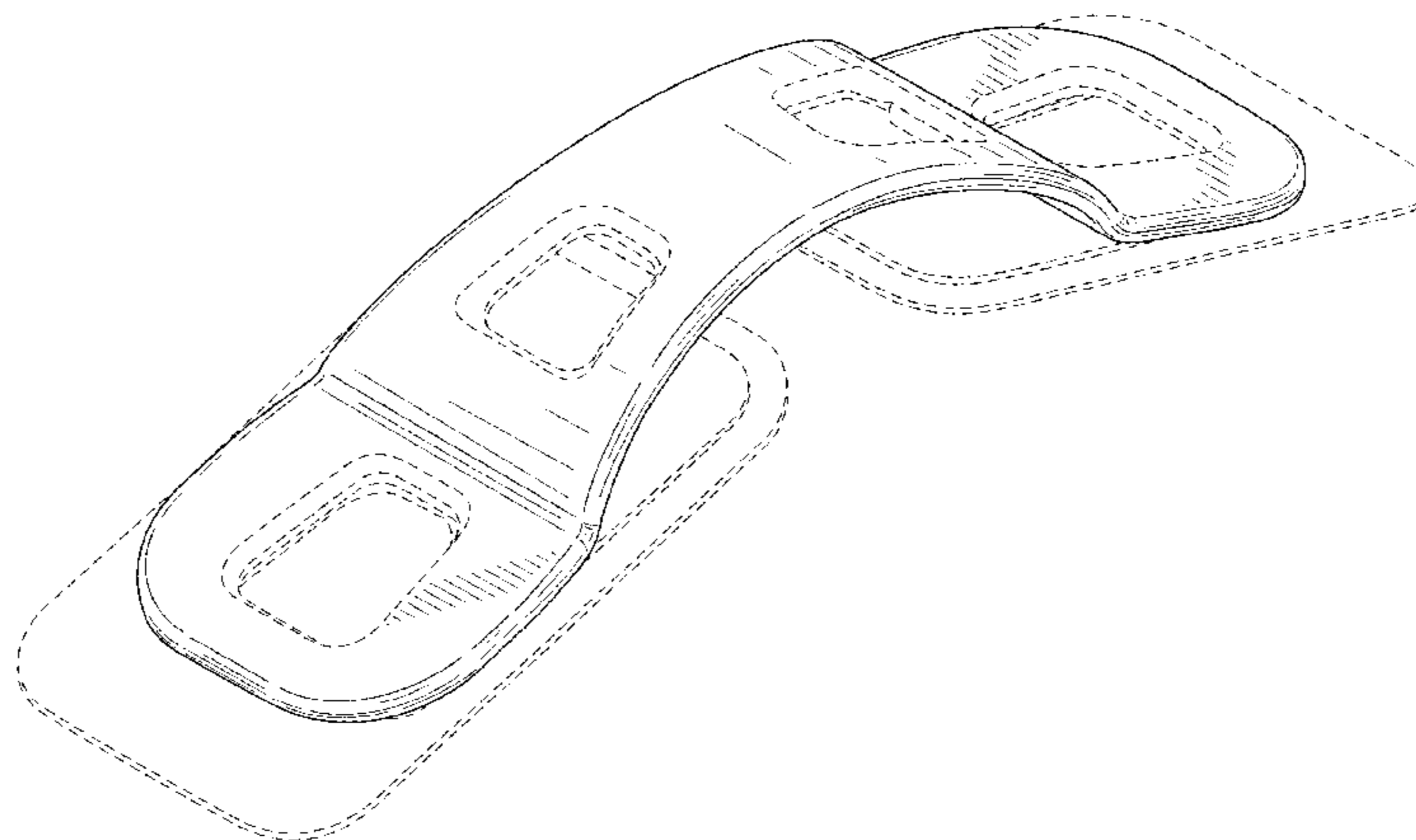

(56)

References Cited

U.S. PATENT DOCUMENTS

4,702,251	A	10/1987	Sheehan	
4,815,468	A	3/1989	Annand	
5,230,701	A	7/1993	Meyer et al.	
D359,144	S *	6/1995	Healzer	D28/42
6,176,868	B1	1/2001	Detour	
7,332,641	B2	2/2008	Lebner et al.	
7,683,234	B2	3/2010	Gurtner et al.	
8,157,839	B2	4/2012	Riskin et al.	
8,183,428	B2	5/2012	Gurtner et al.	
8,246,590	B2	8/2012	Hu et al.	
D667,167	S *	9/2012	Stewart	D28/42
D671,265	S *	11/2012	Stewart	D28/42
D674,544	S *	1/2013	Stewart	D28/42
8,435,221	B2	5/2013	Hu et al.	
D683,860	S *	6/2013	Quimby	D24/191
D690,020	S *	9/2013	Quimby	D24/191
8,562,576	B2	10/2013	Hu et al.	
8,834,434	B2	9/2014	Hu et al.	
9,028,529	B2	5/2015	Riskin et al.	
9,301,760	B2	4/2016	Fox	
9,421,133	B2	8/2016	Hu et al.	
D780,317	S *	2/2017	Vandervoort	D24/189
9,603,596	B2	3/2017	Riskin et al.	
D790,072	S *	6/2017	Hiebert	D24/191
D811,609	S *	2/2018	Huff	D24/189
D831,220	S *	10/2018	Chase	D24/189
2002/0111641	A1	8/2002	Peterson et al.	
2005/0080453	A1	4/2005	Lebner	
2006/0200198	A1	9/2006	Riskin et al.	
2009/0240186	A1	9/2009	Frang	
2009/0259203	A1	10/2009	Hu et al.	
2010/0081983	A1	4/2010	Zocher	
2010/0228287	A1	9/2010	Jeekel	
2010/0262126	A1	10/2010	Hu et al.	
2011/0004173	A1	1/2011	Hu et al.	
2011/0040325	A1	2/2011	Moehrle	
2011/0105963	A1	5/2011	Hu et al.	
2012/0172779	A1	7/2012	Spinelli et al.	
2012/0221044	A1	8/2012	Archiblad et al.	
2013/0178897	A1	7/2013	Wu et al.	
2014/0107597	A1	4/2014	Hu et al.	
2014/0128819	A1	5/2014	Eaves	
2014/0227483	A1	8/2014	Eaves	
2014/0336701	A1	11/2014	McLorg	
2015/0005722	A1	1/2015	Hu et al.	
2015/0305739	A1	10/2015	Rolandi et al.	
2016/0324693	A1	11/2016	Hu et al.	
2018/0125492	A1	5/2018	Eaves	

FOREIGN PATENT DOCUMENTS

CA	2830918	A1	10/2012
CN	1889903	A	1/2007
CN	101606856	A	12/2009
CN	103533900	B	12/2016
EP	2691029	A2	2/2014
FR	419096		10/1910

FR	794710		2/1936
JP	2011-500170	A	1/2011
JP	2014-516288		7/2014
KR	10-2009-0066415	A	6/2009
KR	10-2014-0020993		2/2014
TW	M340039	U	9/2008
WO	2009049232	A1	4/2009
WO	2011019859	A2	2/2011
WO	2013188884	A1	6/2012
WO	2012/135735		10/2012
WO	2013/059600		4/2013
WO	2018/075879		4/2018

OTHER PUBLICATIONS

Japanese Notice of Reasons for Rejection in related JP Application No. 2014-502866, dated Oct. 3, 2016; 9 pages.

Commonly owned Design U.S. Appl. No. 29/622,941, filed Oct. 20, 2017, pp. 1-57.

Commonly owned Design U.S. Appl. No. 29/622,936, filed Oct. 20, 2017, pp. 1-56.

Written Opinion in commonly owned PCT Application No. PCT/2018/057569, dated Apr. 26, 2018, pp. 1-5.

Search Report in commonly owned PCT Application No. PCT/2018/057569, dated Feb. 2, 2018, pp. 1-6.

First Chinese Office Action in related CN Application No. 201611102500.1, dated Aug. 20, 2018, 21 pages (including English Translation).

Commonly owned U.S. Appl. No. 16/153,340, filed Oct. 5, 2018, pp. 1-111.

SutureSafe Inc., Product Brochure SutureSafe Support closed wounds and provide stability; 2 pages [Downloaded Jul. 25, 2017 from <http://dynamicissuesystems.com/wp-content/uploads/2015/09/SutureSafe-SS-lr2.pdf>].

Southmedic Inc., SutureSafe Instructions for Use, 2 pages [Downloaded Jul. 25, 2017 from http://dynamicissuesystems.com/wp-content/uploads/2015/09/IFU0251_E.pdf].

Examination Report No. 1 in related Australian Application No. 2016262734, dated Jan. 14, 2019, 3 pages [FR 419096; US 2010/0262126 & U.S. Pat. No. 4,702,251 previously cited].

Supplementary Partial European Search Report for EP Application No. 12762897, dated Dec. 23, 2014, 7 pages.

International Search Report and Written Opinion issued in PCT/US2012/031638 dated Nov. 29, 2012; 10 pages.

Extended Search Report for related EP Application 12762897.2, dated May 27, 2015, 11 pages.

Japanese Office Action for related JP Application No. 2014-502866, dated Dec. 10, 2015, Translation provided, 11 pages.

Australian Patent Examination Report No. 1 in related Australian Patent Application No. 201226205, dated Aug. 28, 2015, 5 pages.

Chinese First Office Action for related CN Application No. 201280017051.4, dated Jun. 1, 2015, Translation provided, 13 pages.

Chinese Second Office Action for related CN Application No. 201280017051.4, dated Dec. 31, 2015, Translation provided, 8 pages.

* cited by examiner

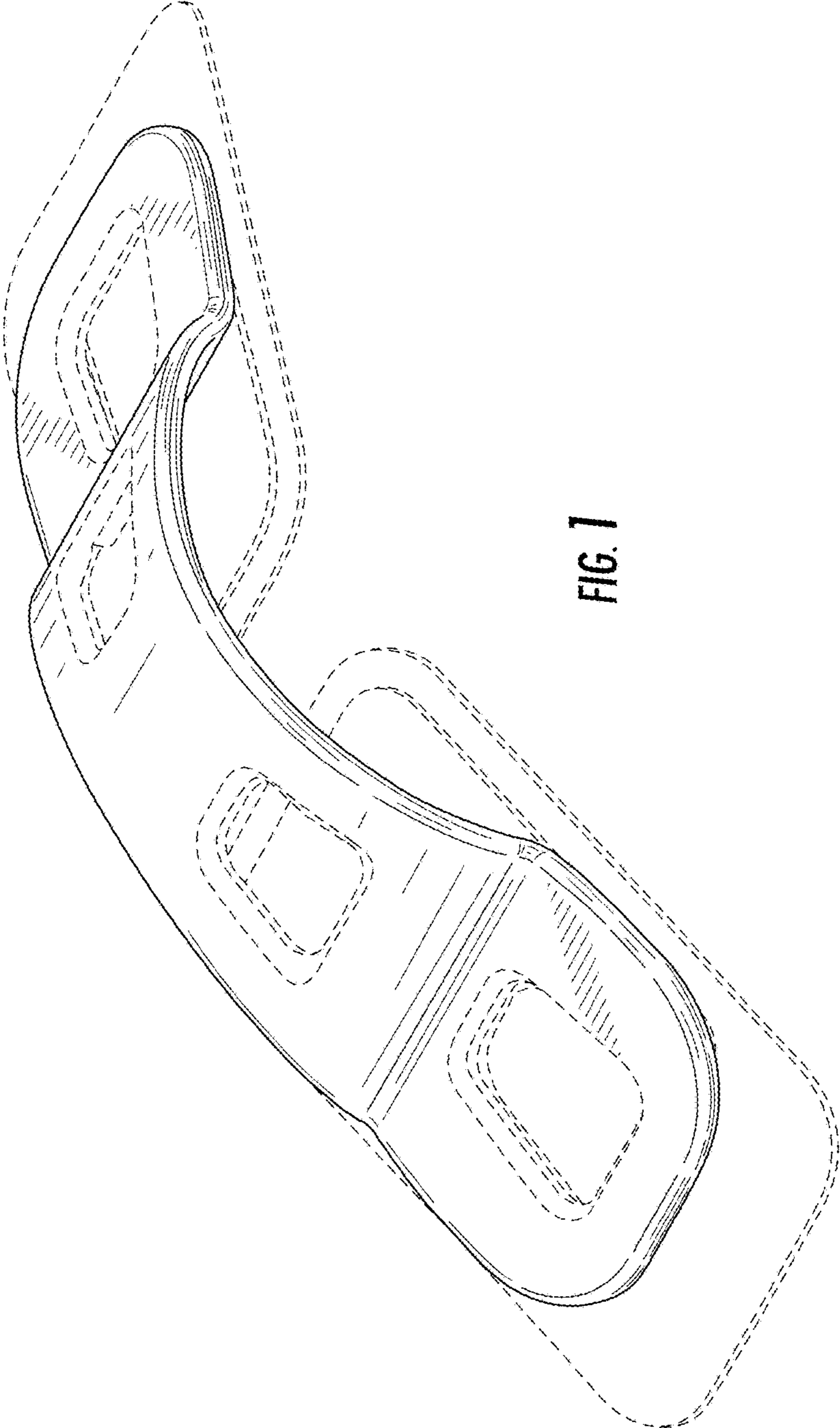

FIG. 1

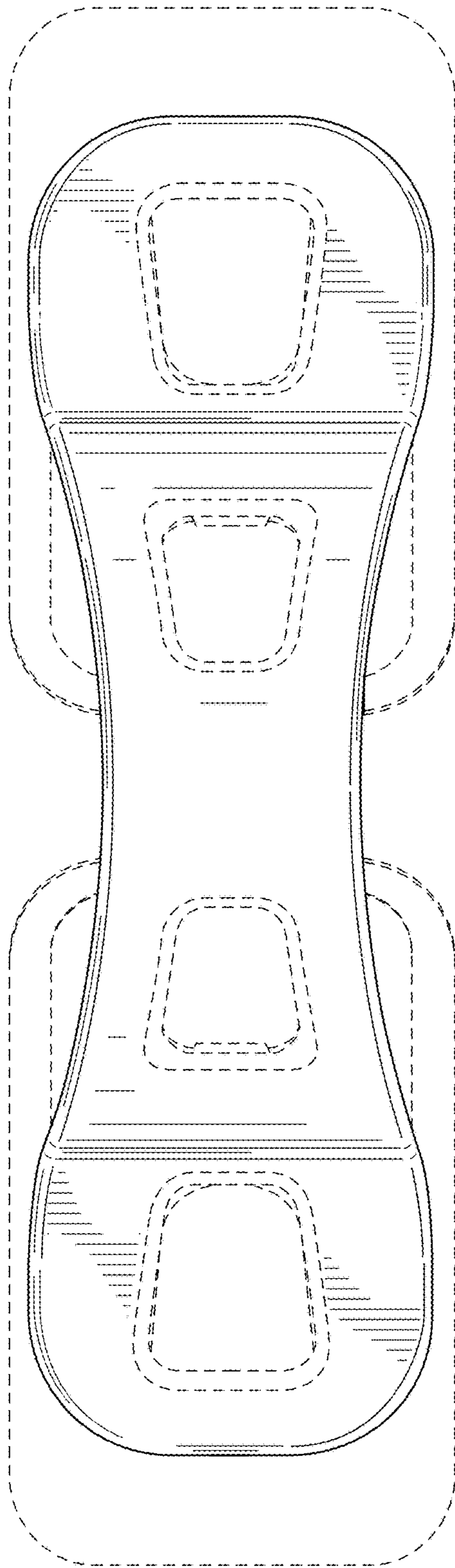

FIG. 2

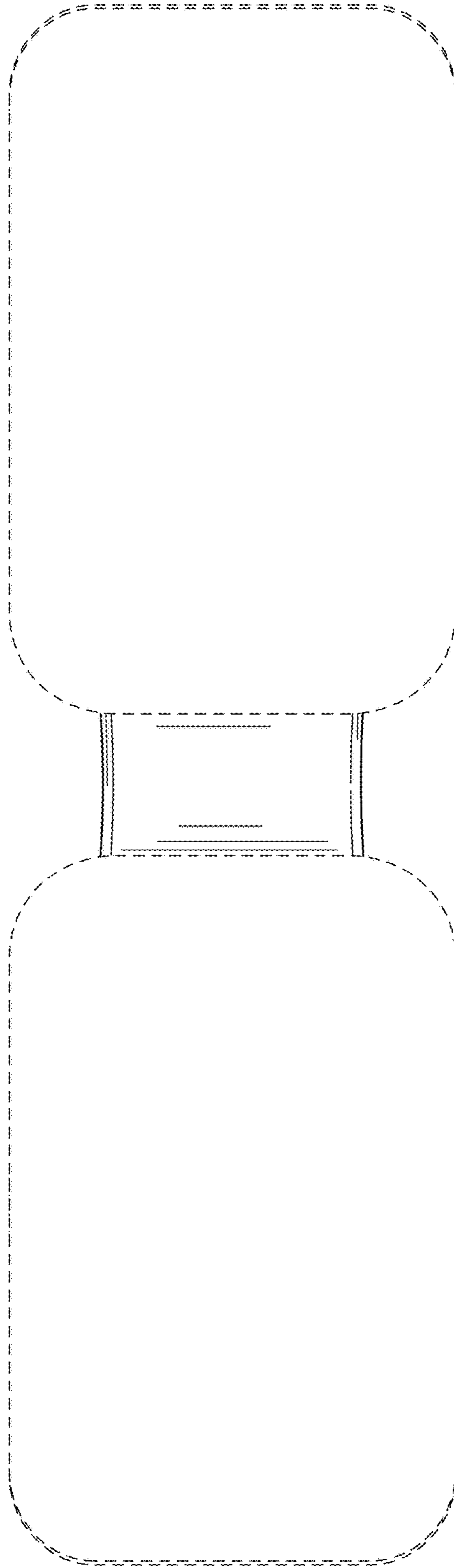
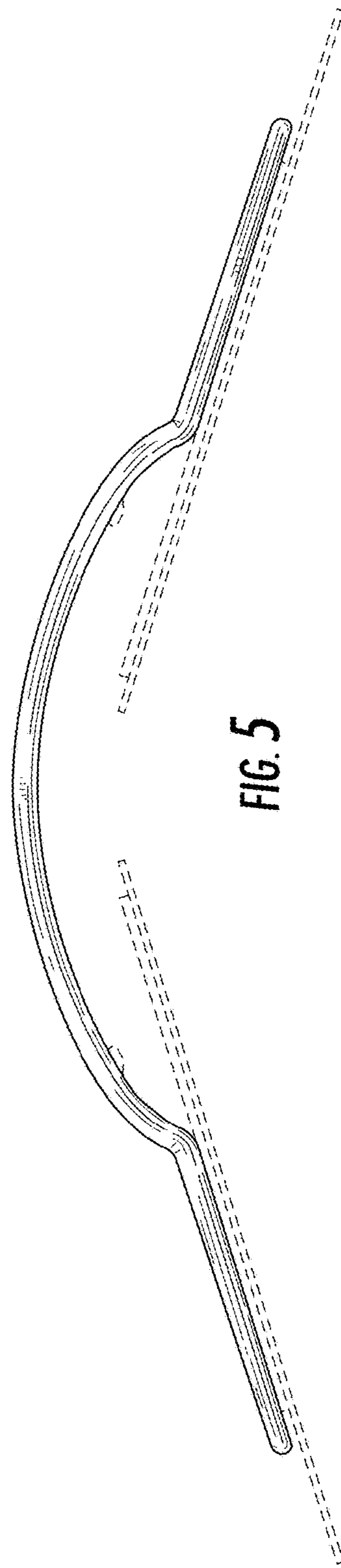
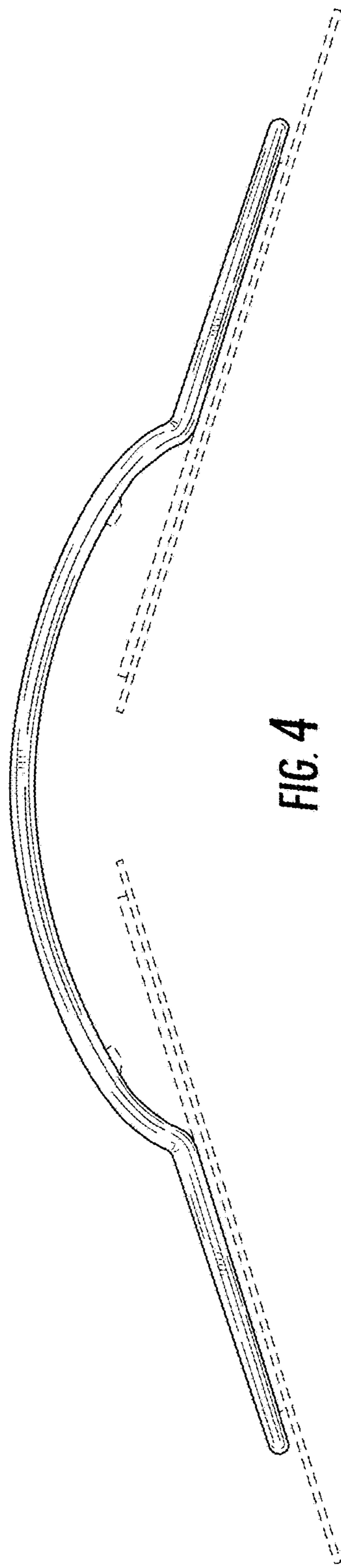

FIG. 3



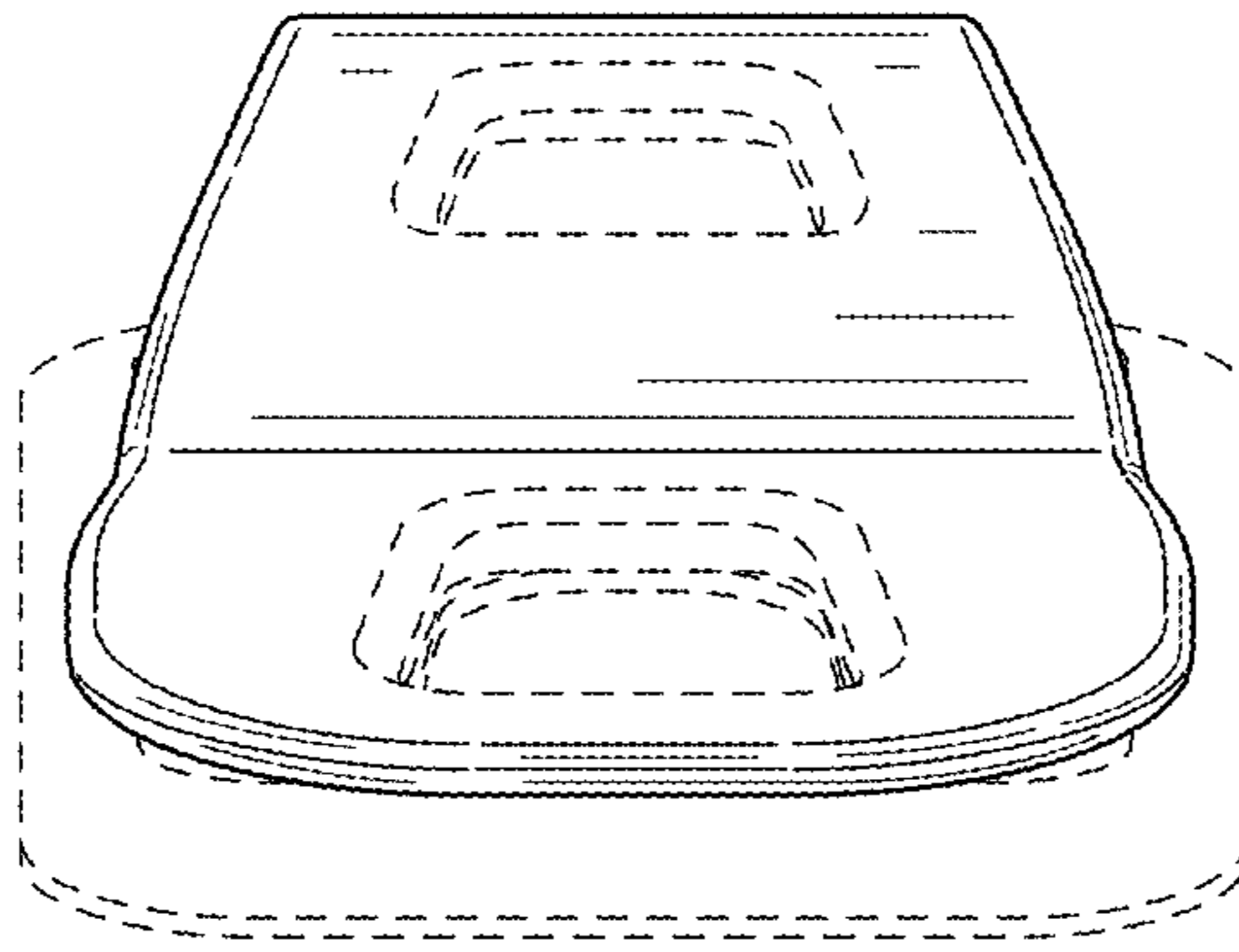

FIG. 6

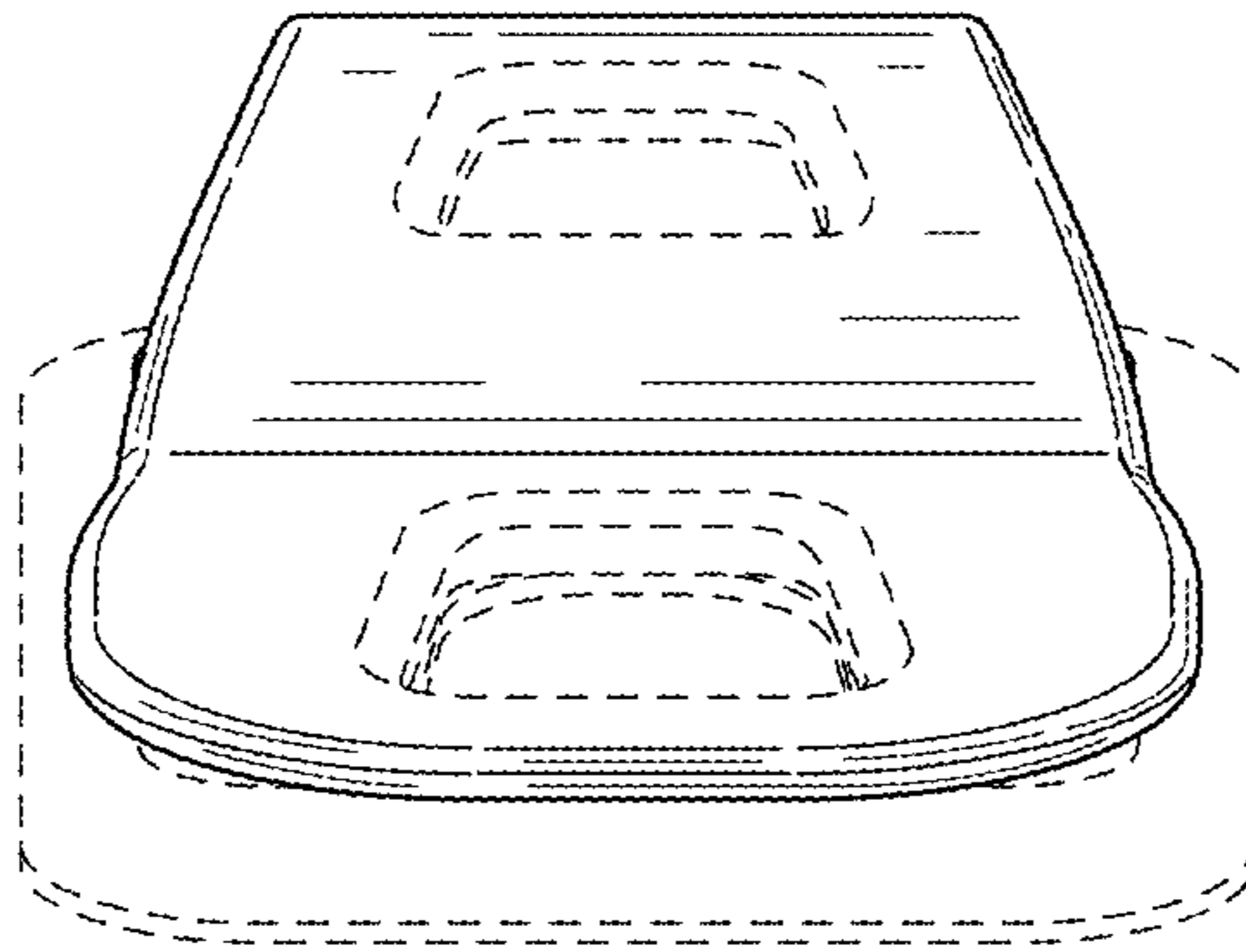

FIG. 7

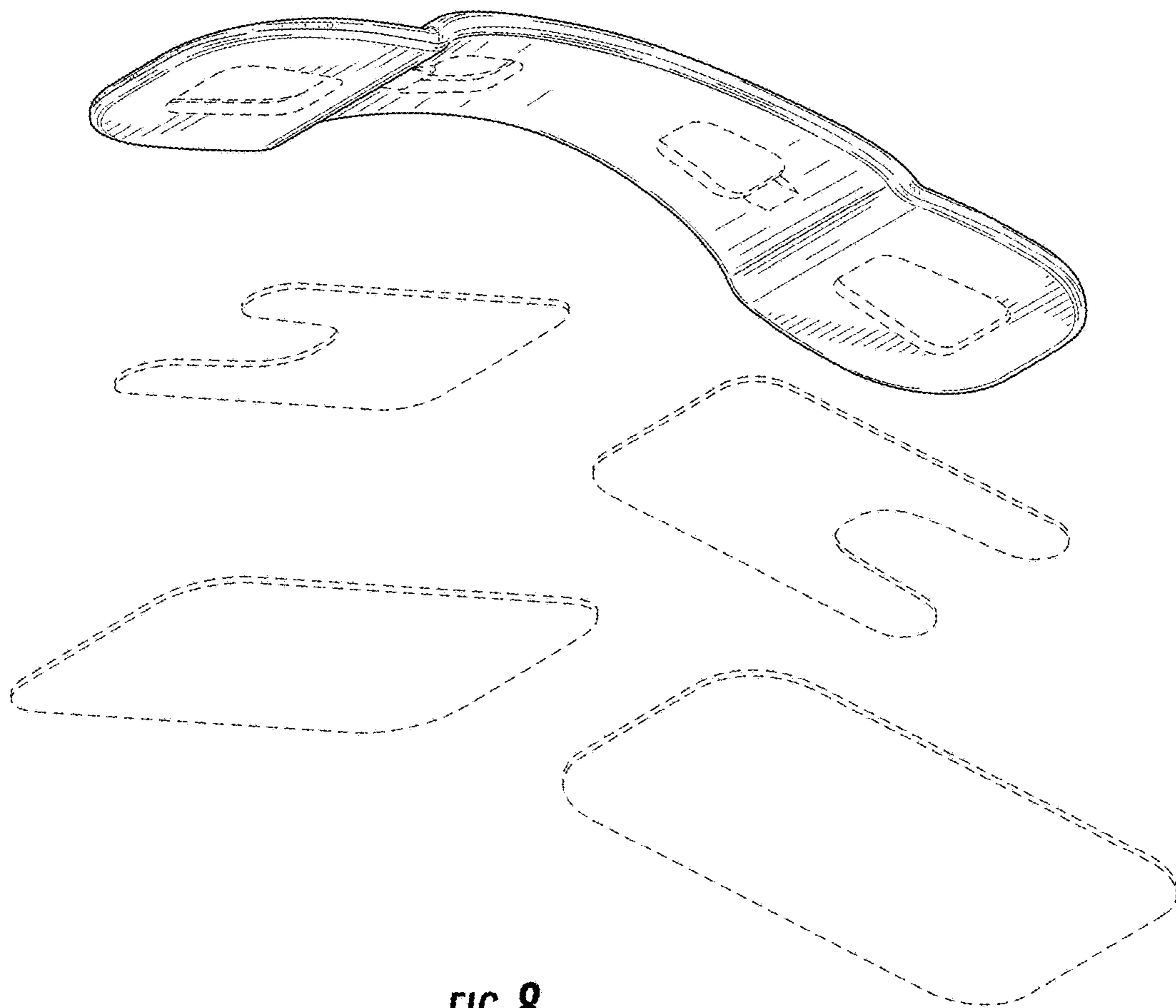

FIG. 8