



US00D876540S

(12) **United States Design Patent** (10) **Patent No.:** **US D876,540 S**  
**Shibata** (45) **Date of Patent:** **\*\* Feb. 25, 2020**

(54) **MARKING PEN**  
(71) Applicant: **PENTEL KABUSHIKI KAISHA,**  
Tokyo (JP)  
(72) Inventor: **Tomoaki Shibata,** Tokyo (JP)  
(73) Assignee: **PENTEL KABUSHIKI KAISHA (JP)**  
(\*\*) Term: **15 Years**  
(21) Appl. No.: **29/694,492**  
(22) Filed: **Jun. 11, 2019**

D458,964 S \* 6/2002 Nakazawa ..... D19/173  
D472,578 S 4/2003 Plantz ..... D19/177  
D476,685 S 7/2003 Metaxatos ..... D19/171  
7,059,796 B2 6/2006 Lewis et al. .... 401/107  
D525,302 S 7/2006 Togawa ..... D19/172  
D527,765 S \* 9/2006 Togawa ..... D19/172  
D533,591 S \* 12/2006 Togawa ..... D19/174  
D551,710 S 9/2007 Tsuchida ..... D19/174  
D559,317 S 1/2008 Ikeda ..... D19/171  
(Continued)

**FOREIGN PATENT DOCUMENTS**

JP D1288704 11/2006  
JP D1535891 9/2015

**OTHER PUBLICATIONS**

Notification of Reasons for Refusal together with English language translation thereof, dated Sep. 19, 2017 in Japanese Application No. 2017-013283.

(Continued)

*Primary Examiner* — Elizabeth A. Albert  
(74) *Attorney, Agent, or Firm* — Adams & Wilks

(57) **CLAIM**

The ornamental design for a marking pen, as shown and described.

**DESCRIPTION**

FIG. 1 is a perspective view of a marking pen showing my new design;  
FIG. 2 is a front view thereof;  
FIG. 3 is a rear view thereof;  
FIG. 4 is a left side view thereof;  
FIG. 5 is a right side view thereof;  
FIG. 6 is a top view thereof;  
FIG. 7 is a bottom view thereof;  
FIG. 8 is an enlarged left side view thereof; and,  
FIG. 9 is an enlarged right side view thereof.

**1 Claim, 4 Drawing Sheets**

**Related U.S. Application Data**

(62) Division of application No. 29/630,224, filed on Dec. 20, 2017.

(30) **Foreign Application Priority Data**

Jun. 20, 2017 (JP) ..... 2017-013283  
Jun. 20, 2017 (JP) ..... 2017-013284

(51) **LOC (12) Cl.** ..... **19-06**

(52) **U.S. Cl.**  
USPC ..... **D19/173; D19/921**

(58) **Field of Classification Search**  
USPC ..... D19/115–204; D14/411  
CPC . B43K 5/005; B43K 7/12; B43K 8/04; B43K  
8/06; B43K 19/00; B43K 19/02; B43K  
19/14; B43K 21/006; B43K 21/06  
See application file for complete search history.

(56) **References Cited**

**U.S. PATENT DOCUMENTS**

D146,335 S 2/1947 Colomy ..... D19/171  
2,528,709 A 11/1950 Raymond ..... 15/424  
D303,992 S 10/1989 Grotzsch ..... D19/187  
D321,719 S 11/1991 Nitta ..... D19/173  
D324,238 S 2/1992 Nitta ..... D19/173  
5,577,850 A 11/1996 Mishima ..... 401/83

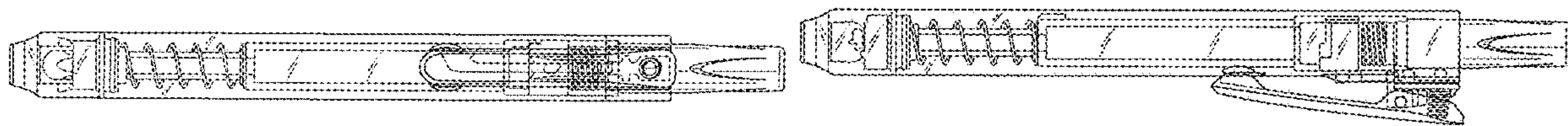

(56)

References Cited

U.S. PATENT DOCUMENTS

D561,835 S 2/2008 Nishida ..... D19/196  
 7,341,388 B2 3/2008 Carroll ..... 401/107  
 D569,909 S 5/2008 Shibata ..... D19/173  
 D569,911 S \* 5/2008 Kusaba ..... D19/195  
 D570,914 S 6/2008 Satoh ..... D19/195  
 D574,429 S 8/2008 Kusaba ..... D19/172  
 D575,819 S 8/2008 Nishida ..... D19/172  
 D582,979 S 12/2008 Leibeck ..... D19/173  
 D603,451 S 11/2009 Gerules ..... D19/172  
 D603,897 S \* 11/2009 Nakazawa ..... D19/174  
 D607,935 S \* 1/2010 Shimada ..... D19/172  
 D612,888 S 3/2010 Rolion ..... D19/171  
 D613,337 S 4/2010 Pearson ..... D19/174  
 D616,497 S \* 5/2010 Shiina ..... D19/173  
 D629,461 S 12/2010 Shibata ..... D19/173  
 7,850,382 B2 12/2010 Hayes ..... 251/298  
 D631,915 S 2/2011 Stukenkemper ..... D19/187  
 D641,784 S 7/2011 Lira-Nunez ..... D19/171  
 D643,877 S 8/2011 Soetewey ..... D19/171  
 D648,790 S \* 11/2011 Nakazawa ..... D19/171

D653,706 S 2/2012 Lira-Nunez ..... D19/201  
 D660,357 S 5/2012 Lira-Nunez ..... D19/172  
 8,245,359 B2 8/2012 Fujihara ..... 24/11 HC  
 8,246,265 B2 8/2012 Hayes ..... 251/228  
 8,393,814 B2 3/2013 Challman ..... 401/108  
 D698,390 S \* 1/2014 Shimizu ..... D19/179  
 D701,573 S 3/2014 Ikeda ..... D19/171  
 D740,365 S \* 10/2015 Vadenne ..... D19/183  
 D758,490 S \* 6/2016 Shibata ..... D19/174  
 D797,852 S \* 9/2017 Oltman ..... D19/173  
 9,784,294 B2 10/2017 Uchida  
 D822,112 S \* 7/2018 Nakazawa ..... D19/173  
 2009/0142124 A1 6/2009 Dylkiewicz ..... 401/108  
 2009/0165261 A1 7/2009 Furukawa ..... 24/11 R  
 2018/0056706 A1 \* 3/2018 Ballot ..... A46B 11/001

OTHER PUBLICATIONS

Notification of Reasons for Refusal together with English language translation thereof, dated Sep. 19, 2017 in Japanese Application No. 2017-013284.

\* cited by examiner

Fig. 1

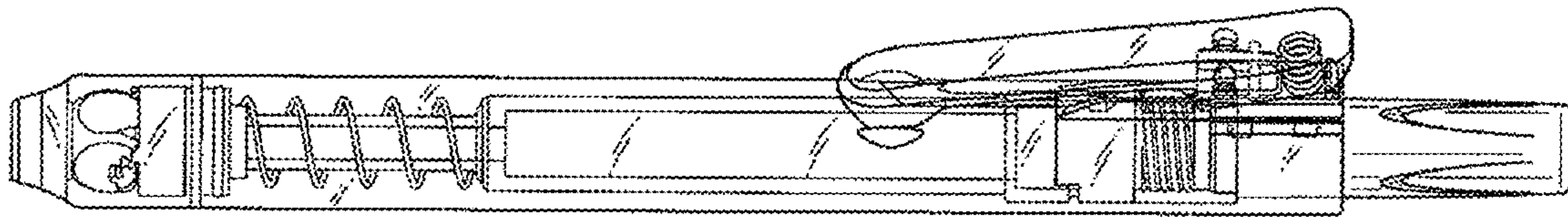

Fig. 2



Fig. 3

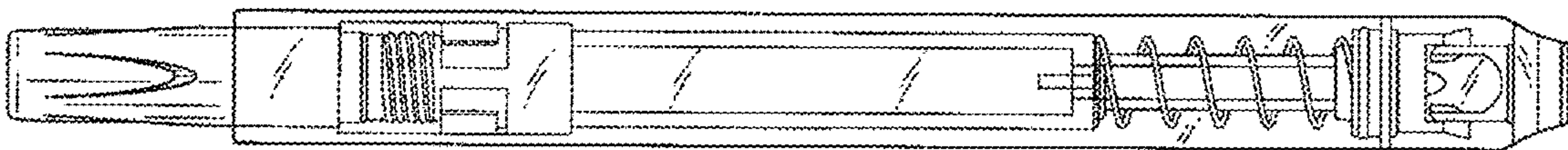



Fig. 4

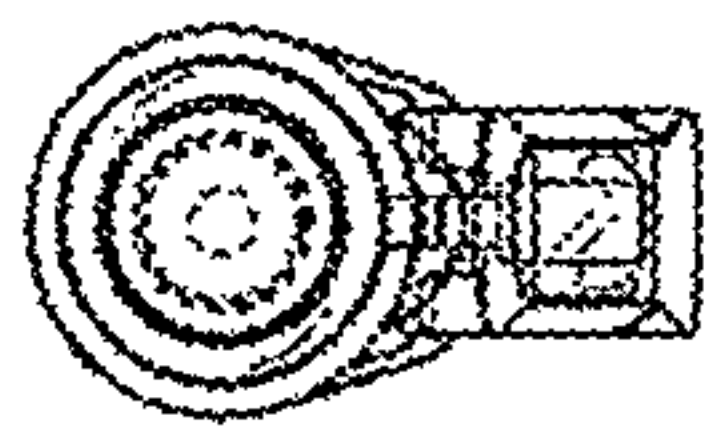

Fig. 5

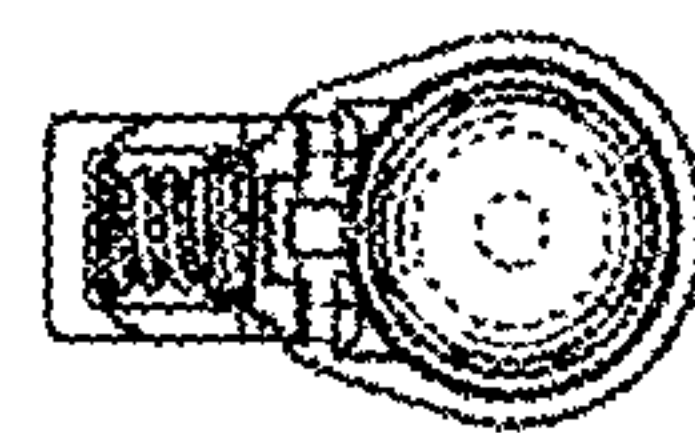

Fig. 6

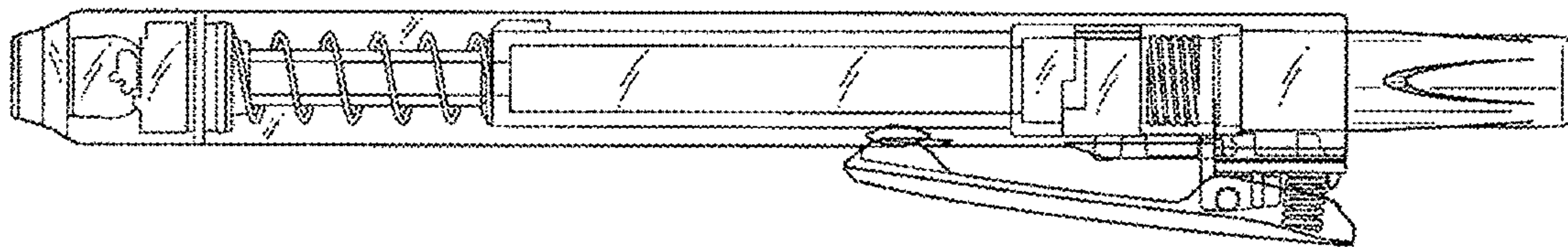

Fig. 7

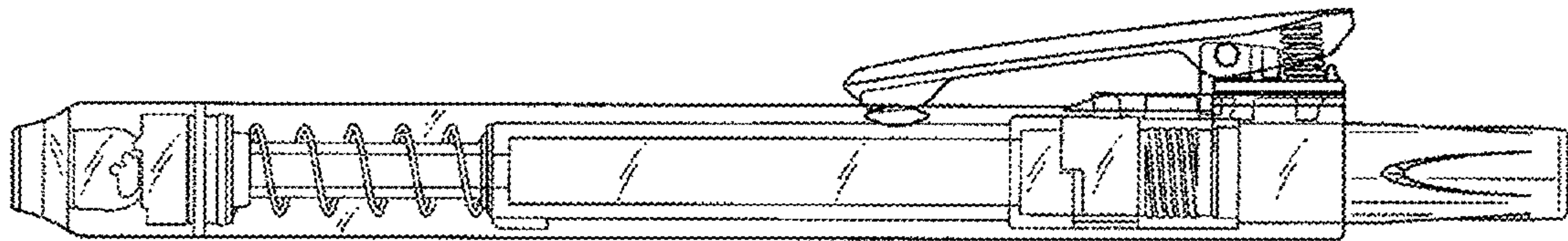

Fig. 8

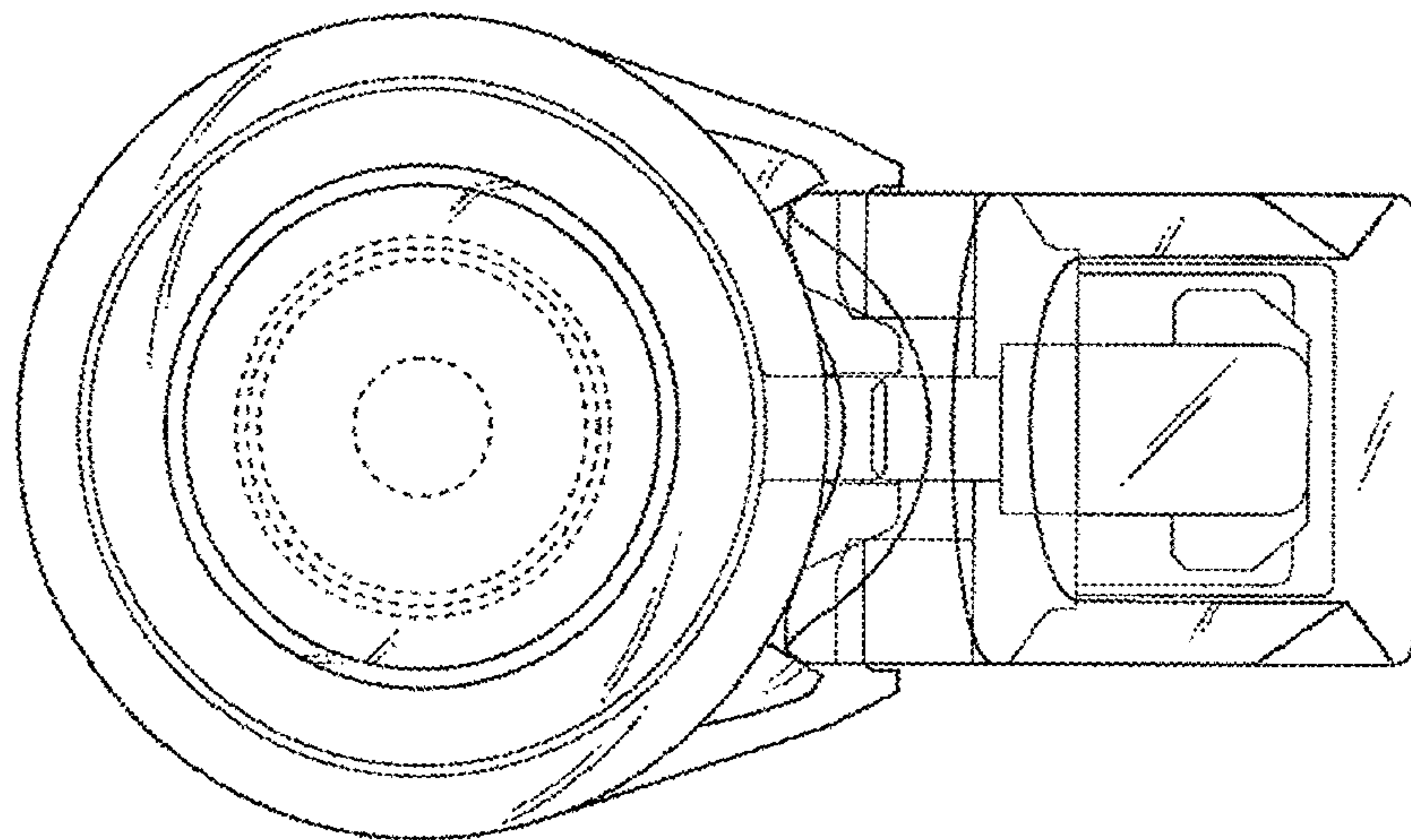

Fig. 9

