



US00D876493S

(12) **United States Design Patent** (10) **Patent No.:** **US D876,493 S**
Fidler (45) **Date of Patent:** **** Feb. 25, 2020**

(54) **REFRIGERATOR**
(71) Applicant: **Furrion Property Holding Limited,**
Hong Kong (HK)
(72) Inventor: **Matthew David Fidler,** Hong Kong
(HK)
(73) Assignee: **Furrion Property Holding Limited,**
Hong Kong (HK)
(**) Term: **15 Years**

D588,172 S 3/2009 Yang
D610,173 S 2/2010 Kim
D629,023 S 12/2010 Jeon et al.
D647,112 S * 10/2011 Okamoto D15/81
D648,359 S 11/2011 Yu et al.
D674,415 S 1/2013 Lee et al.
D703,245 S 4/2014 Seo et al.
D707,268 S 6/2014 Yong et al.
D709,533 S 7/2014 Park et al.
D709,534 S 7/2014 Park et al.
D711,937 S 8/2014 Boo et al.
D713,428 S 9/2014 Cho et al.
D714,356 S 9/2014 Heo et al.

(Continued)

(21) Appl. No.: **29/643,855**
(22) Filed: **Apr. 12, 2018**
(51) **LOC (12) Cl.** **15-07**
(52) **U.S. Cl.**
USPC **D15/86**
(58) **Field of Classification Search**
USPC D15/79-91
CPC F25D 17/065; F25D 23/028; F25D 23/04;
F25D 21/00; F25D 21/006; F25D 21/008;
F25D 21/04; F25D 21/08; F25D 21/14;
F25D 2317/061; F25D 2317/062; F25D
23/065; F25D 23/067; F25D 2400/02;
F25D 2500/06; F25D 2600/06; F25D
2700/02; F25D 2700/14; F25D 29/00
See application file for complete search history.

OTHER PUBLICATIONS

“Refrigerator Handle and Lock” Design U.S. Appl. No. 29/643,861,
filed Apr. 12, 2018 under the applicant Property Holding Limited,
18 pages.

(Continued)

Primary Examiner — Khawaja Anwar
(74) *Attorney, Agent, or Firm* — Faegre Baker Daniels
LLP

(57) **CLAIM**

The ornamental design for a refrigerator, as shown and
described.

DESCRIPTION

FIG. 1 is a front perspective view of a refrigerator illustrat-
ing my new design;
FIG. 2 is a front view thereof;
FIG. 3 is a rear view thereof;
FIG. 4 is a left side view thereof;
FIG. 5 is a right side view thereof;
FIG. 6 is a top view thereof; and,
FIG. 7 is a bottom view thereof.
Broken lines illustrate features that form no part of the
claimed design.

(56) **References Cited**
U.S. PATENT DOCUMENTS
D422,286 S * 4/2000 Choi D15/81
D452,971 S * 1/2002 Funabasama D15/81
D467,596 S * 12/2002 Kim D15/81
D468,755 S * 1/2003 Muniz-Rivera D15/81
D501,488 S * 2/2005 Sato D15/81
D501,489 S 2/2005 Seo et al.
D501,663 S 2/2005 Yu et al.
D562,361 S 2/2008 Kwak
D568,910 S 5/2008 Seo et al.
D587,730 S 3/2009 Yang et al.

1 Claim, 7 Drawing Sheets

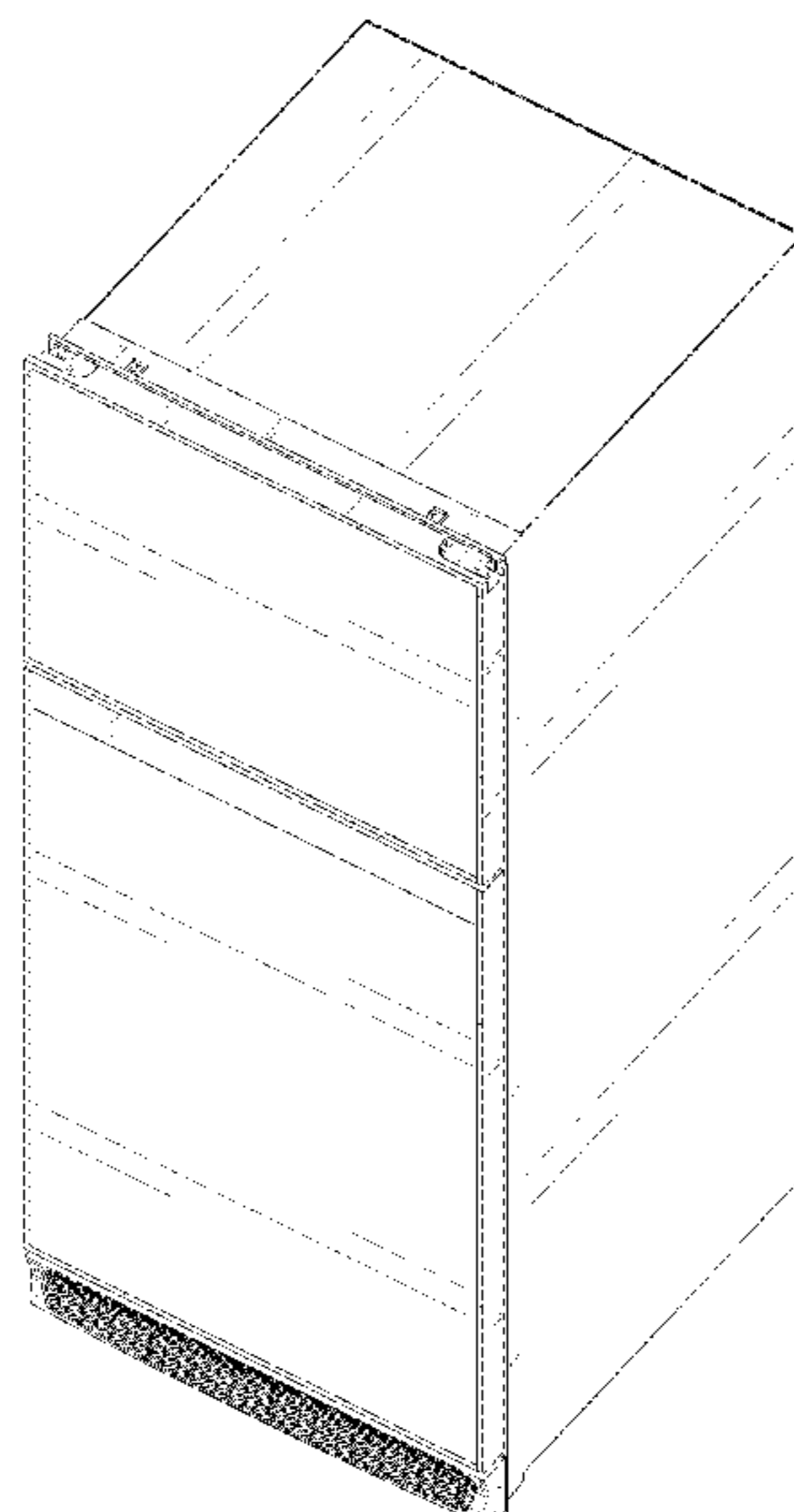

(56)

References Cited

U.S. PATENT DOCUMENTS

D714,366 S 9/2014 Jeon et al.
D714,843 S 10/2014 Jeon et al.
D716,349 S * 10/2014 Heo D15/81
D718,347 S * 11/2014 Cho D15/81
D736,275 S 8/2015 Kim et al.
D742,435 S 11/2015 Kim et al.
D748,166 S 1/2016 Jeon et al.
D752,660 S * 3/2016 Chen D15/81
D754,217 S 4/2016 Choi et al.
D754,760 S 4/2016 Seo et al.
D755,261 S 5/2016 Choi et al.
D756,427 S 5/2016 Ogg
D761,890 S 7/2016 Seo et al.
D778,965 S 2/2017 Kim et al.
D783,691 S 4/2017 Kim et al.
D787,573 S 5/2017 Kim et al.

D794,093 S 8/2017 Yoon et al.
D806,144 S 12/2017 Kim et al.
D806,145 S 12/2017 Kim et al.

OTHER PUBLICATIONS

“Refrigerator Handle and Lock” Design U.S. Appl. No. 29/643,885, filed Apr. 12, 2018 under the applicant Property Holding Limited, 20 pages.
“Refrigerator Light and Filter” Design U.S. Appl. No. 29/643,900, filed Apr. 12, 2018 under the applicant Property Holding Limited, 16 pages.
“Refrigerator” Design U.S. Appl. No. 29/643,856, filed Apr. 12, 2018 under the applicant Furrion Property Holding Limited, 15 pages.
“Refrigerator” Design U.S. Appl. No. 29/643,858, filed Apr. 12, 2018 under the applicant Furrion Property Holding Limited, 15 pages.

* cited by examiner

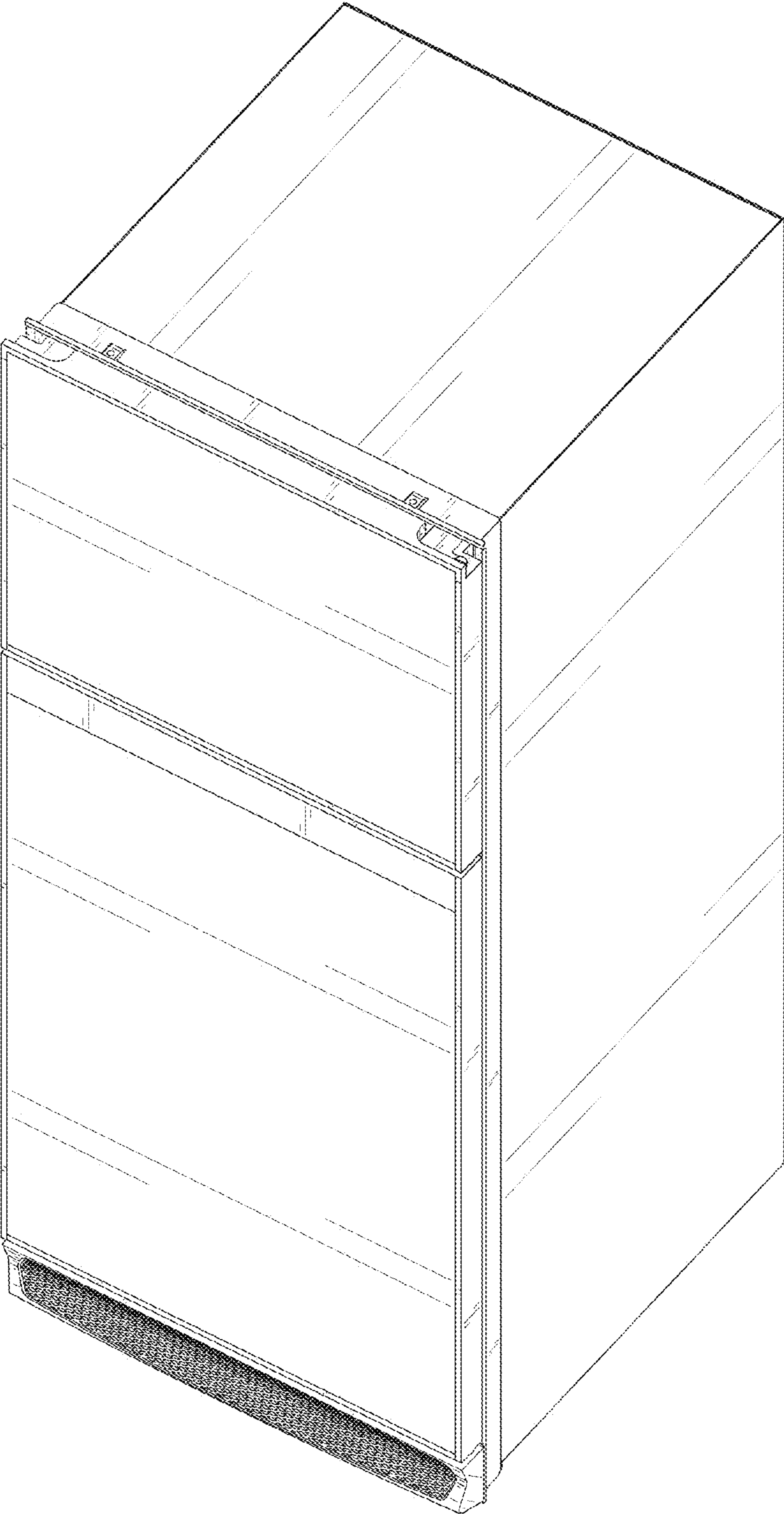

FIG. 1

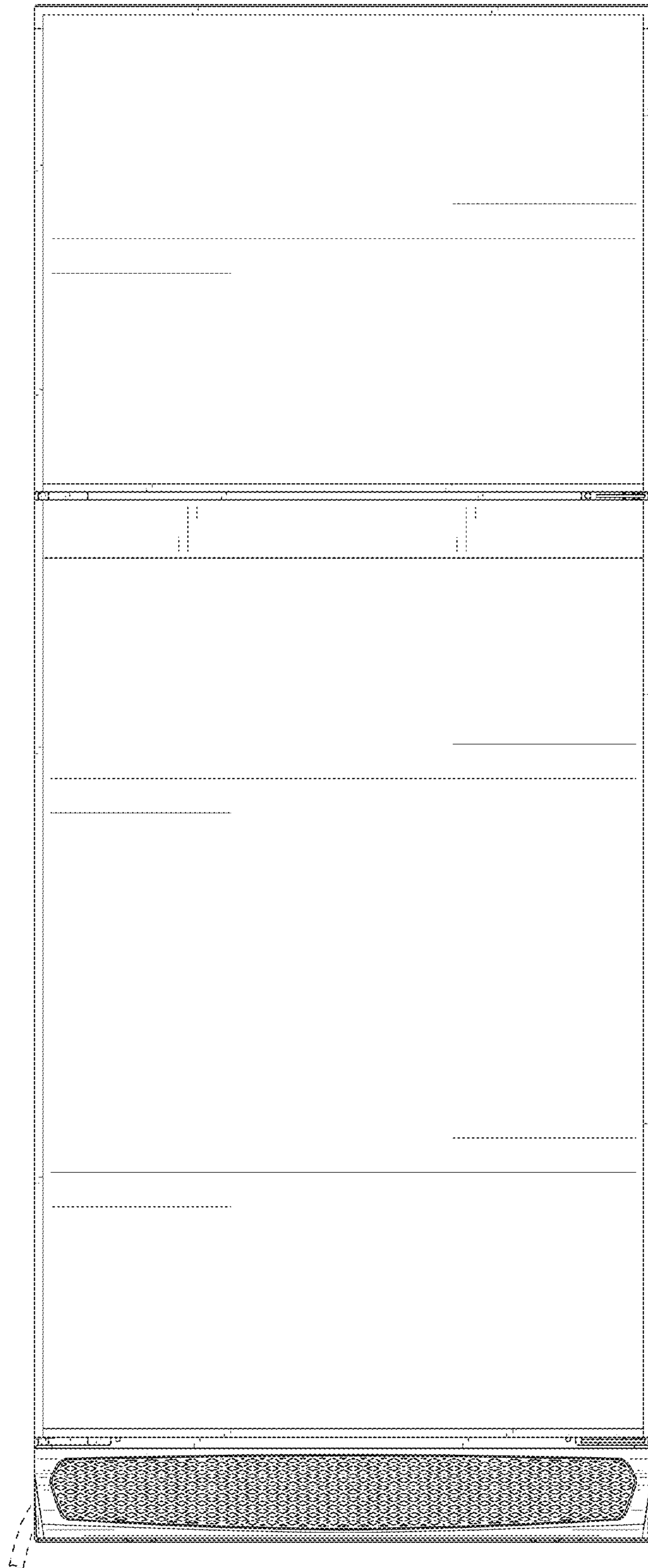

FIG. 2

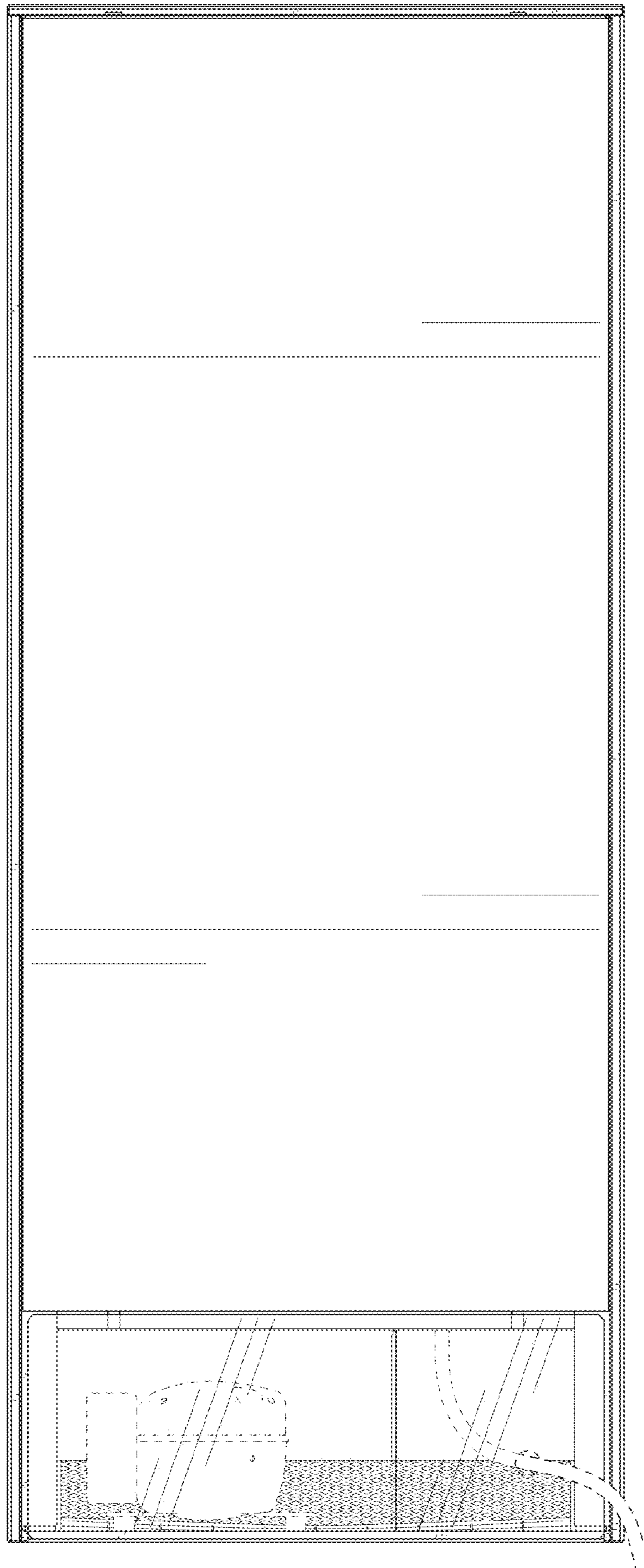

FIG. 3

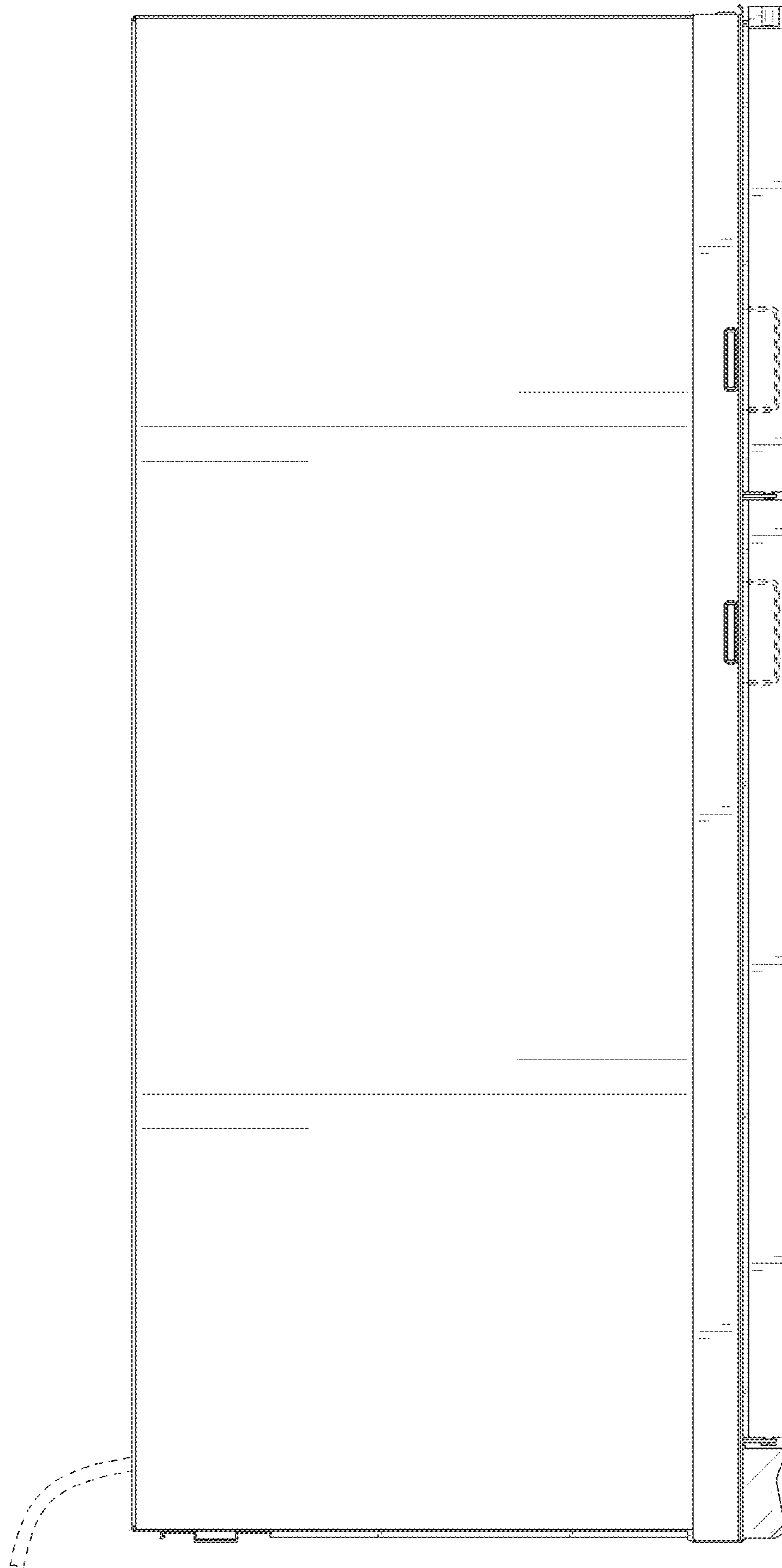

FIG. 4

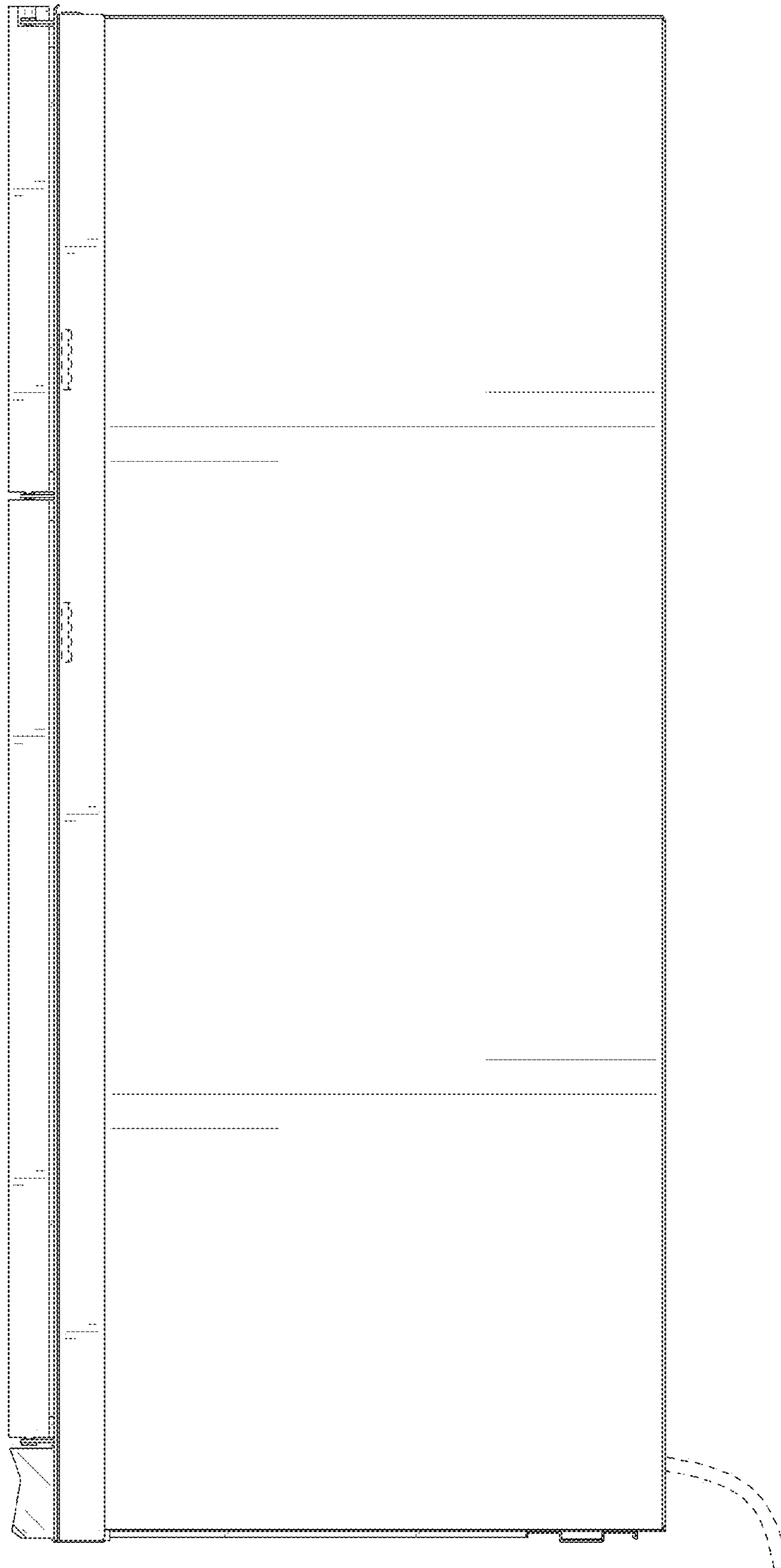

FIG. 5

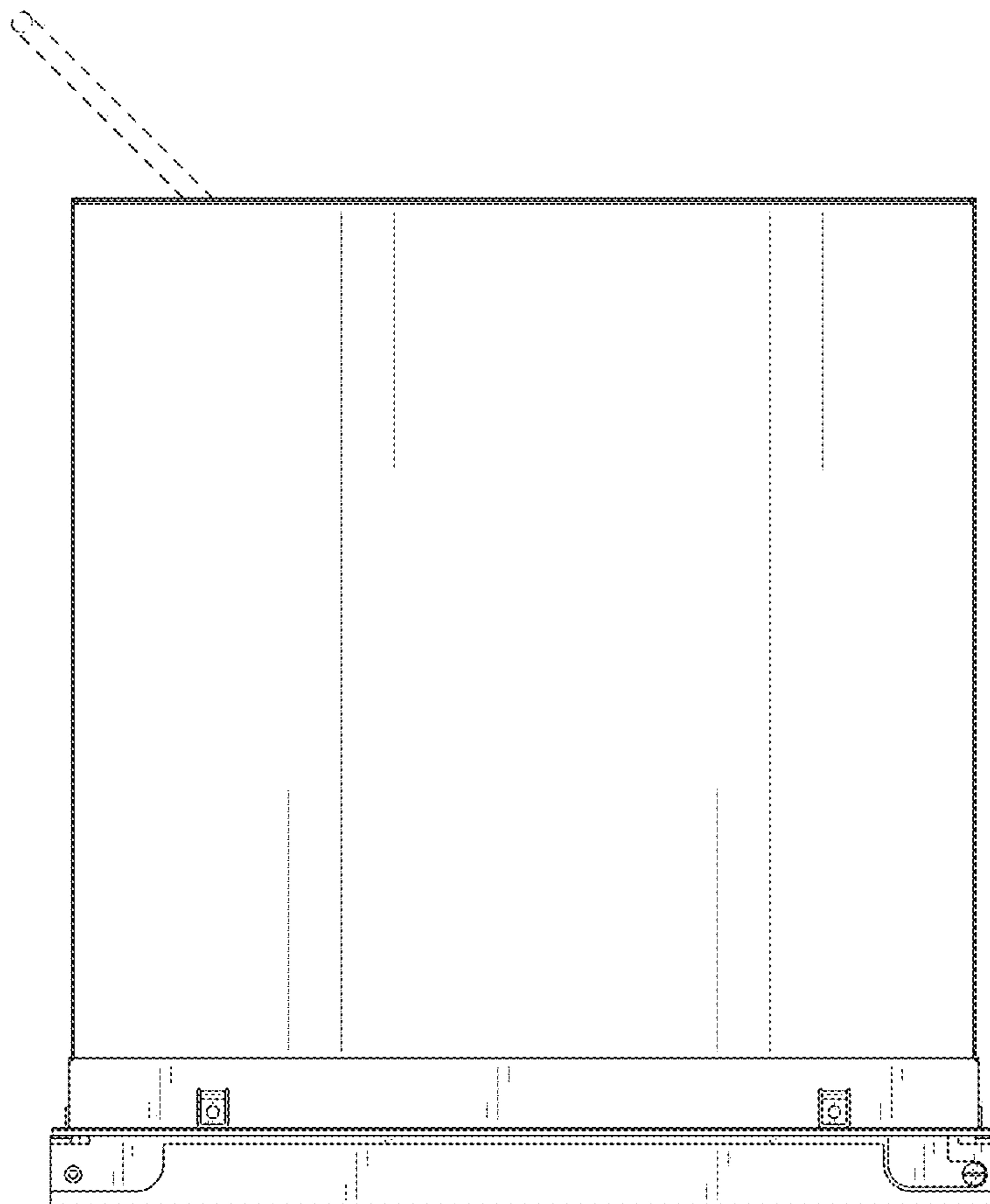

FIG. 6

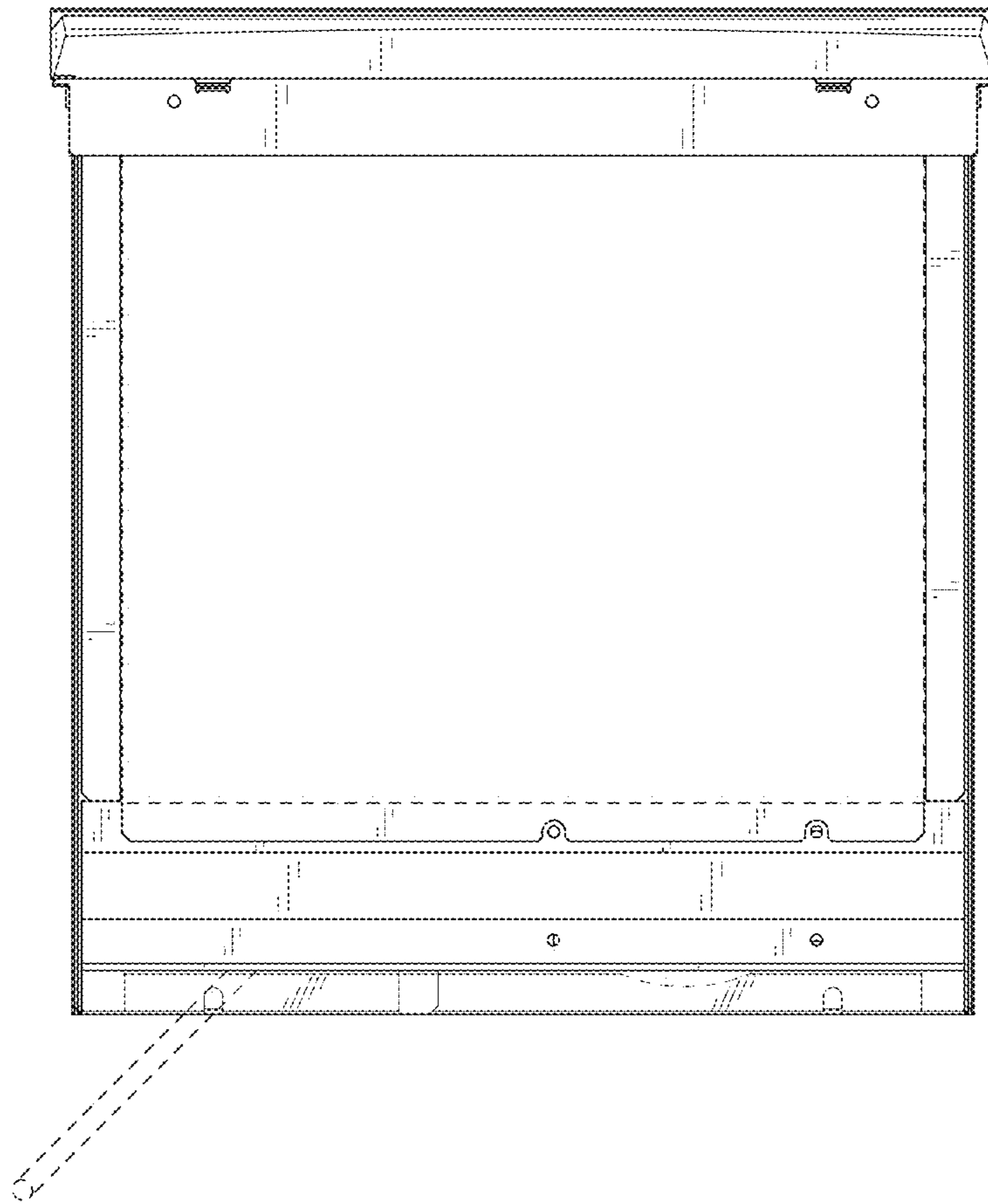

FIG. 7