



US00D876344S

(12) **United States Design Patent** (10) **Patent No.:** **US D876,344 S**
Mercer et al. (45) **Date of Patent:** **** Feb. 25, 2020**

(54) **CHARGING STATION**
(71) Applicant: **Volta Charging, LLC**, San Francisco, CA (US)
(72) Inventors: **Scott Mercer**, Pacifica, CA (US); **Alex Prodaniuk**, Pacifica, CA (US); **Kayla Matheus**, San Francisco, CA (US); **Christian Julio Santander**, Bad Riechenhall (DE); **Julian Schloemer**, Salzburg (AT); **Marco Wilhelm**, Salzburg (AT)
(73) Assignee: **VOLTA CHARGING, LCC**, San Francisco, CA (US)

D507,813 S 7/2005 Gillard
D542,849 S 5/2007 Hill et al.
D608,733 S 1/2010 Smith
D608,734 S 1/2010 Smith
D611,047 S 3/2010 Smith et al.
D613,683 S 4/2010 Baxter et al.

(Continued)

OTHER PUBLICATIONS

LinkPHL Digital Kiosks. "Philly now has a free digital WiFi, charging, information kiosk on Market Street", Emily Rolen, Dec. 11, 2018 [retrieved Apr. 15, 2019]. <https://www.phillyvoice.com/philly-linkphl-kiosks-free-digital-wifi-market-street-septa/>.

(Continued)

Primary Examiner — Rosemary K Tarcza
(74) *Attorney, Agent, or Firm* — Morgan, Lewis & Bockius LLP

(**) Term: **15 Years**

(21) Appl. No.: **29/711,546**

(22) Filed: **Oct. 31, 2019**

Related U.S. Application Data

(63) Continuation of application No. 29/691,015, filed on May 13, 2019.

(51) **LOC (12) Cl.** **13-02**

(52) **U.S. Cl.**
USPC **D13/107**

(58) **Field of Classification Search**
USPC D13/107–108, 110, 118–119, 184;
D14/307

CPC B60L 11/185; B60L 11/1825; B60L 11/1809; B60L 53/10; B60L 53/12; B60L 53/14; B60L 53/31; Y02T 90/10; Y02T 90/12; Y02T 90/121; Y02T 90/122; Y02T 90/127; Y02T 90/14

See application file for complete search history.

(56) **References Cited**

U.S. PATENT DOCUMENTS

D273,580 S 4/1984 Riumbau
D459,234 S 10/2002 Kajiura

(57) **CLAIM**

The ornamental design for a charging station, as shown and described.

DESCRIPTION

FIG. 1 is a front perspective view of the charging station showing our new design;
FIG. 2 is a rear perspective view thereof;
FIG. 3 is a front elevational view thereof;
FIG. 4 is a rear elevational view thereof;
FIG. 5 is a left-side elevational view thereof;
FIG. 6 is a right side elevational view thereof;
FIG. 7 is a top plan view thereof; and,
FIG. 8 is a bottom plan view thereof.
The broken lines immediately adjacent to the shaded areas represent the bounds of the claimed design, while all other broken lines depict portions of the charging station that form no part of the claimed design; the broken lines form no part of the claimed design.

1 Claim, 6 Drawing Sheets

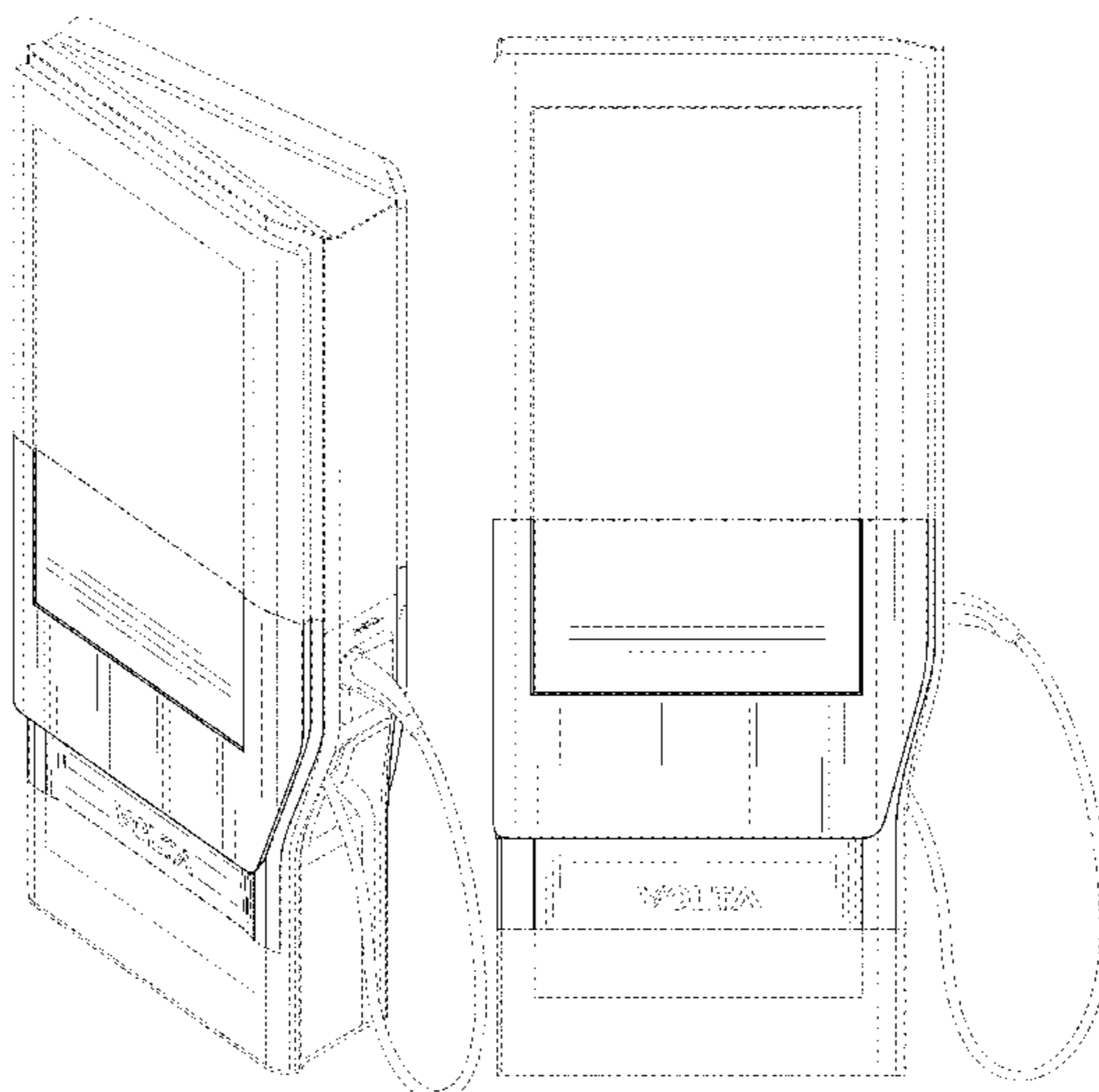

(56)

References Cited

U.S. PATENT DOCUMENTS

D618,168 S 6/2010 Baxter et al.
 D618,204 S 6/2010 Andre et al.
 D626,063 S 10/2010 Cutter et al.
 D626,064 S 10/2010 Cutter et al.
 D626,065 S 10/2010 Cutter et al.
 D633,908 S 3/2011 Arkana et al.
 D637,553 S 5/2011 Shin
 D637,595 S 5/2011 Mizusugi
 D639,800 S * 6/2011 Magruder D14/307
 D644,218 S 8/2011 Akana et al.
 D646,269 S 10/2011 Crick, Jr. et al.
 D647,053 S 10/2011 Gotou et al.
 D654,430 S 2/2012 Demers et al.
 D654,857 S 2/2012 Salazar et al.
 D654,858 S 2/2012 Salazar et al.
 D654,860 S 2/2012 Holthusen
 D654,861 S 2/2012 Holthusen
 D659,635 S 5/2012 Hou et al.
 D664,086 S 7/2012 Chin-Ho Kim et al.
 D664,087 S 7/2012 Chin-Ho Kim et al.
 D664,089 S 7/2012 Chin-Ho Kim et al.
 D669,071 S 10/2012 Akana et al.
 D674,334 S 1/2013 Cutter et al.
 D691,208 S 10/2013 Gorelick
 D696,658 S 12/2013 Winston et al.
 D708,572 S * 7/2014 Hou D13/107
 D708,573 S 7/2014 Gieniec et al.
 D708,574 S * 7/2014 Gieniec D13/107
 D712,349 S 9/2014 Ahlgren
 D720,285 S 12/2014 Gilomen
 D729,158 S * 5/2015 Gilomen D13/107
 D733,647 S * 7/2015 Farrell D13/107
 D749,503 S 2/2016 Ferguson et al.
 D771,562 S 11/2016 Dolle
 D776,651 S * 1/2017 Yates D14/307
 D778,818 S 2/2017 Bruining
 D783,596 S * 4/2017 Payne D14/307
 D788,098 S * 5/2017 Thornton D14/307
 D790,457 S 6/2017 Vargas et al.
 D816,077 S * 4/2018 Benic D14/307
 D830,969 S * 10/2018 Wang D13/107
 D833,387 S 11/2018 Baxter et al.
 D838,668 S 1/2019 Westfall et al.
 D844,559 S 4/2019 Mercer et al.
 D850,438 S * 6/2019 Koenigsknecht D14/307
 D858,435 S * 9/2019 Helnerus D13/107
 D858,512 S 9/2019 Angelopoulos
 D868,687 S 12/2019 de Silva et al.
 2010/0296234 A1 11/2010 Crick, Jr.
 2011/0145141 A1 6/2011 Blain
 2012/0181984 A1 7/2012 Okabayashi et al.
 2012/0262112 A1 10/2012 Ross
 2013/0069588 A1 3/2013 Oda et al.
 2013/0207606 A1 8/2013 Ranga et al.

OTHER PUBLICATIONS

Parsons, Sarah. "France Announces \$2.2 Billion Electric Car Charging Network." [retrieved on Dec. 28, 2012]. Retrieved from the

Internet: <[Bloomfield, Nikki Gordon. "Need an Electric Car Charging Station at Work? Here's One for Free." \[retrieved Nov. 7, 2012\]. Retrieved from the Internet: <\["Smart Grids, Fast Charging—Infrastructure for Electric Car." \\[retrieved on Nov. 7, 2012\\]. Retrieved from the Internet <\\["EV News: first hotel to install electric car charging station for guests." \\\[retrieved on Nov. 7, 2012\\\]. Retrieved from the Internet: <\\\["EV Charging Station, Volta—Honolulu, Hawaii." \\\\[retrieved on Dec. 30, 2012\\\\]. Retrieved from the Internet: <\\\\[Buffalo Niagara Medical Campus. "Electric Vehicle Charging Stations Installed Across Campus." \\\\\[retrieved on Dec. 30, 2012\\\\\]. Retrieved from the Internet: <\\\\\["Electric-Vehicle Charging Stations Available at ACC Campuses." \\\\\\[retrieved Dec. 30, 2012\\\\\\]. Retrieved from the Internet: <\\\\\\[* cited by examiner\\\\\\]\\\\\\(http://www.google.com/imgres?q=electric+vehicle+charging+stations&start=738&um=1&hl=en&tbo=d&biw=1440&bih=783&tbm=isch&tbnid=BCVZxvxp_xJfmM:&imgrefurl=http://Minsideacc.austfincc.edu/index.php/2012/01/13/electric-vehicle-charging-stations-available-at-acc-campuses/&docid=WIRnei3IJ_vhM&imgurl=http://insideacc.austfincc.edu/wp-content/uploads/HBC-Charging-Station>.</p>
</div>
<div data-bbox=\\\\\\)\\\\\]\\\\\(http://www.google.com/imgres?q=electric+vehicle-Fcharging+stations&start=554&um=1&hl=en&tbo=d&biw=1440&bih=783&tbm=isch&tbnid=5QoChyg4wMwOeM:&imgrefurl=http://www.bnmc.org/electric-vehicle-charging-stations-installed-across-campus/&docid=VINctdKztXxtKM&imgurl=http://www.bnmc.org/wp-content/uploads/charging-stations>.</p>
</div>
<div data-bbox=\\\\\)\\\\]\\\\(http://www.google.com/imgres?q=electric+vehicle-Fcharging+stations&start=307&num=10&um=1&hl=en&tbo=d&biw=1440&bih=783&tbm=isch&tbnid=78HBWHajq0_ydM:&imgrefurl=http://www.examiner.com/article/ev-news-first-hotel-to-install-electric-car-charging-station-for-guests&docid=Hv6RWGv08bpOOM&imgurl=http://www.examiner.com/images/blog/wysiwyg/image/>.</p>
</div>
<div data-bbox=\\\\)\\\]\\\(http://www.google.com/imgres?q=electric+vehicle+charging+stations&start=307&num=10&um=1&hl=en&tbo=d&biw=1440&bih=783&tbm=isch&tbnid=78HBWHajq0_ydM:&imgrefurl=http://www.examiner.com/article/ev-news-first-hotel-to-install-electric-car-charging-station-for-guests&docid=Hv6RWGv08bpOOM&imgurl=http://www.examiner.com/images/blog/wysiwyg/image/>.</p>
</div>
<div data-bbox=\\\)\\]\\(http://www.google.com/imgres?q=electric+vehicle+charging+stations&start=20&num=10&um=1&hl=en&tbo=d&biw=1440&bih=783&tbm=isch&tbnid=f4piNYxrLOy80M:&imgrefurl=http://www.impactlab.net/2008/07/28/smart-grids-fast-charging-infrastructure-for-electric-cars/&docid=3pBfeFH7Jg9mM&imgurl=http://www.impactlab.com/wp-content/uploads/2008/07/charging-station-london>.</p>
</div>
<div data-bbox=\\)\]\(http://www.google.com/imgres?q=electric+vehicle-Fcharging+stations&start=22&num=10&um=1&hl=en&tbo=d&biw=1440&bih=783&tbm=isch&tbnid=njkABlvYoMe0IM:&imgrefurl=http://www.greencarreports.com/news/1079118_need-an-electric-car-charging-station-at-work-heres-one-for-free&docid=7ywn-IMbSk0AgM&imgurl=http://images.thecarconnection.com/smUchargepoint_100182292_s_n>.</p>
</div>
<div data-bbox=\)](http://www.google.com/imgres?q=electric+vehicle-Fcharging+stations&num=10&um=1&hl=en&tbo=d&biw=1440&bih=783&tbm=isch&tbnid=QfP2cslOfm0K2MAimgrefurl=http://inhabitat.com/massachusetts-set-to-install-100-ev-charging-stations/&docid=NKQtedu9SWSKBM&imgurl=http://assets.inhabitat.com/wp-content/uploads/>.</p>
</div>
<div data-bbox=)

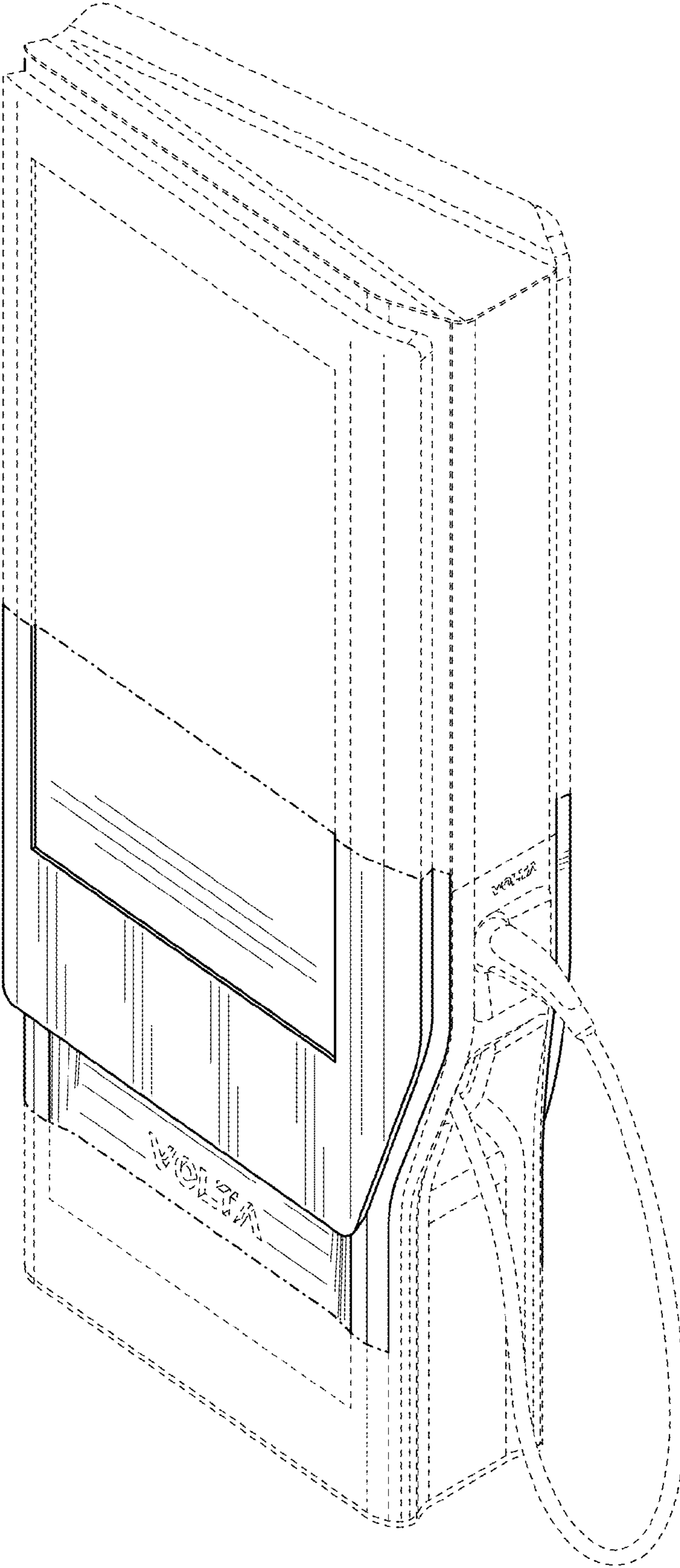

FIG. 1

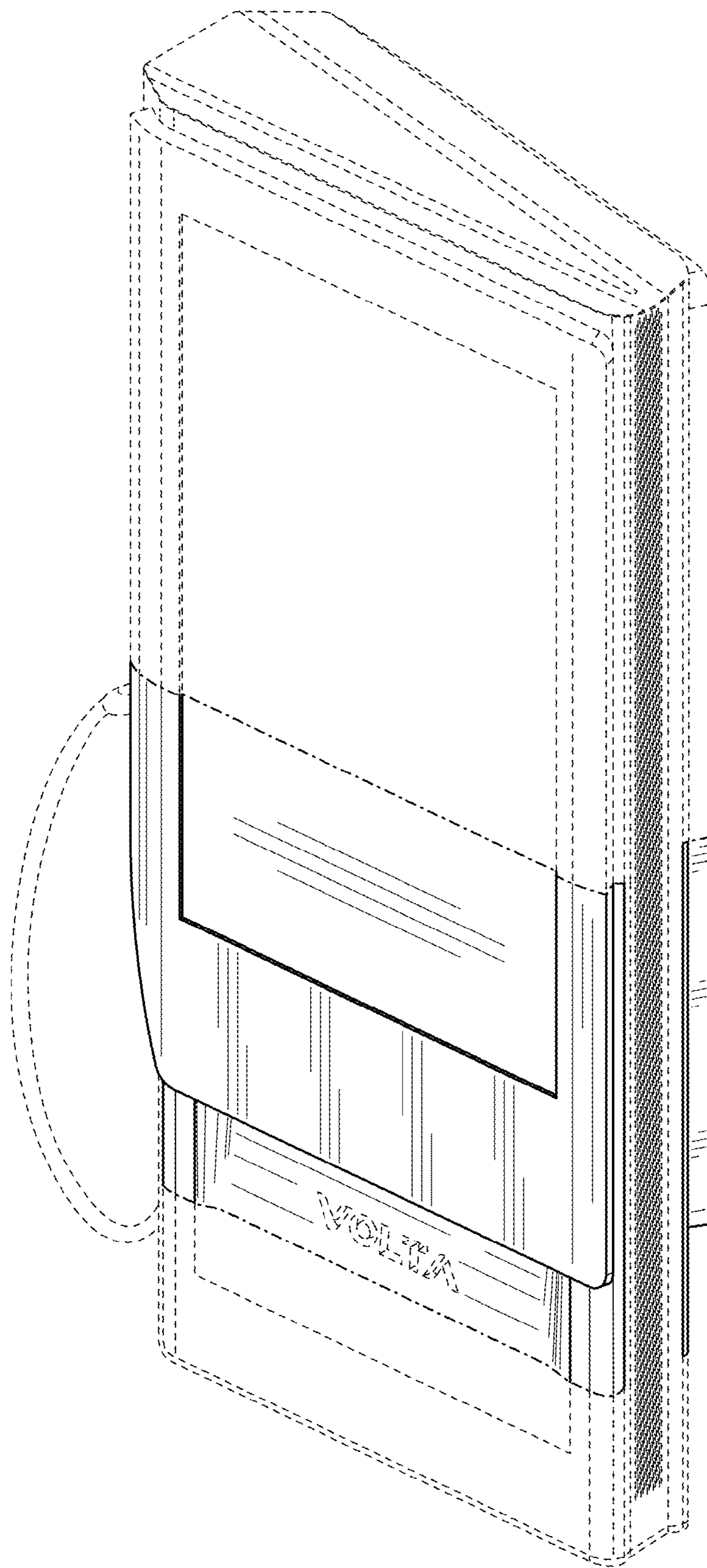

FIG. 2

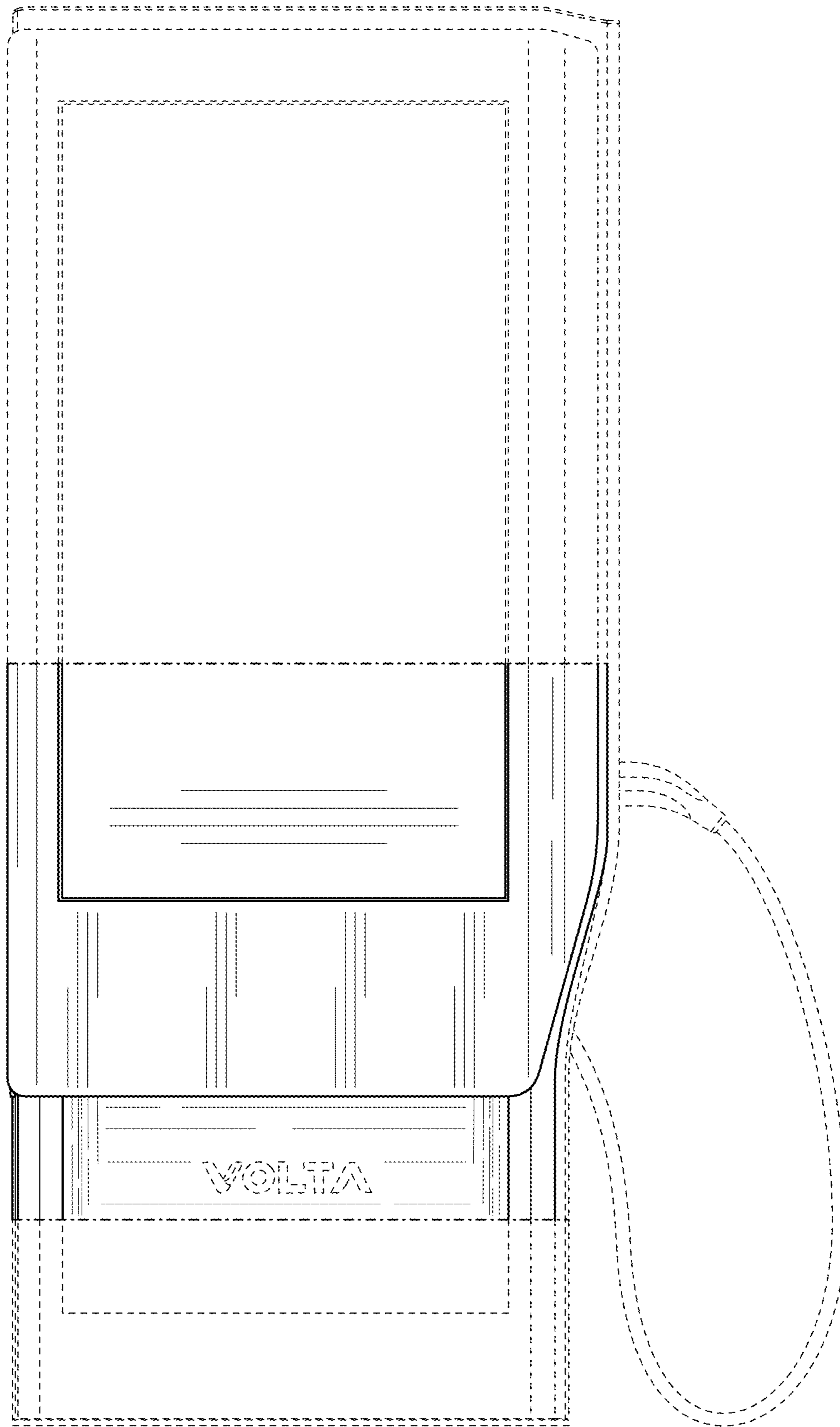

FIG. 3

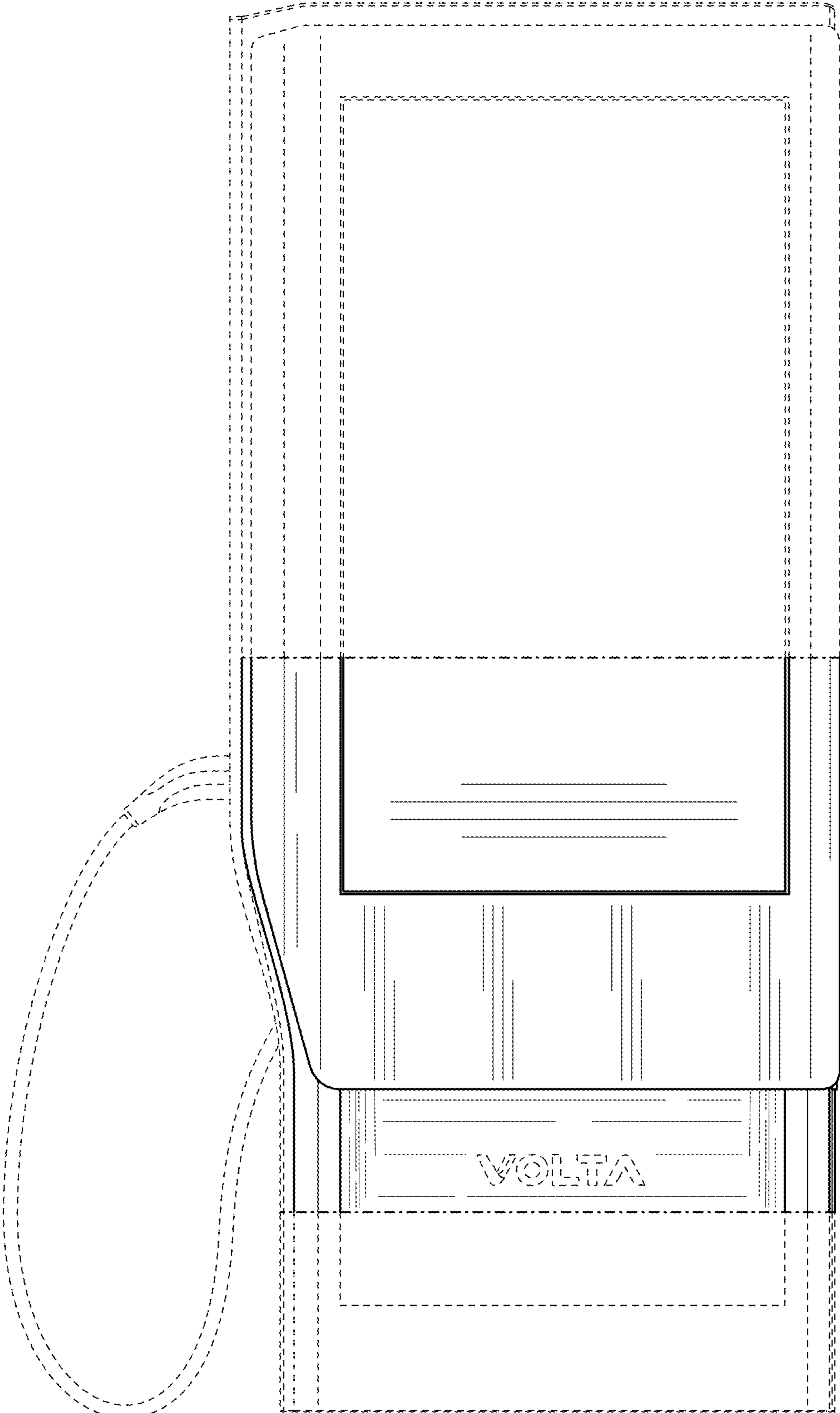

FIG. 4

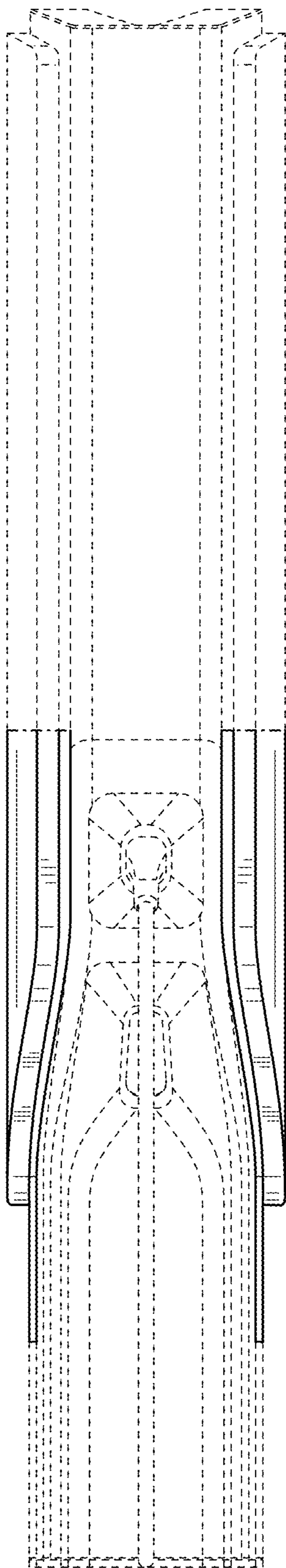

FIG. 5

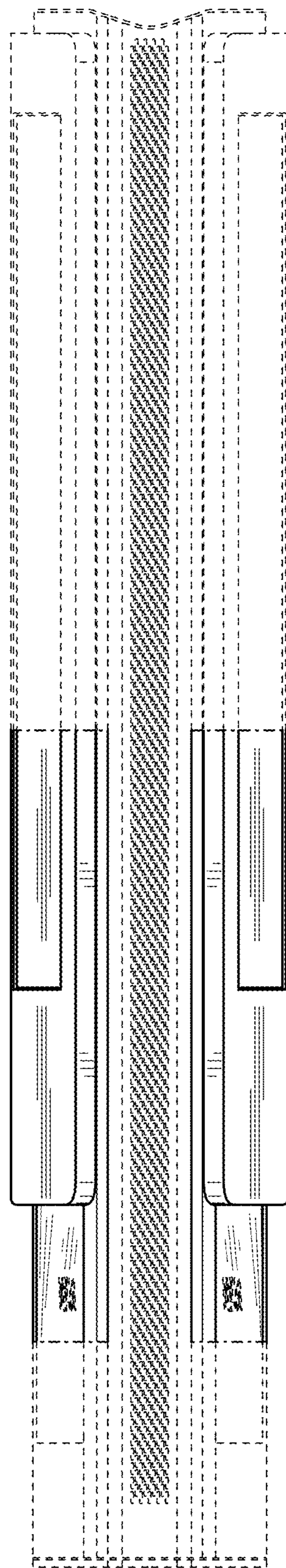

FIG. 6

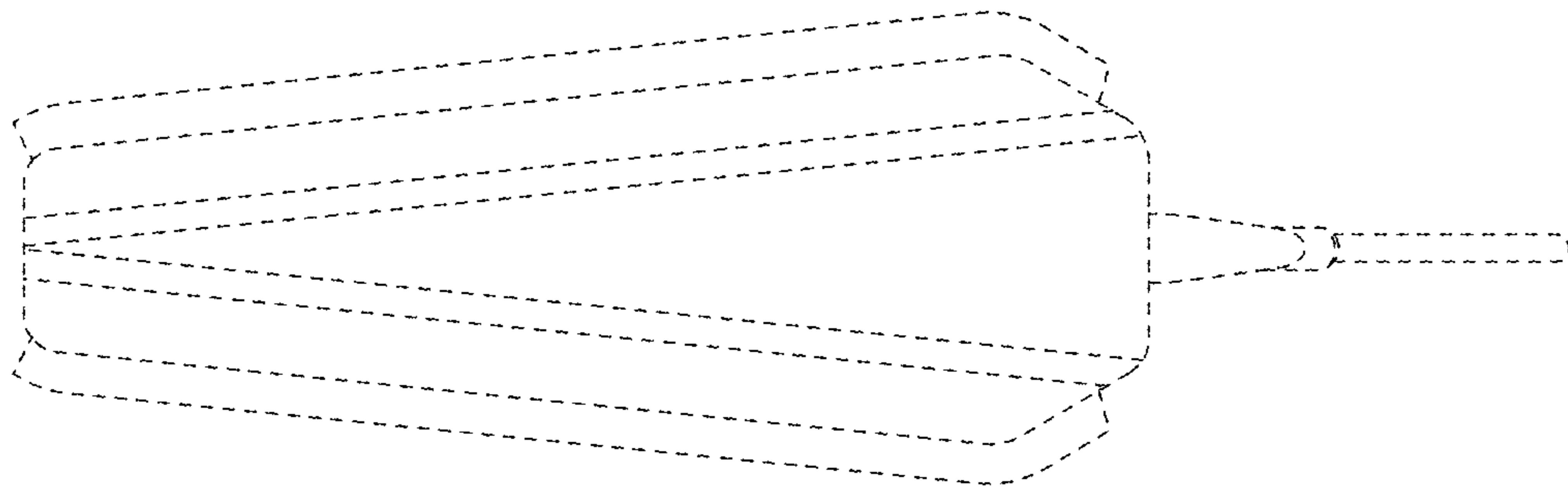

FIG. 7

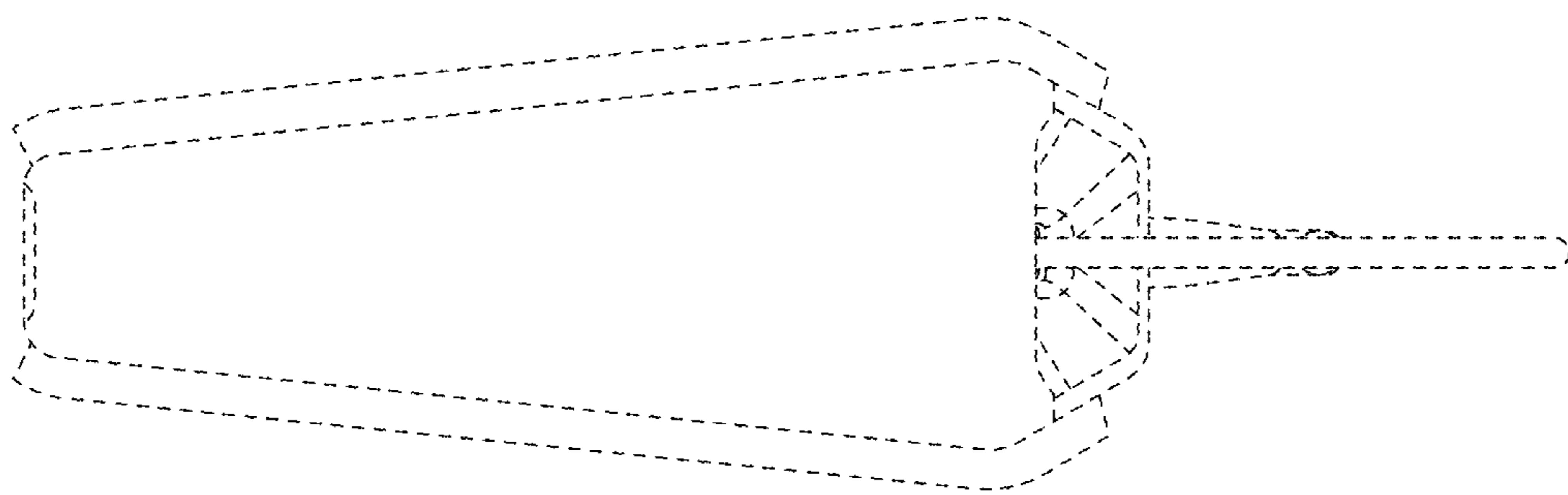

FIG. 8

UNITED STATES PATENT AND TRADEMARK OFFICE
CERTIFICATE OF CORRECTION

PATENT NO. : D876,344 S
APPLICATION NO. : 29/711546
DATED : February 25, 2020
INVENTOR(S) : Scott Mercer et al.

Page 1 of 1

It is certified that error appears in the above-identified patent and that said Letters Patent is hereby corrected as shown below:

On the Title Page

Item “(73) Assignee,”: change “LCC” to “LLC”

Signed and Sealed this
Twenty-first Day of April, 2020

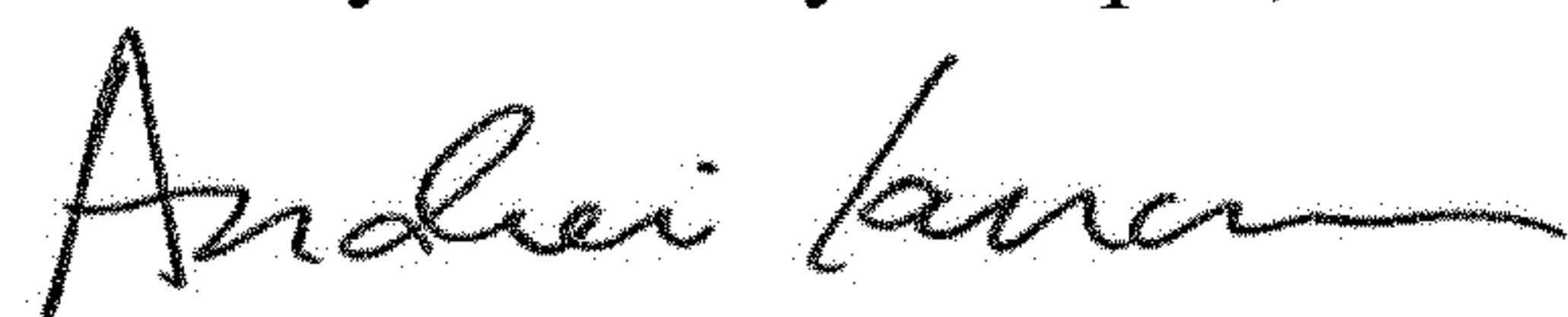

Andrei Iancu
Director of the United States Patent and Trademark Office