



US00D876244S

(12) **United States Design Patent** (10) **Patent No.:** **US D876,244 S**  
**Park et al.** (45) **Date of Patent:** **\*\* Feb. 25, 2020**

(54) **WRISTBAND**

(71) Applicants: **Anhui Huami Information Technology Co., Ltd.**, Hefei, Anhui (CN); **Huami Inc.**, Mountain View, CA (US)

(72) Inventors: **Jihyun Park**, Anhui (CN); **Jing Zhao**, Anhui (CN)

(73) Assignees: **Anhui Huami Information Technology Co., Ltd.**, Hefei, Anhui (CN); **Huami Inc.**, Mountain View, CA (US)

(\*\*) Term: **15 Years**

(21) Appl. No.: **29/705,856**

(22) Filed: **Sep. 16, 2019**

**Related U.S. Application Data**

(63) Continuation of application No. 29/616,770, filed on Sep. 8, 2017, now Pat. No. Des. 866,350.

(30) **Foreign Application Priority Data**

May 26, 2017 (CN) ..... 2017 3 0206031

(51) **LOC (12) Cl.** ..... **10-02**

(52) **U.S. Cl.**  
USPC ..... **D10/32**

(58) **Field of Classification Search**  
USPC ..... D10/30-32, 38-39, 40-41, 44, 65, 70,  
D10/97-98, 99-102, 126; D14/344;  
D24/167, 186

CPC ..... G04B 19/00; G04B 19/025; G04B 19/06;  
G04B 19/08; G04B 19/085; G04B  
19/087; G04B 19/10; G04B 19/103;  
G04B 19/106; G04B 19/04; G04B  
19/042; G04B 19/046; G04B 19/048;  
G04B 45/061

See application file for complete search history.

(56) **References Cited**

U.S. PATENT DOCUMENTS

D494,070 S \* 8/2004 Debetaz ..... D10/32  
D584,170 S \* 1/2009 Morrison ..... D10/32

(Continued)

OTHER PUBLICATIONS

Xiaomi Weloop Hey 3s | posted by Smart Tech Info at youtube.com  
Apr. 2017 [online]. [retrieved Jul. 8, 2019] from Internet: <https://  
www.youtube.com/watch?v=9LhhqBEw1y8 (Year: 2017).\*

(Continued)

*Primary Examiner* — Sandra S Snapp

*Assistant Examiner* — Katherine Glennon

(74) *Attorney, Agent, or Firm* — Young Basile Hanlon &  
MacFarlane, P.C.

(57) **CLAIM**

The ornamental design for a wristband, as shown and described.

**DESCRIPTION**

FIG. 1 is a front view of a wristband showing our new design.

FIG. 2 is a rear view of the wristband of FIG. 1.

FIG. 3 is a left side view of the wristband of FIG. 1.

FIG. 4 is a right side view of the wristband of FIG. 1.

FIG. 5 is a top plan view of the wristband of FIG. 1.

FIG. 6 is a bottom plan view of the wristband of FIG. 1; and,  
FIG. 7 is a front, right perspective view of the wristband of  
FIG. 1.

The ornamental design which is claimed is shown in solid lines in the drawings. The broken lines in FIGS. 1-4 and 7 illustrate portions of the wristband that form no part of the claimed design. The shade lines in the figures show contour and not surface ornamentation. The shade lines form no part of the claimed design.

**1 Claim, 4 Drawing Sheets**

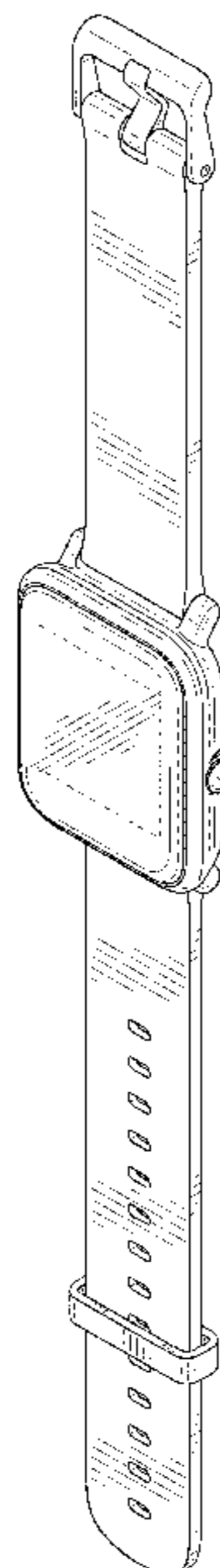

(56)

**References Cited**

U.S. PATENT DOCUMENTS

D636,687 S \* 4/2011 Morrison ..... D10/39  
 D638,312 S \* 5/2011 Jacobs ..... D10/32  
 D724,556 S \* 3/2015 Choi ..... D10/32  
 D729,237 S \* 5/2015 Fagnot ..... D14/344  
 D739,768 S \* 9/2015 Hanshew ..... D10/30  
 D741,726 S \* 10/2015 Akana ..... D10/30  
 D743,278 S \* 11/2015 Solomon ..... D10/38  
 D745,515 S \* 12/2015 Solomon ..... D14/344  
 D751,550 S \* 3/2016 Solomon ..... D10/38  
 D757,567 S \* 5/2016 Henderson ..... D10/30  
 D760,716 S \* 7/2016 Akana ..... D14/344  
 D760,717 S \* 7/2016 Solomon ..... D14/344  
 D768,623 S \* 10/2016 Zou ..... D10/39  
 D772,866 S \* 11/2016 Park ..... D10/38  
 D782,475 S \* 3/2017 Yu ..... D11/5  
 D784,325 S \* 4/2017 Kim ..... D14/341  
 D784,831 S \* 4/2017 Akana ..... D10/38  
 D786,241 S \* 5/2017 Chuang ..... D14/344

D802,587 S \* 11/2017 Lee ..... D14/344  
 D828,352 S \* 9/2018 Akana ..... D14/344  
 D836,466 S \* 12/2018 Shi ..... D10/32  
 D837,206 S \* 1/2019 Guan ..... D14/344  
 D839,753 S \* 2/2019 Domke ..... D10/30  
 D841,005 S \* 2/2019 Lin ..... D14/344  
 D843,864 S \* 3/2019 Vandebussche ..... D10/70  
 2016/0183390 A1\* 6/2016 Yang ..... G04B 37/08  
 361/679.01  
 2017/0181510 A1\* 6/2017 Novak ..... A44C 5/147  
 2018/0271231 A1\* 9/2018 Zeng ..... A44C 5/14

OTHER PUBLICATIONS

WeLoop Hey S3 Smartwatch | posted at blogrope.com May 2017  
 [online]. [retrieved Jul. 8, 2019] from Internet: <<https://blog-rope.com/web/xiaomi-launches-weloop-hey-s3-snnartwatch-heres-specifics/>> (Year: 2017).\*

\* cited by examiner

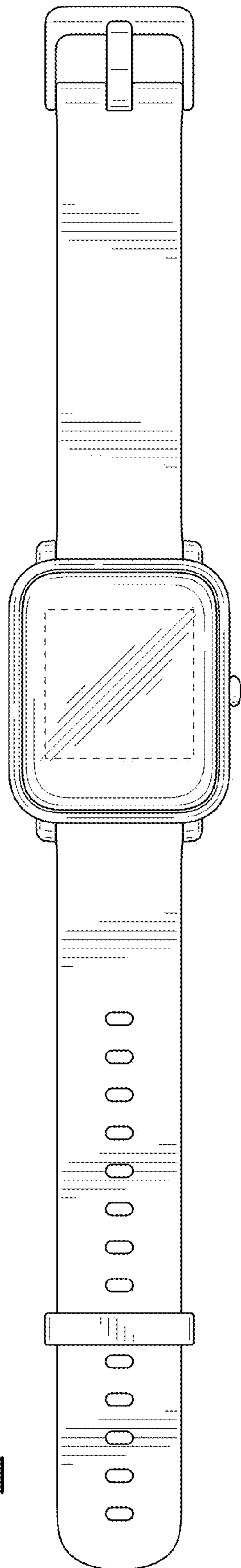

FIG. 1

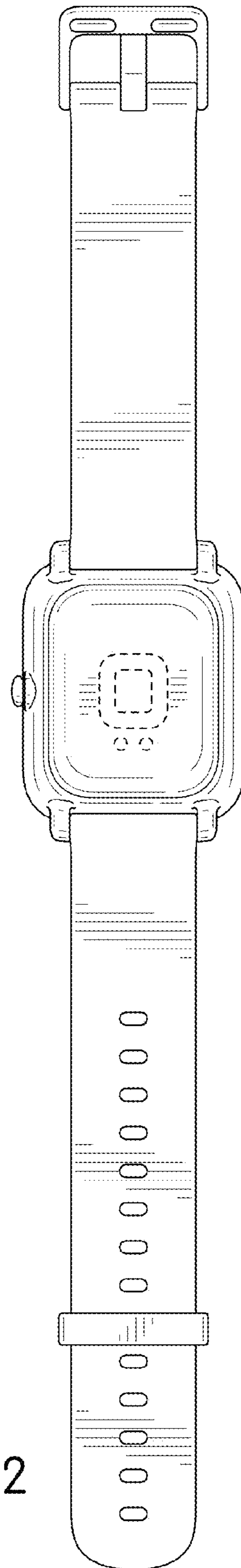

FIG. 2

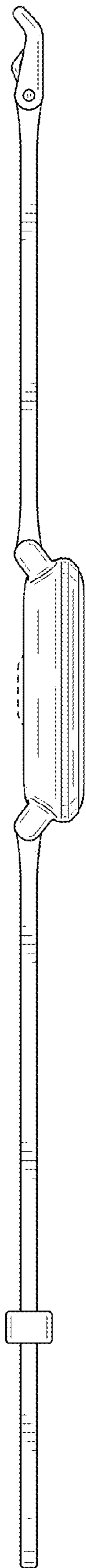

FIG. 3

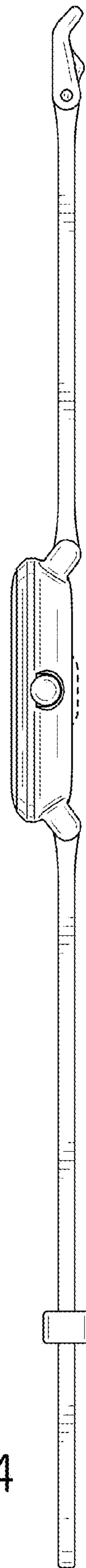

FIG. 4

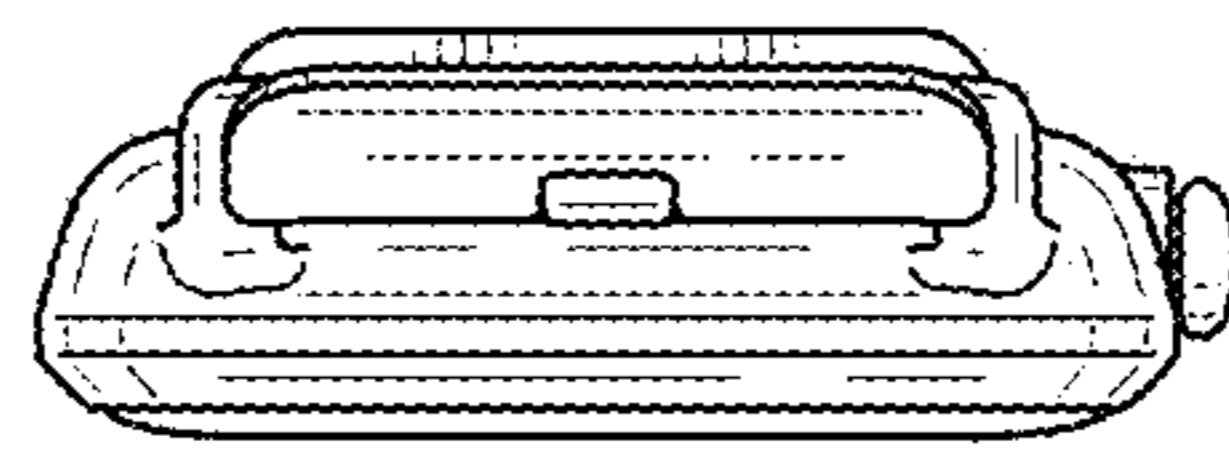

FIG. 5

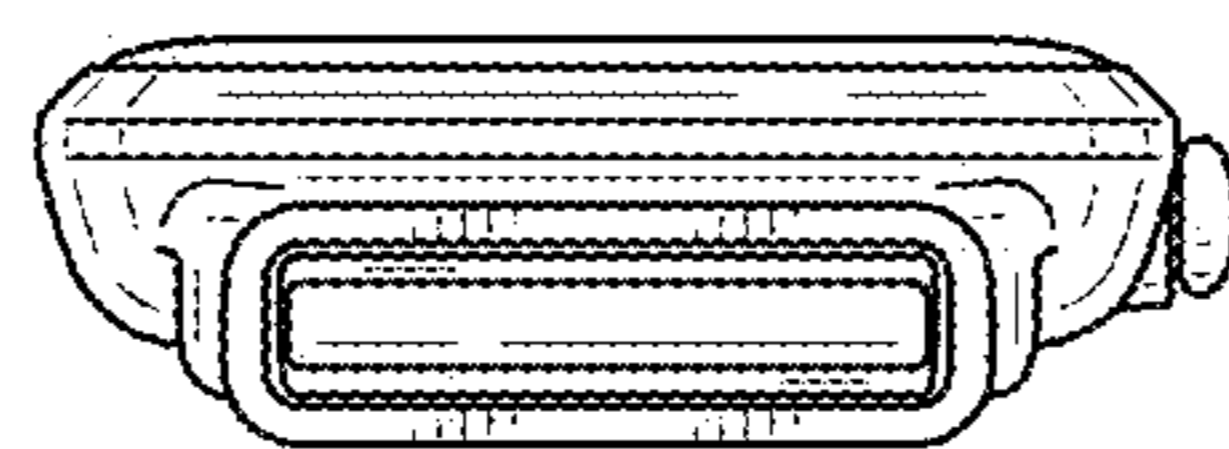

FIG. 6

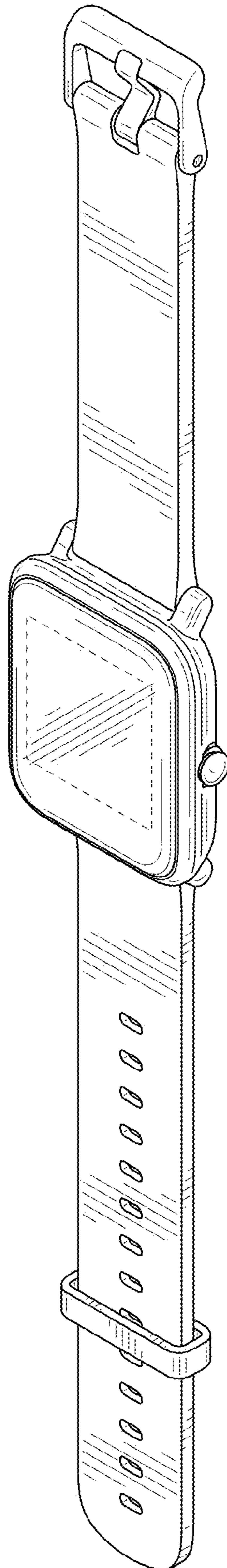

FIG. 7