



US00D876211S

(12) **United States Design Patent**
Wassdahl et al.

(10) **Patent No.:** **US D876,211 S**
(45) **Date of Patent:** **** Feb. 25, 2020**

(54) **FASTENING DEVICE FOR ANTENNA**

(71) Applicant: **MAFI AB**, Mora (SE)

(72) Inventors: **Jonas Wassdahl**, Mora (SE); **Andreas Axelsson**, Malung (SE)

(73) Assignee: **MaFI AB**, Mora (SE)

(**) Term: **15 Years**

(21) Appl. No.: **29/656,982**

(22) Filed: **Jul. 18, 2018**

(30) **Foreign Application Priority Data**

Jan. 26, 2018 (EM) 004681336

(51) **LOC (12) Cl.** **08-08**

(52) **U.S. Cl.**
USPC **D8/382**

(58) **Field of Classification Search**
USPC D8/14, 71, 72, 349, 354, 355, 371, 380,
D8/381, 382, 394, 396, 499; D10/103,
D10/121; D13/133, 149, 154
CPC F16B 2/12; F16B 2/065; F16B 7/00; F16B
7/04; F16B 7/0446; F16B 7/0486; F16L
3/02; F16L 3/10; F16L 3/1016; F16L
3/1091; F16M 13/022; H01Q 1/12; H01Q
1/1207; H01Q 1/1228; H01Q 1/125
See application file for complete search history.

(56) **References Cited**

U.S. PATENT DOCUMENTS

4,616,797 A * 10/1986 Cramer F16B 2/12
24/514
D296,545 S * 7/1988 Sachs D13/149
D296,546 S * 7/1988 Sachs D13/149

D381,113 S * 7/1997 Safyan D13/149
6,283,425 B1 * 9/2001 Liljevik H01Q 1/125
248/218.4
D454,479 S * 3/2002 Kolpin D8/349
D550,540 S * 9/2007 Nawrocki D8/354
D552,947 S * 10/2007 Ewasiuk D8/5
D563,771 S * 3/2008 Prechtel D8/354
D599,193 S * 9/2009 Meyer D8/354
D618,992 S * 7/2010 Rix D8/354
D747,636 S * 1/2016 Maher D8/72
D758,178 S * 6/2016 Kim D8/396
D768,469 S * 10/2016 Bengtsson D8/382
D777,024 S * 1/2017 Lee D8/396
D826,029 S * 8/2018 Granberg D8/349
2012/0026065 A1 * 2/2012 Lo H01Q 1/1228
343/890
2013/0221182 A1 * 8/2013 Renilson H01Q 1/1228
248/534
2017/0122491 A1 * 5/2017 Mancuso F16M 13/02
2017/0288292 A1 * 10/2017 Renilson H01Q 1/1228

* cited by examiner

Primary Examiner — Sandra S Snapp

Assistant Examiner — Ieisha N Price

(74) *Attorney, Agent, or Firm* — Nixon & Vanderhye P.C.

(57) **CLAIM**

The ornamental design for a fastening device for antenna, as shown and described.

DESCRIPTION

FIG. 1 is a perspective view of a fastening device for antenna according to the invention;
FIG. 2 is a front view thereof;
FIG. 3 is a back view thereof;
FIG. 4 is a left side view thereof;
FIG. 5 is a right side view thereof;
FIG. 6 is a top view thereof; and,
FIG. 7 is a bottom view thereof.

1 Claim, 7 Drawing Sheets

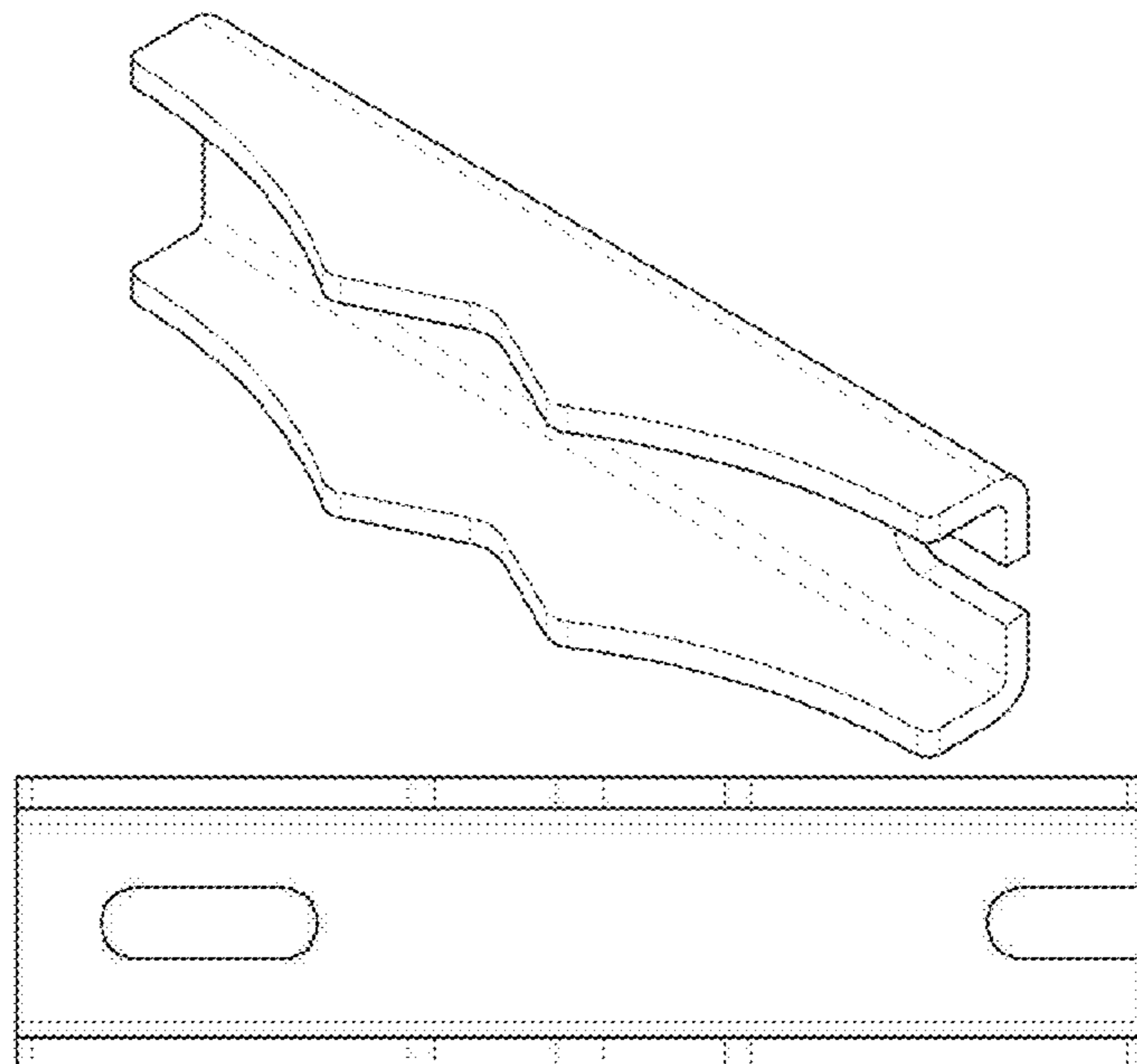

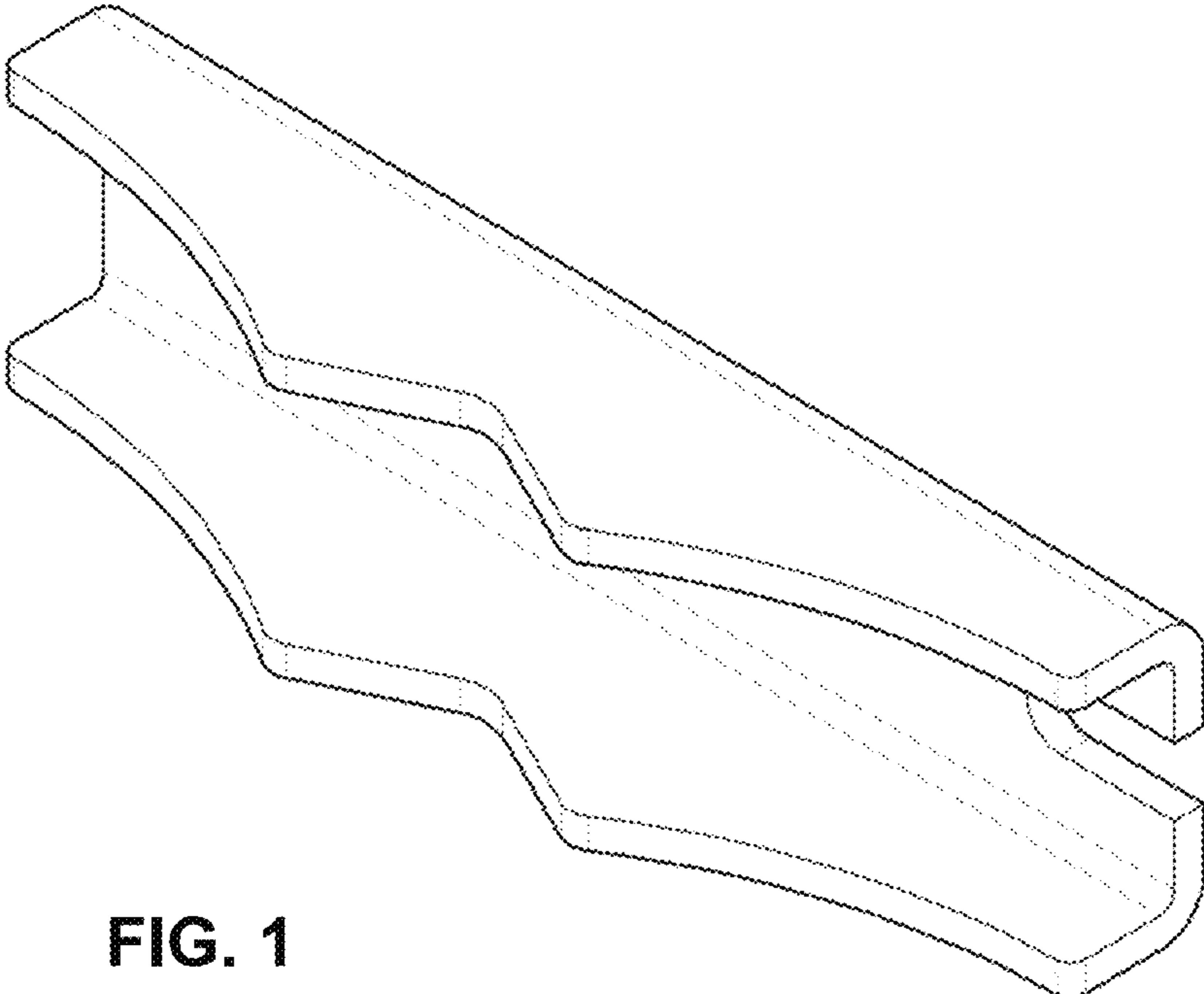

FIG. 1

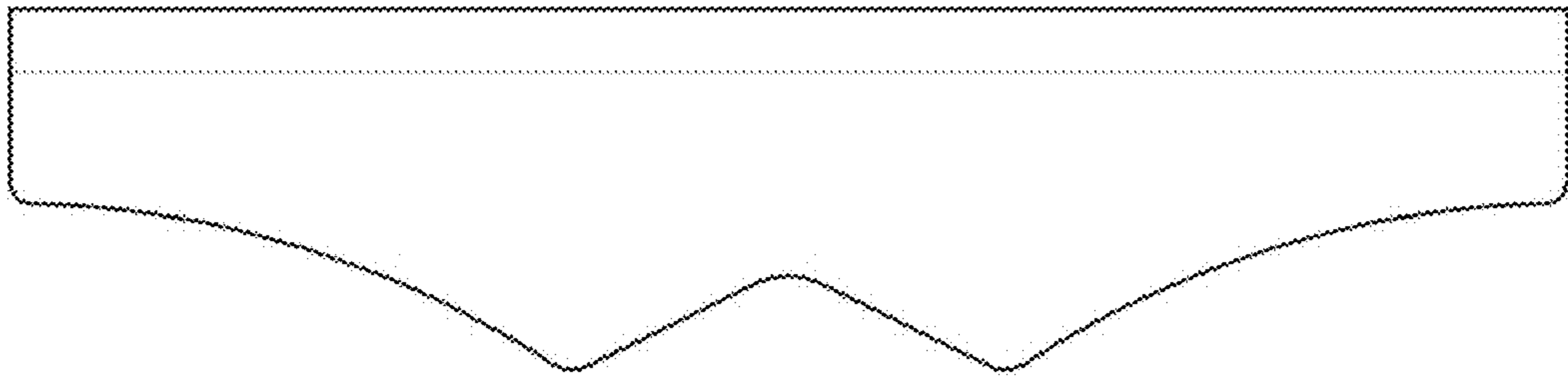

FIG. 2

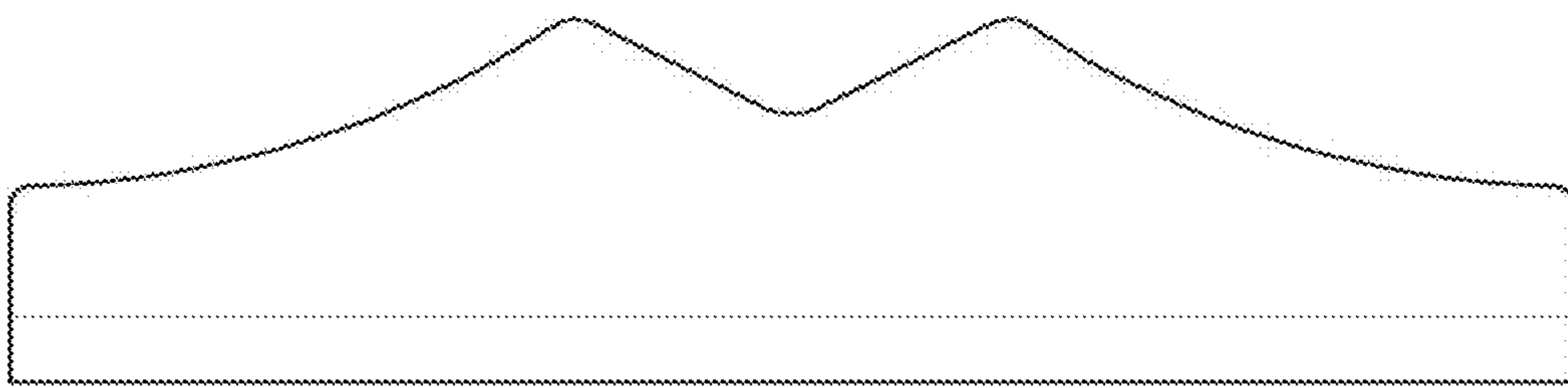

FIG. 3

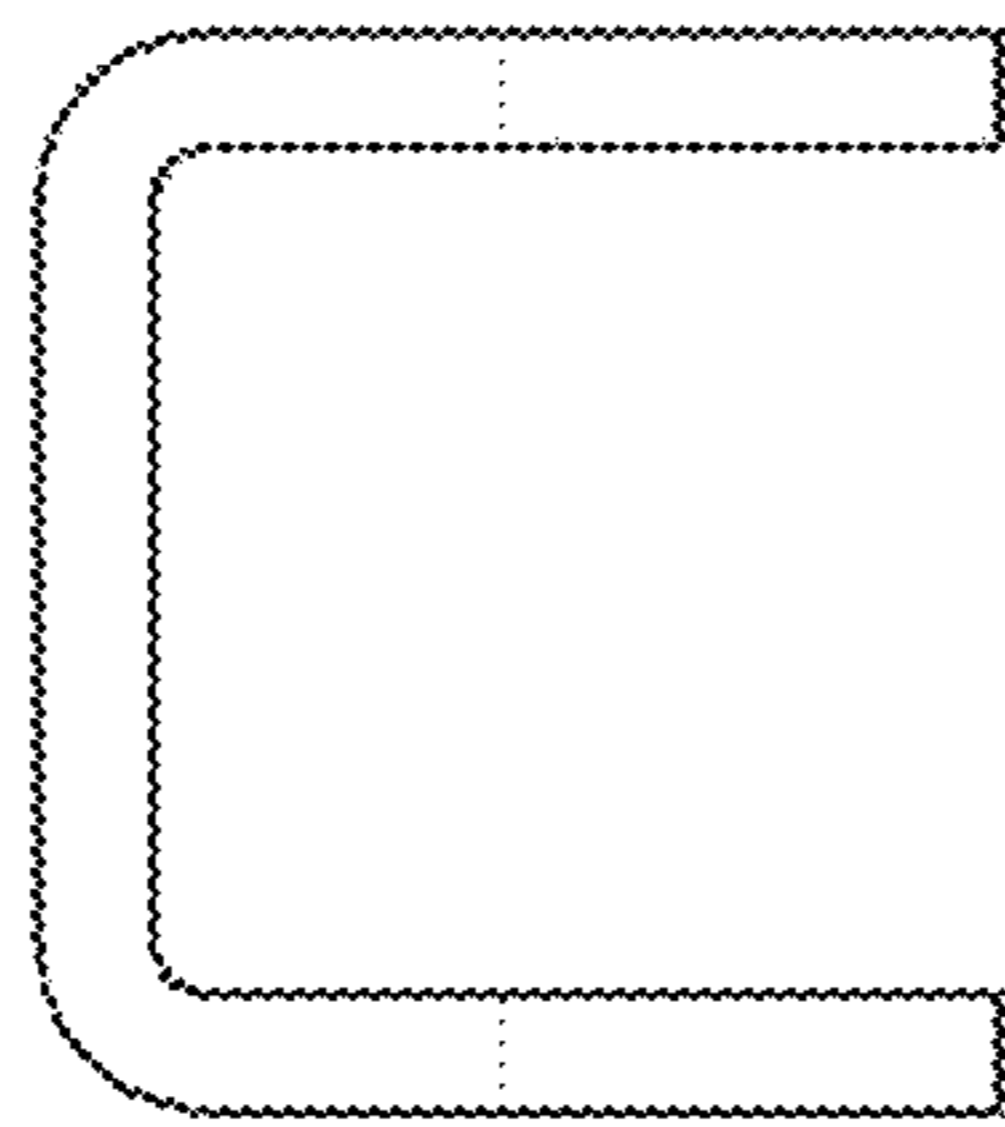

FIG. 4

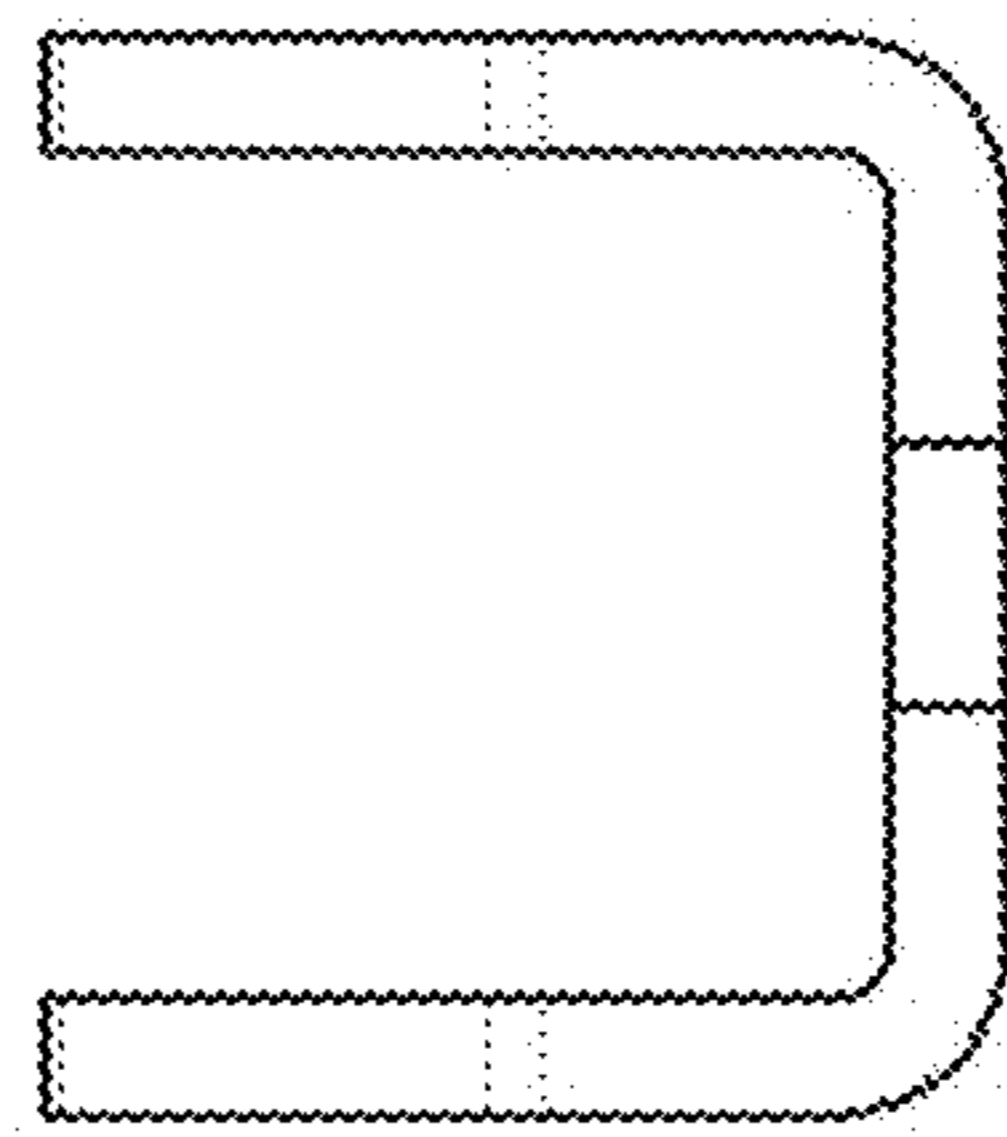

FIG. 5

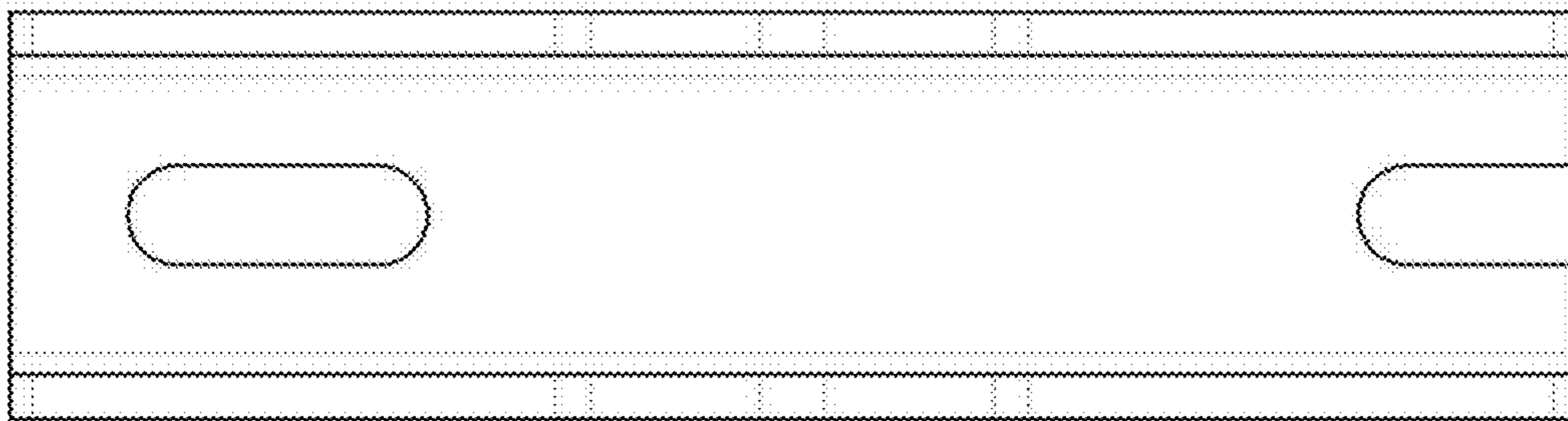

FIG. 6

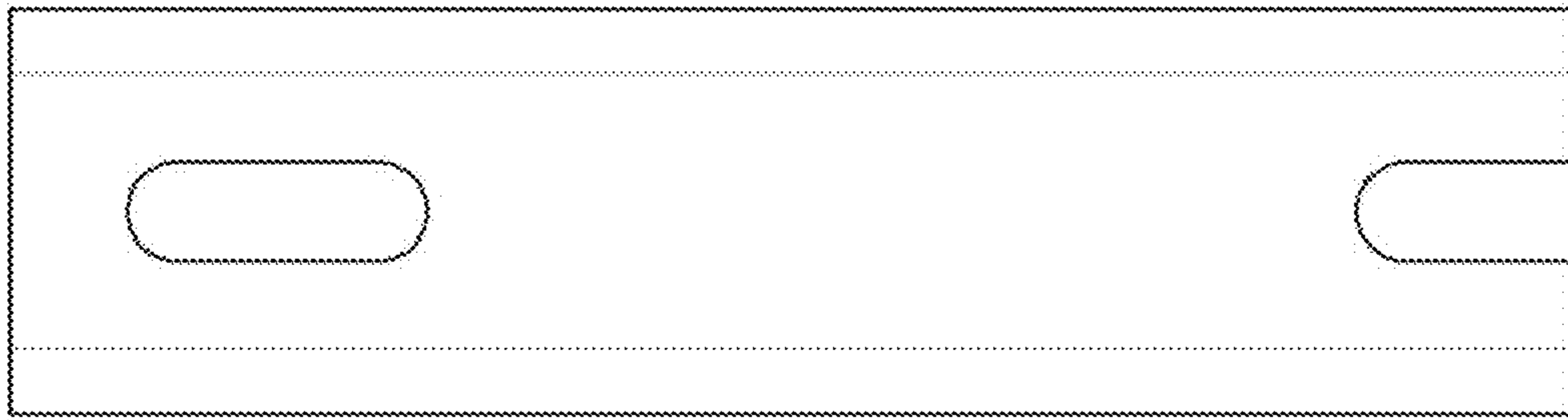

FIG. 7