



US00D876141S

(12) **United States Design Patent** (10) **Patent No.:** **US D876,141 S**  
**Wilson et al.** (45) **Date of Patent:** **\*\* Feb. 25, 2020**

(54) **ARTICLE OF FURNITURE**

(71) Applicant: **King Furniture Australia Pty Ltd.,**  
Turrella (AU)

(72) Inventors: **Charles Wilson,** Turrella (AU);  
**Bradley Saywell,** Turrella (AU); **Tanya**  
**Rechberger,** Turrella (AU)

(73) Assignee: **King Furniture Australia Pty Ltd.,**  
Turrella (AU)

(\*\*) Term: **15 Years**

(21) Appl. No.: **29/628,179**

(22) Filed: **Dec. 1, 2017**

(30) **Foreign Application Priority Data**

Jun. 1, 2017	(AU)	.....	201713256
Jun. 1, 2017	(AU)	.....	201713268

(Continued)

(51) **LOC (12) Cl.** ..... **06-01**

(52) **U.S. Cl.**  
USPC ..... **D6/716.4**

(58) **Field of Classification Search**  
USPC ..... D6/334-336, 371, 372, 374, 375, 377,  
D6/381, 716, 716.1, 716.2, 716.4, 601  
(Continued)

(56) **References Cited**

U.S. PATENT DOCUMENTS

D356,448 S	*	3/1995	Kashima	.....	D6/335
D518,305 S	*	4/2006	Lewis	.....	D6/381

(Continued)

Primary Examiner — Mimoso De

(74) *Attorney, Agent, or Firm* — Banner & Witcoff, Ltd.

(57) **CLAIM**

The ornamental design for an article of furniture, as shown and described.

**DESCRIPTION**

FIG. 1 is a front perspective view of an article of furniture showing our new design;  
 FIG. 2 is a top view thereof;  
 FIG. 3 is a left side view thereof;  
 FIG. 4 is a front view thereof;  
 FIG. 5 is a right side view thereof;  
 FIG. 6 is a rear view thereof;  
 FIG. 7 is a bottom view thereof;  
 FIG. 8 is a front perspective view of the article of furniture shown in FIGS. 1-7 shown in an example environment;  
 FIG. 9 is a top view thereof;  
 FIG. 10 is a front view thereof;  
 FIG. 11 is a right side view thereof;  
 FIG. 12 is a rear view thereof;  
 FIG. 13 is a front perspective view of alternative embodiment of an article of furniture showing our new design;  
 FIG. 14 is a top view thereof;  
 FIG. 15 is a left side view thereof;  
 FIG. 16 is a front view thereof;  
 FIG. 17 is a right side view thereof;  
 FIG. 18 is a rear view thereof;  
 FIG. 19 is a bottom view thereof;  
 FIG. 20 is a front perspective view of the article of furniture shown in FIGS. 13-19 shown in an example environment;  
 FIG. 21 is a top view thereof;  
 FIG. 22 is a left side view thereof;  
 FIG. 23 is a front view thereof; and,  
 FIG. 24 is a rear view thereof.  
 The broken lines showing the remainder of the article of furniture in FIGS. 8-12 and FIGS. 20-24 represent environmental subject matter only and form no part of the claimed design.

**1 Claim, 4 Drawing Sheets**

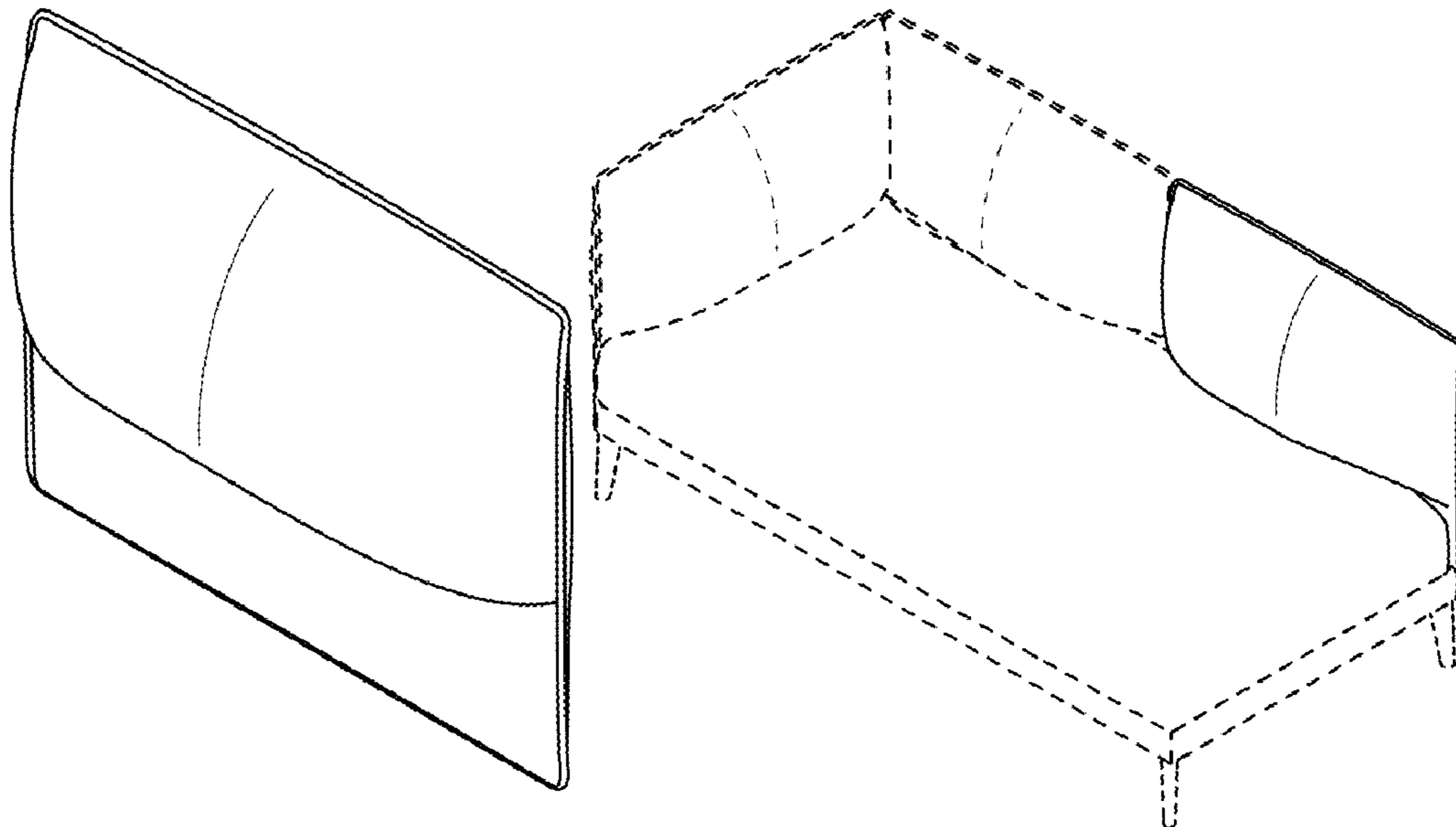

(30) **Foreign Application Priority Data**

Jun. 1, 2017 (AU) ..... 201713275  
Jun. 1, 2017 (AU) ..... 201713276

(58) **Field of Classification Search**

CPC ..... A47C 7/021; A47C 13/005; A47C 17/132;  
A47C 7/18; A47C 7/24; A47C 17/00;  
A47C 17/02; A47C 17/04; A47C 17/045;  
A47C 17/14

See application file for complete search history.

(56) **References Cited**

U.S. PATENT DOCUMENTS

D521,269 S \* 5/2006 Natuzzi ..... D6/381  
D541,074 S \* 4/2007 Natuzzi ..... D6/381  
D544,244 S \* 6/2007 Ricci ..... D6/381  
D691,386 S \* 10/2013 Bosman ..... D6/371  
D699,460 S \* 2/2014 Bosman ..... D6/371  
D738,641 S \* 9/2015 Adair ..... D6/381  
D802,956 S \* 11/2017 Neil ..... D6/372  
D816,366 S \* 5/2018 King ..... D6/381  
D846,932 S \* 4/2019 Lampela ..... D6/716.4  
D849,441 S \* 5/2019 King ..... D6/381  
D851,419 S \* 6/2019 King ..... D6/381

\* cited by examiner

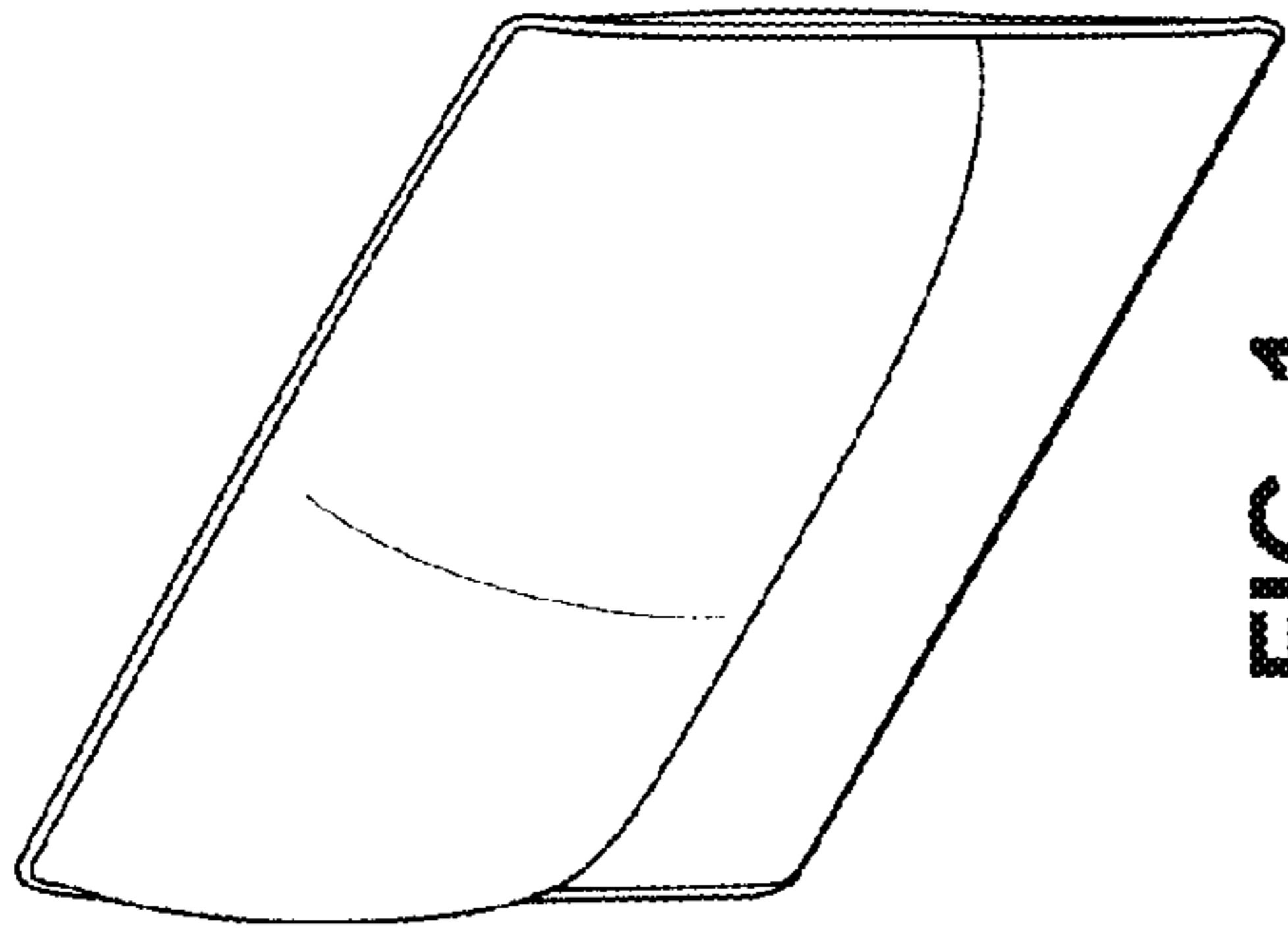

FIG. 1

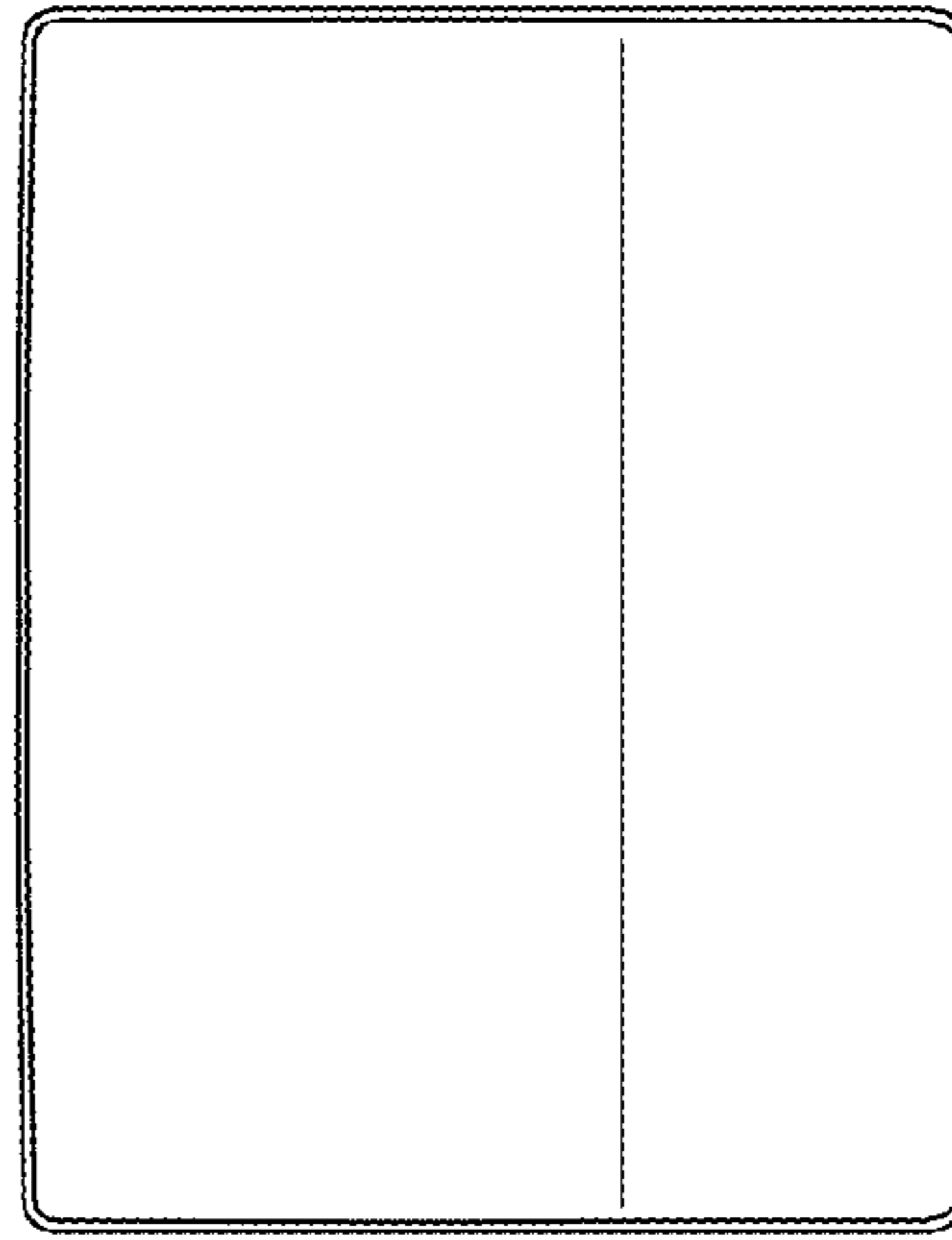

FIG. 6

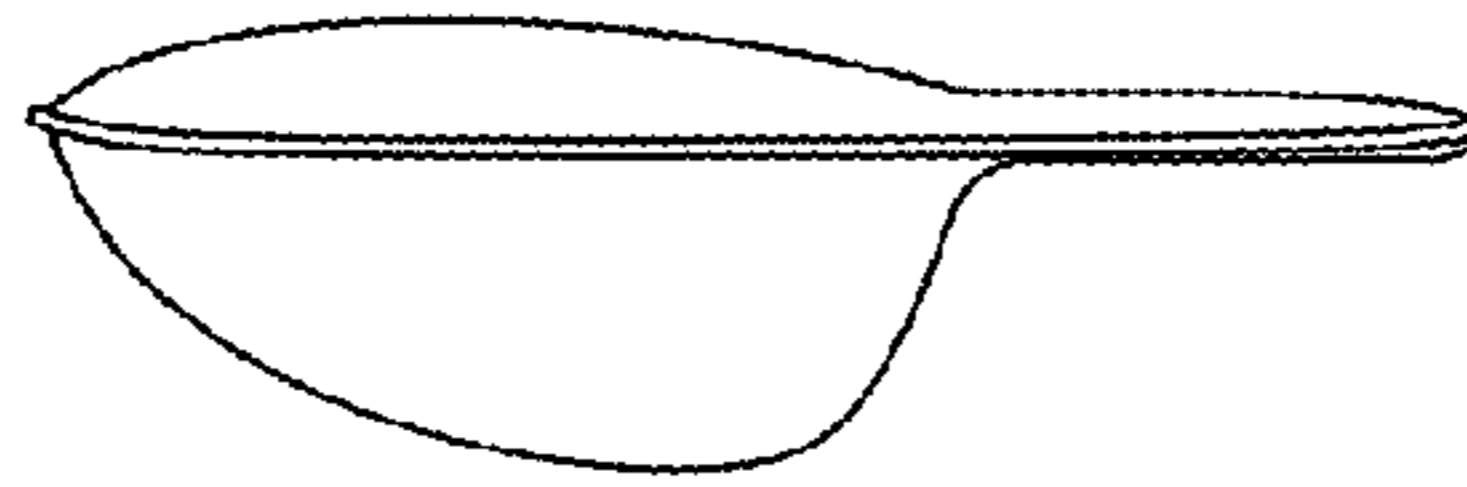

FIG. 5

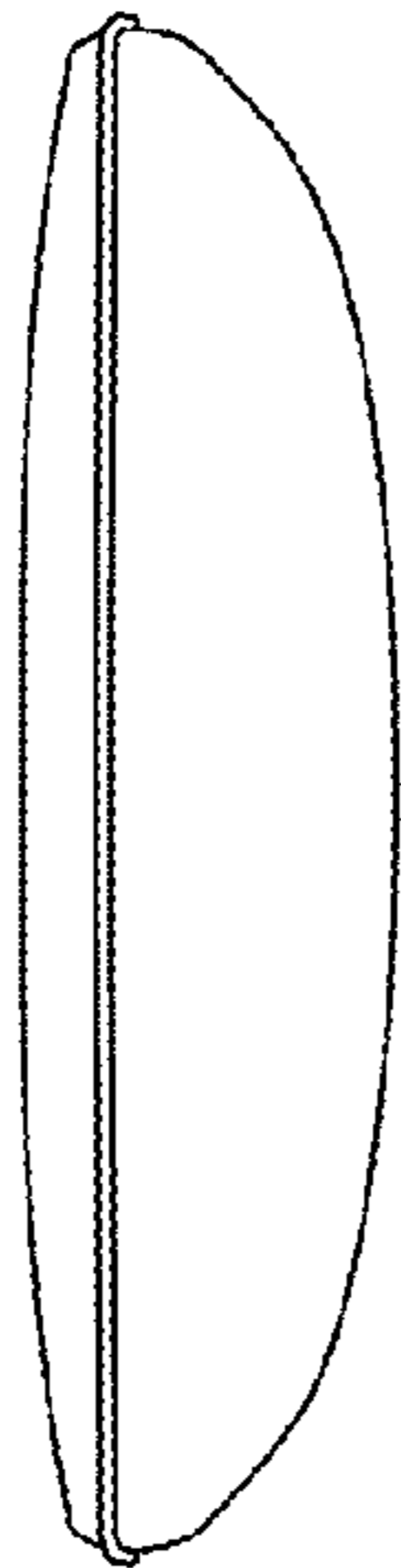

FIG. 2

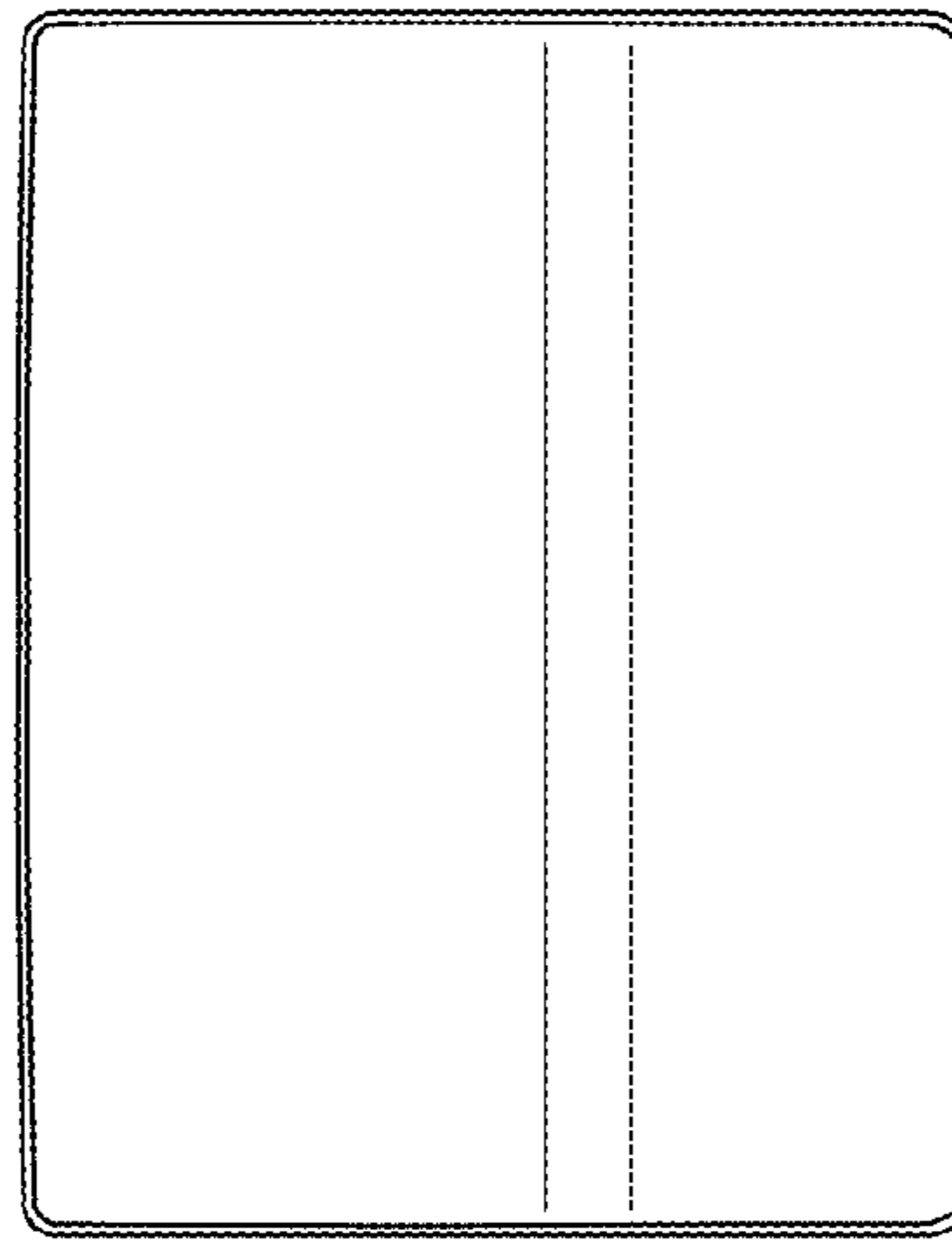

FIG. 4

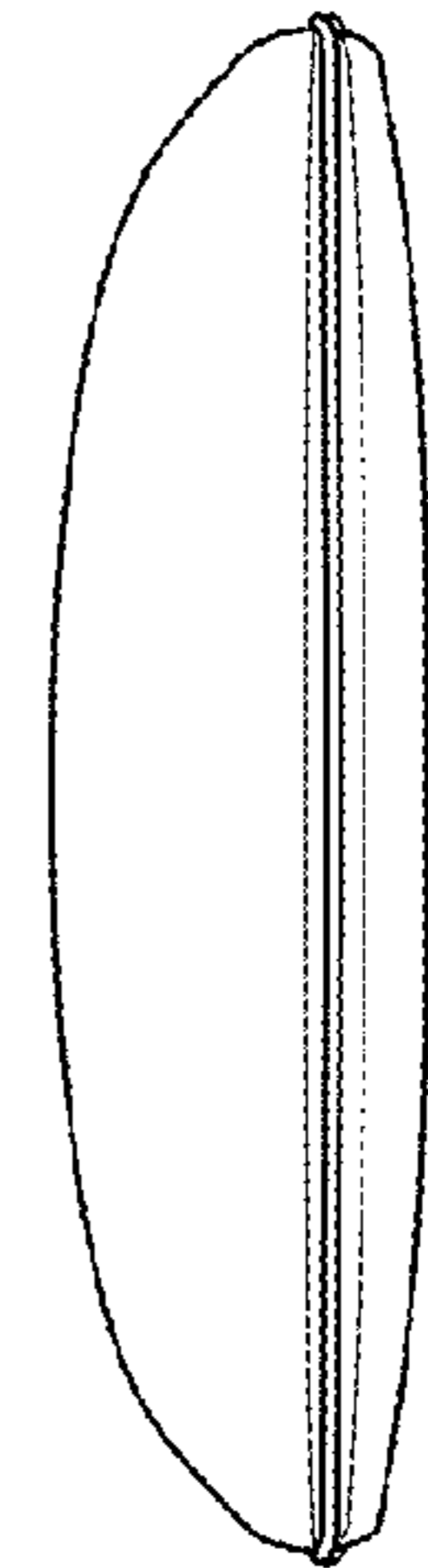

FIG. 7



FIG. 3

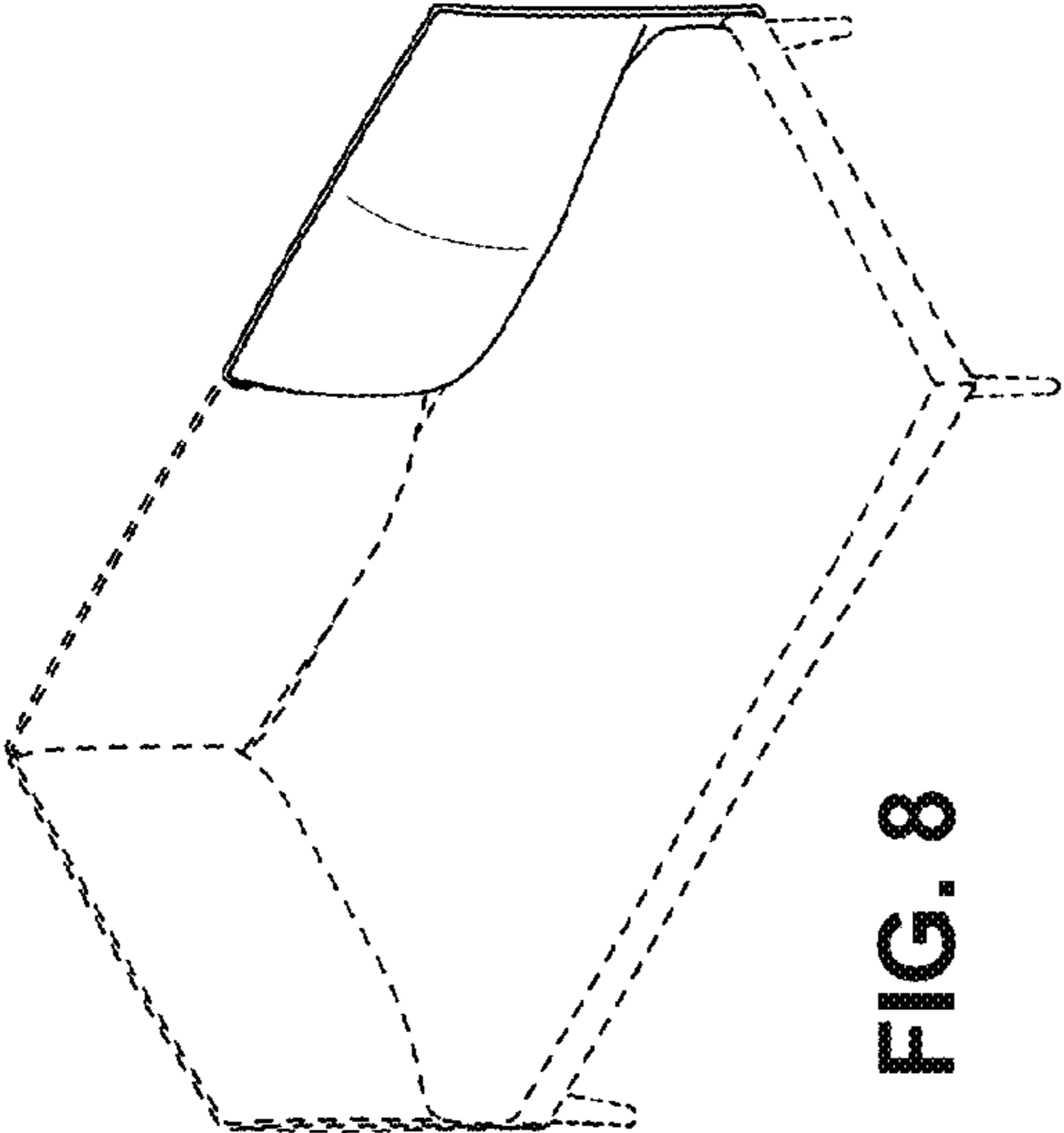

FIG. 8

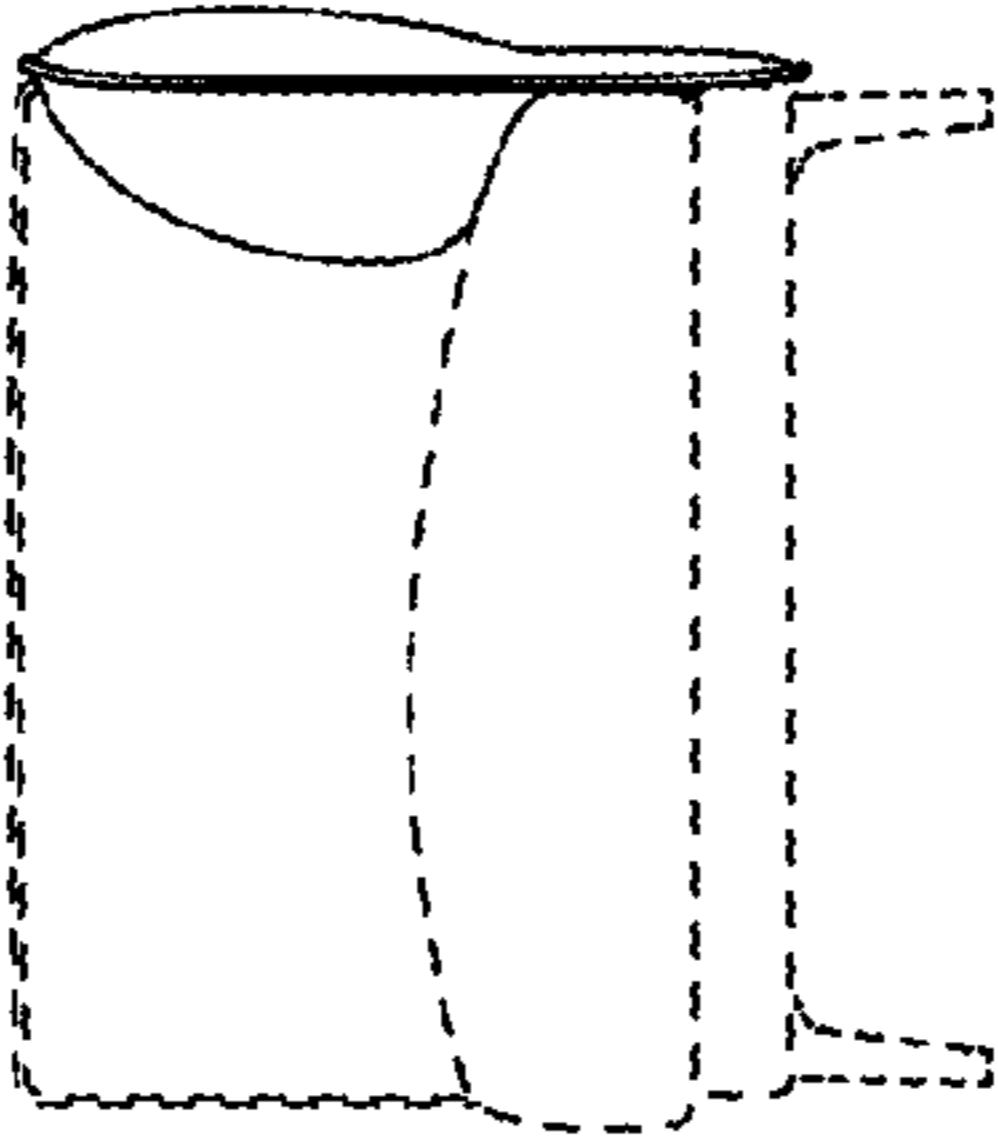

FIG. 11

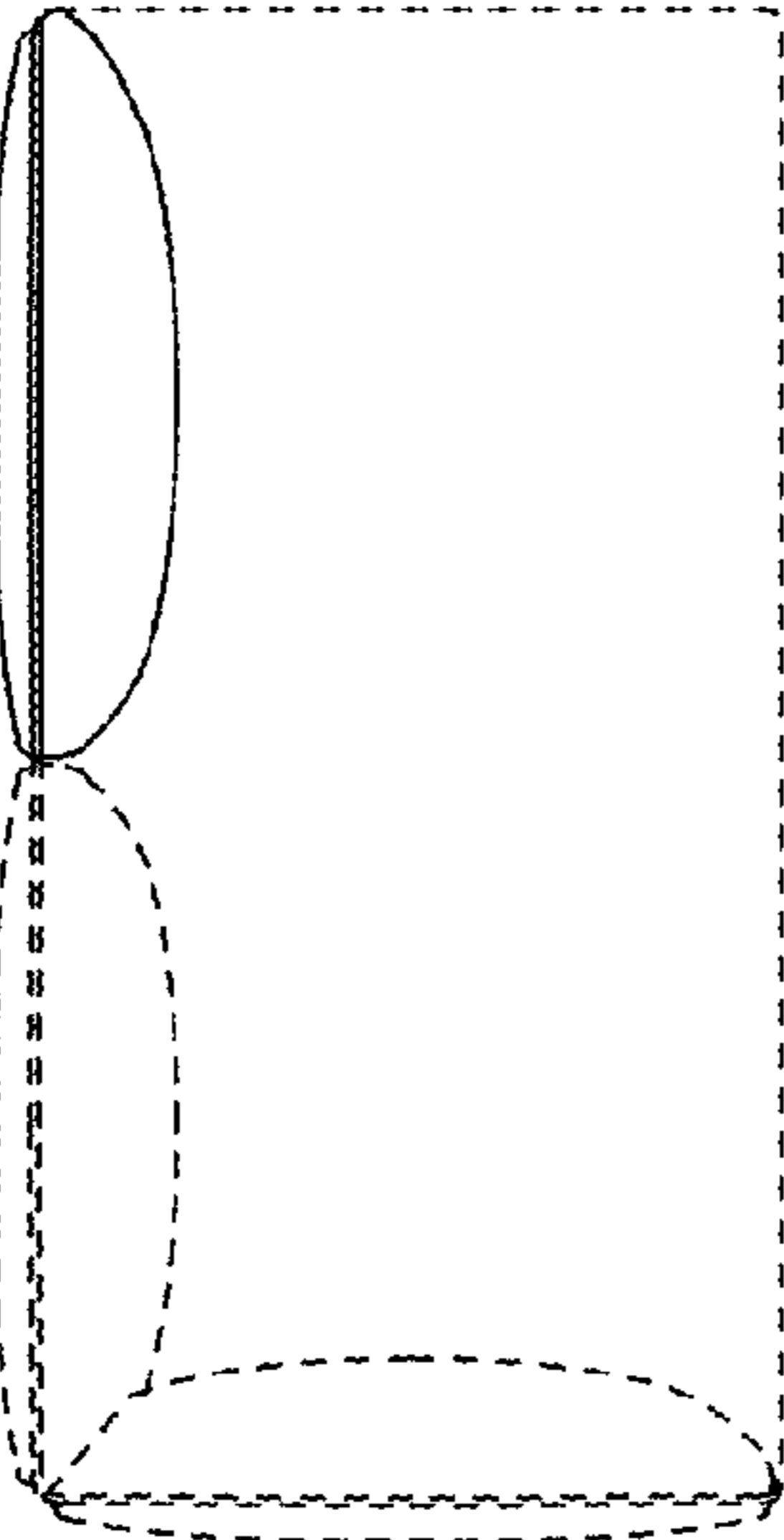

FIG. 9

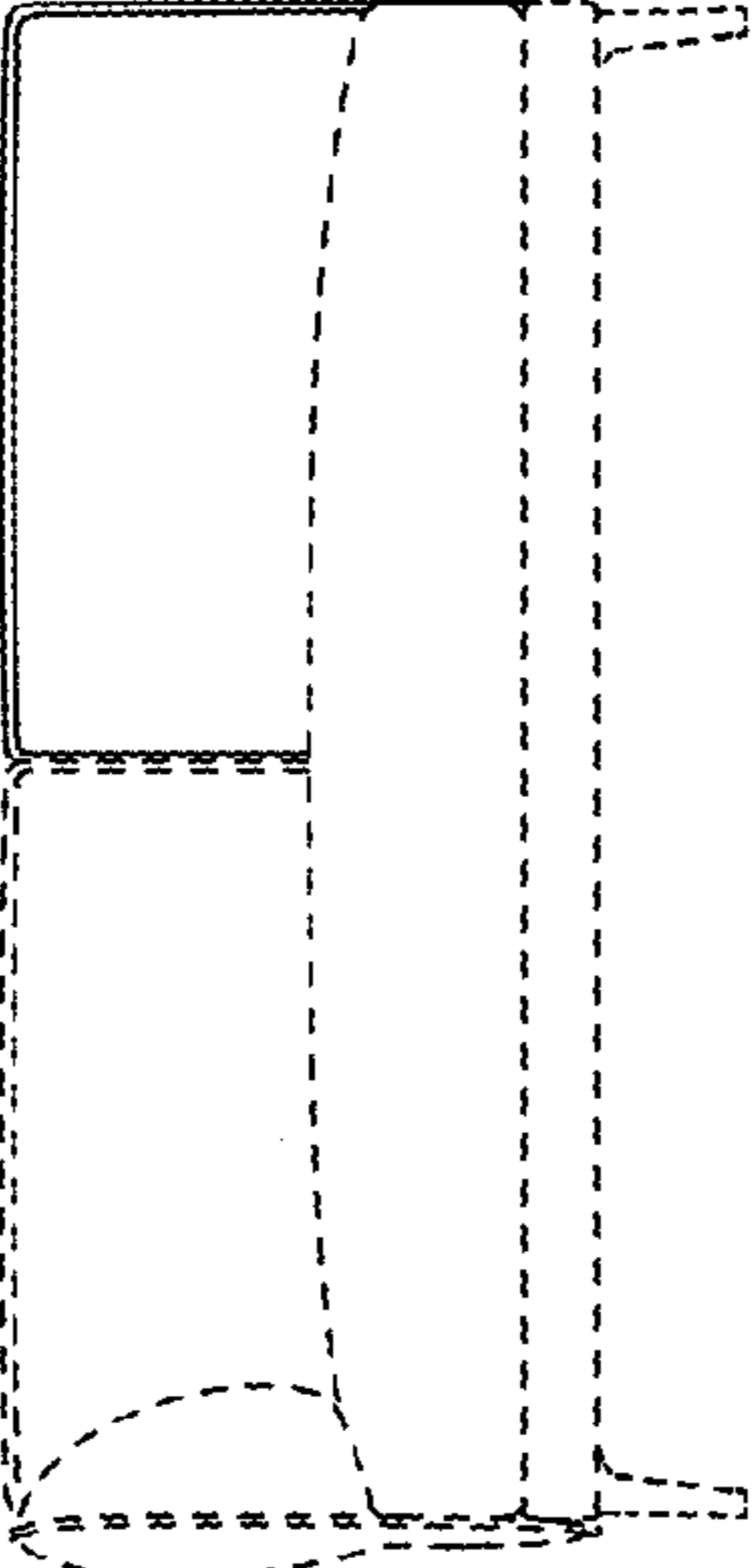

FIG. 10

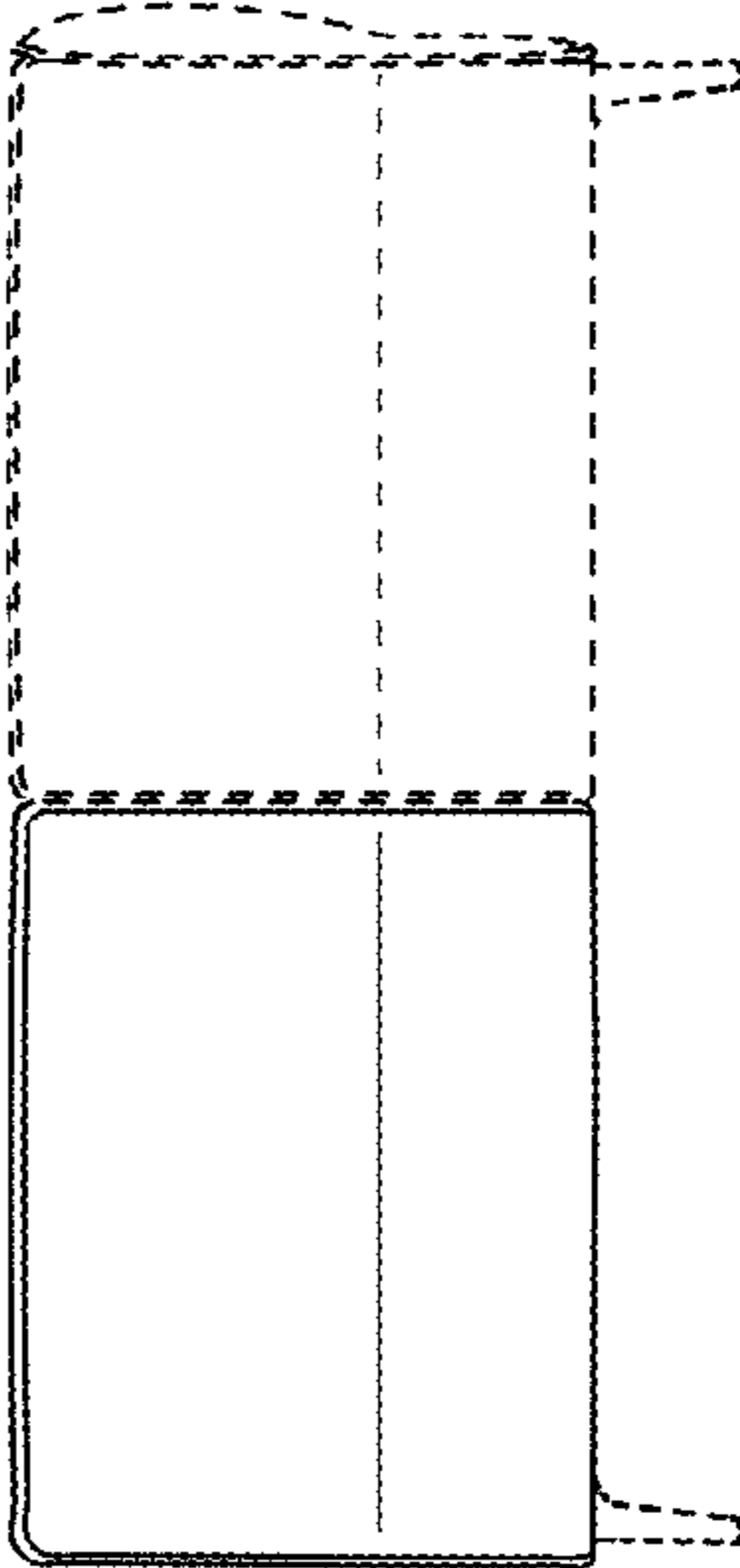

FIG. 12

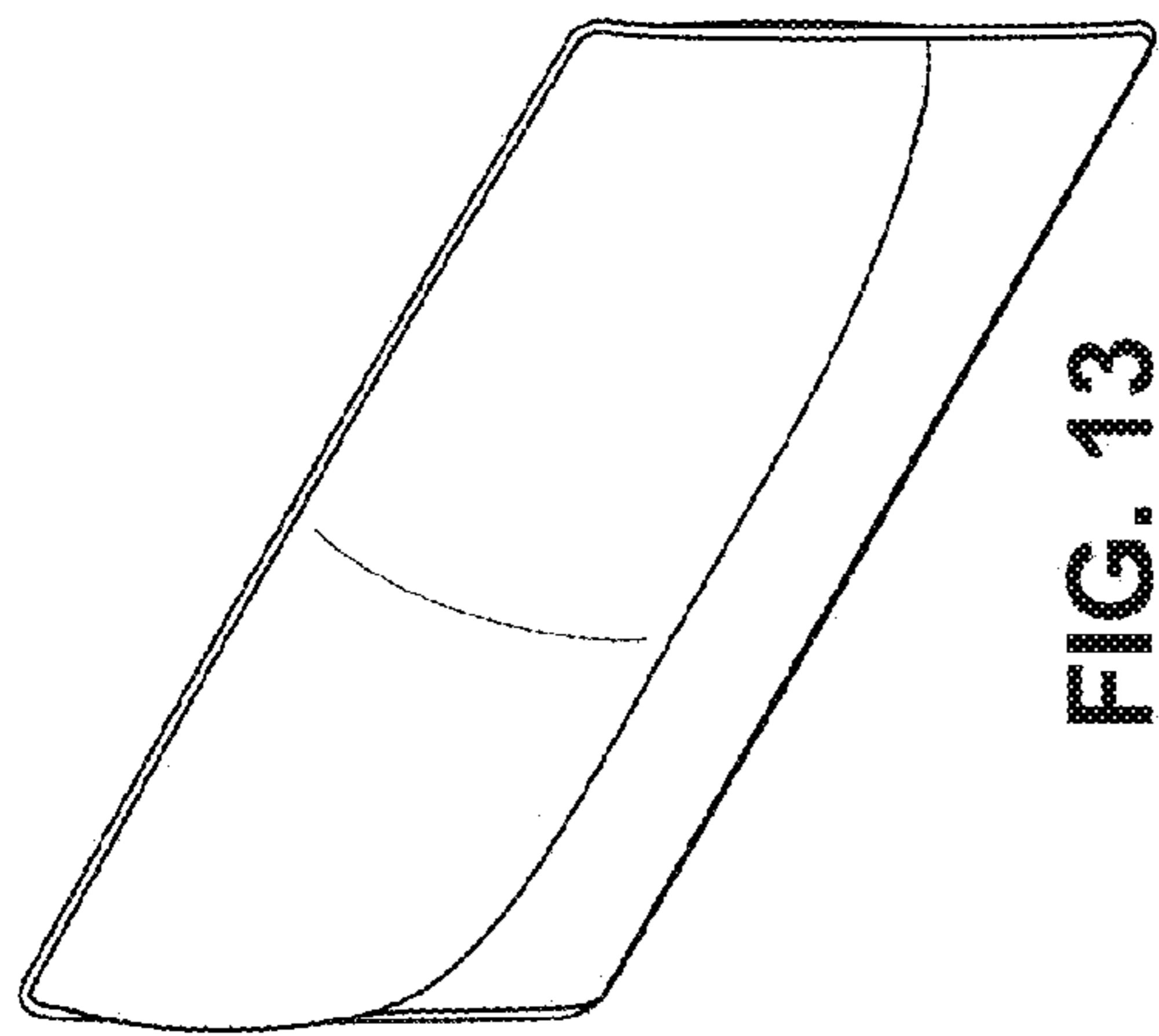

FIG. 13

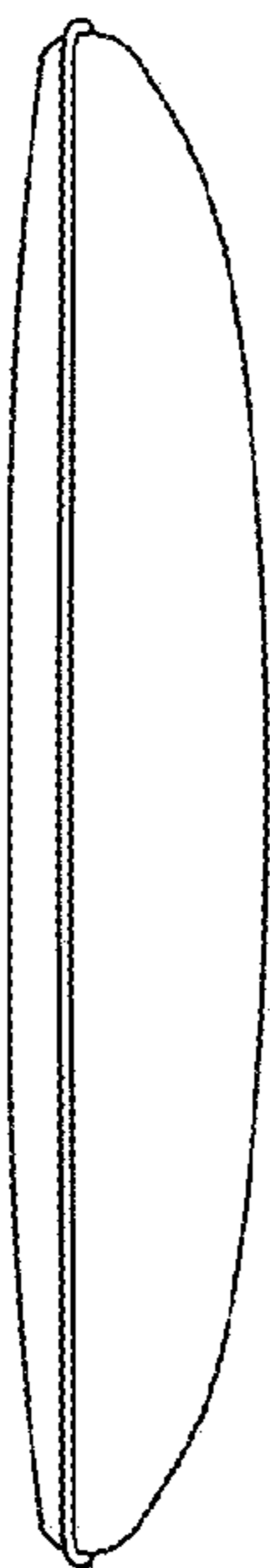

FIG. 14

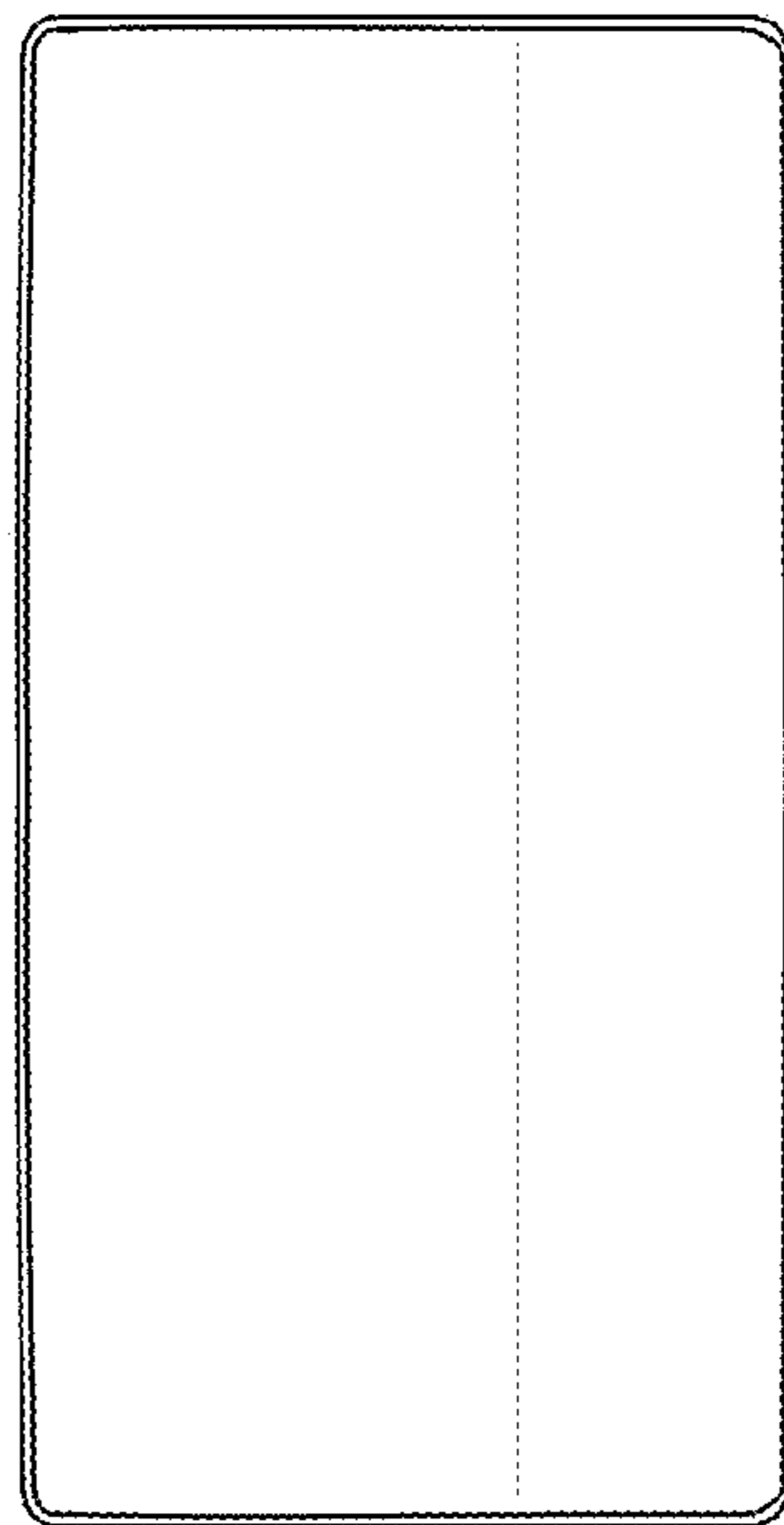

FIG. 17

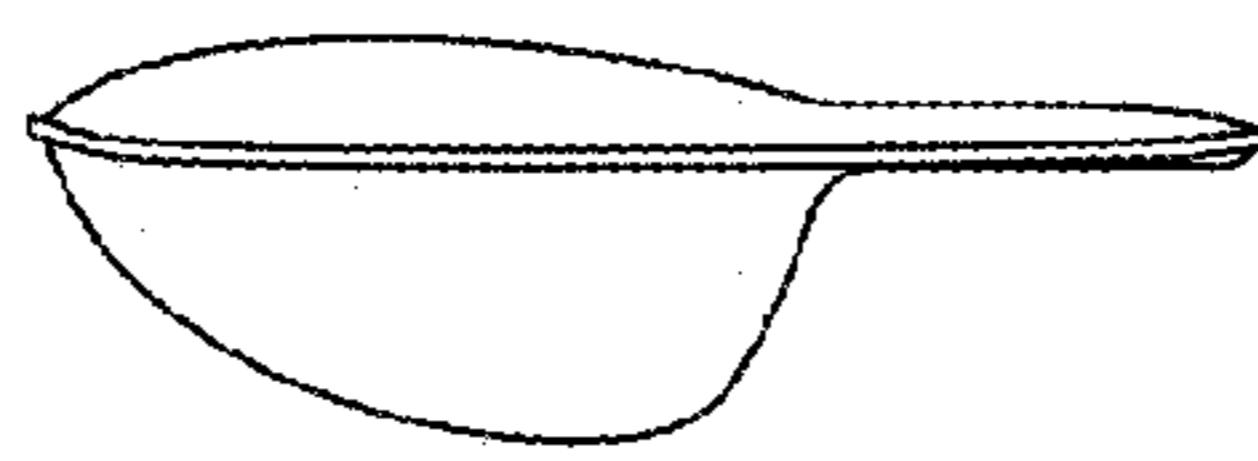

FIG. 18

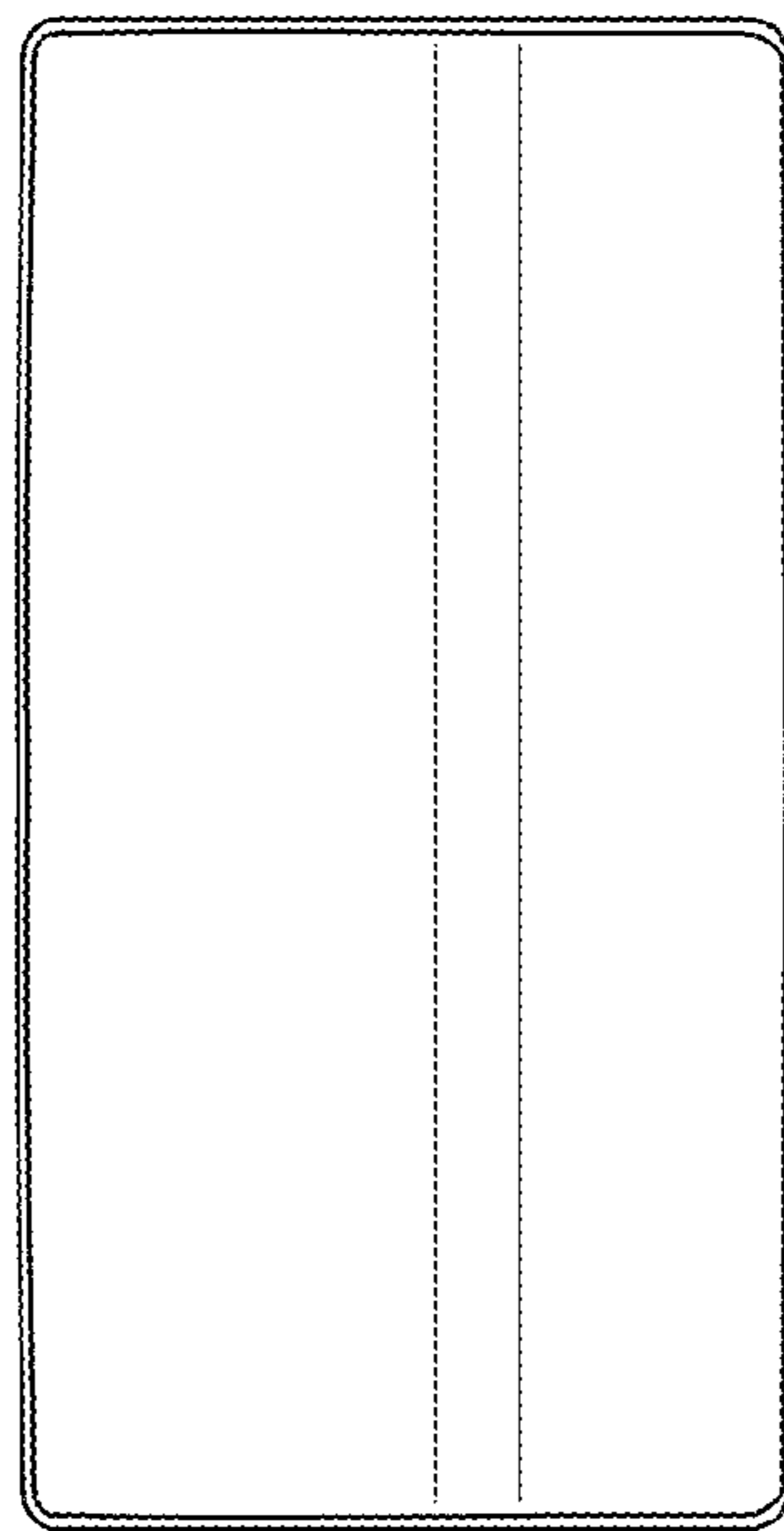

FIG. 15



FIG. 16

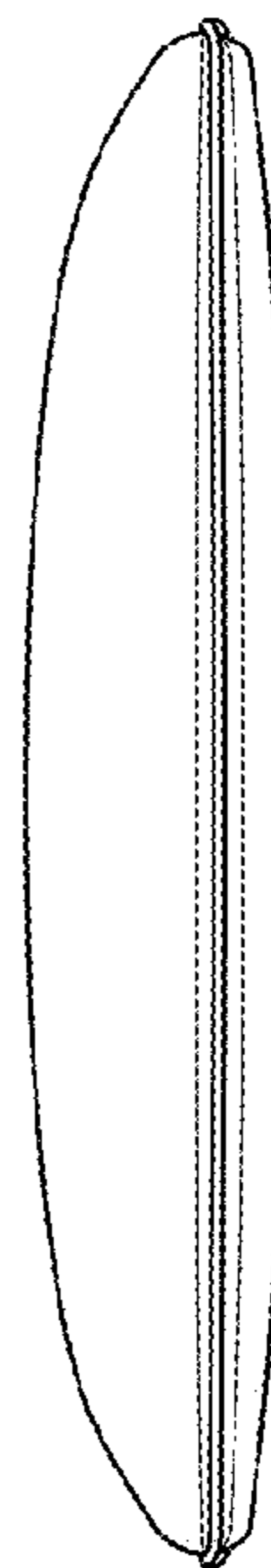

FIG. 19

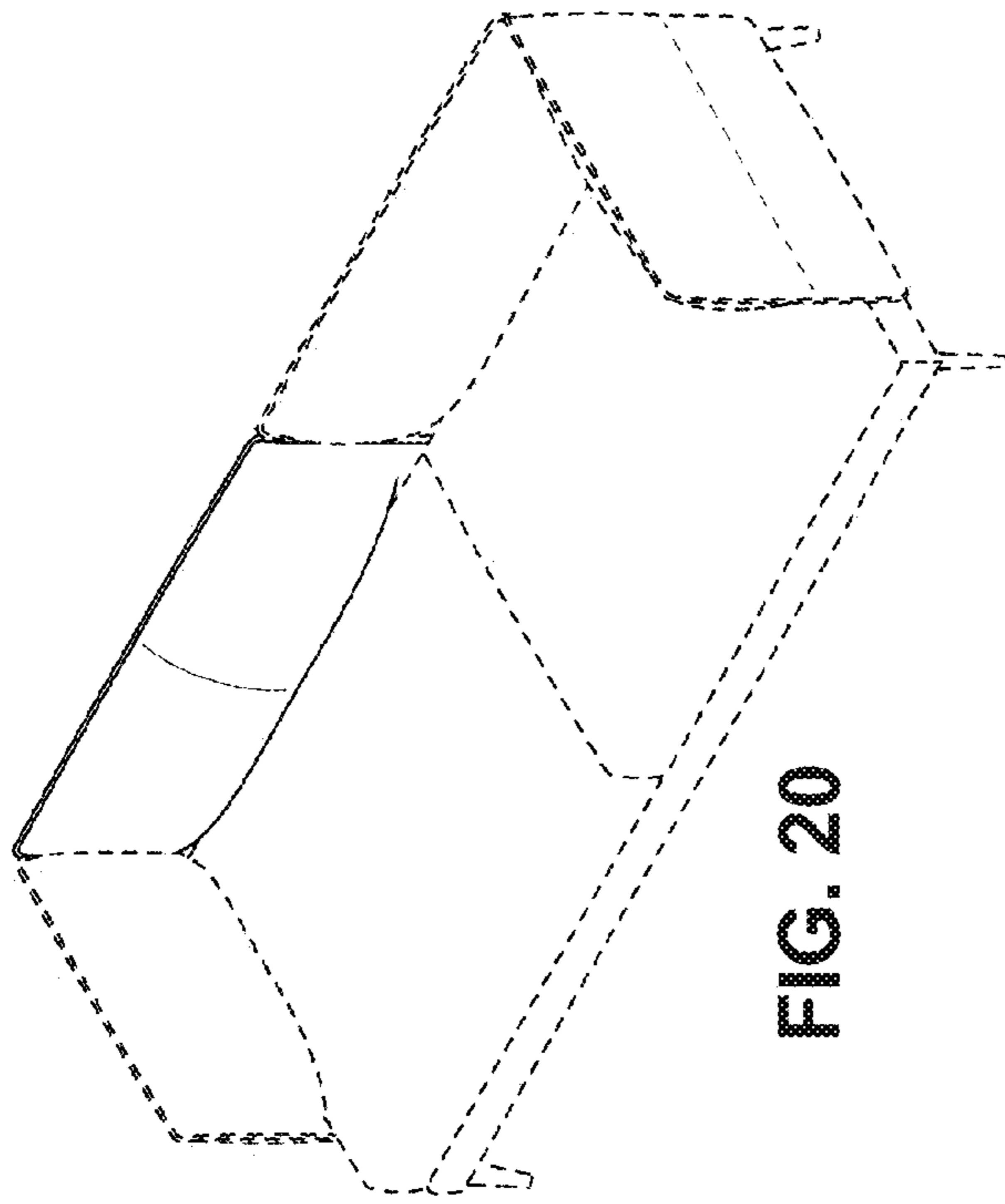

FIG. 20

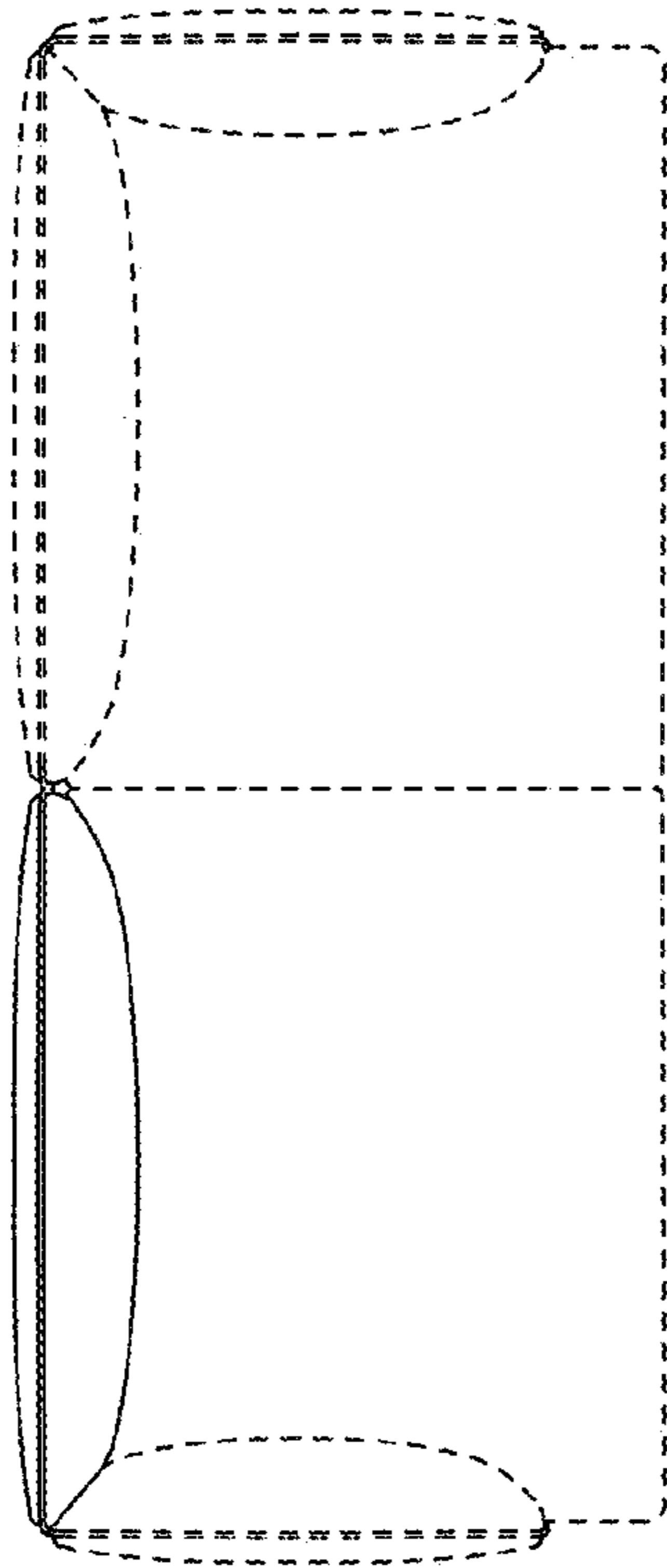

FIG. 21

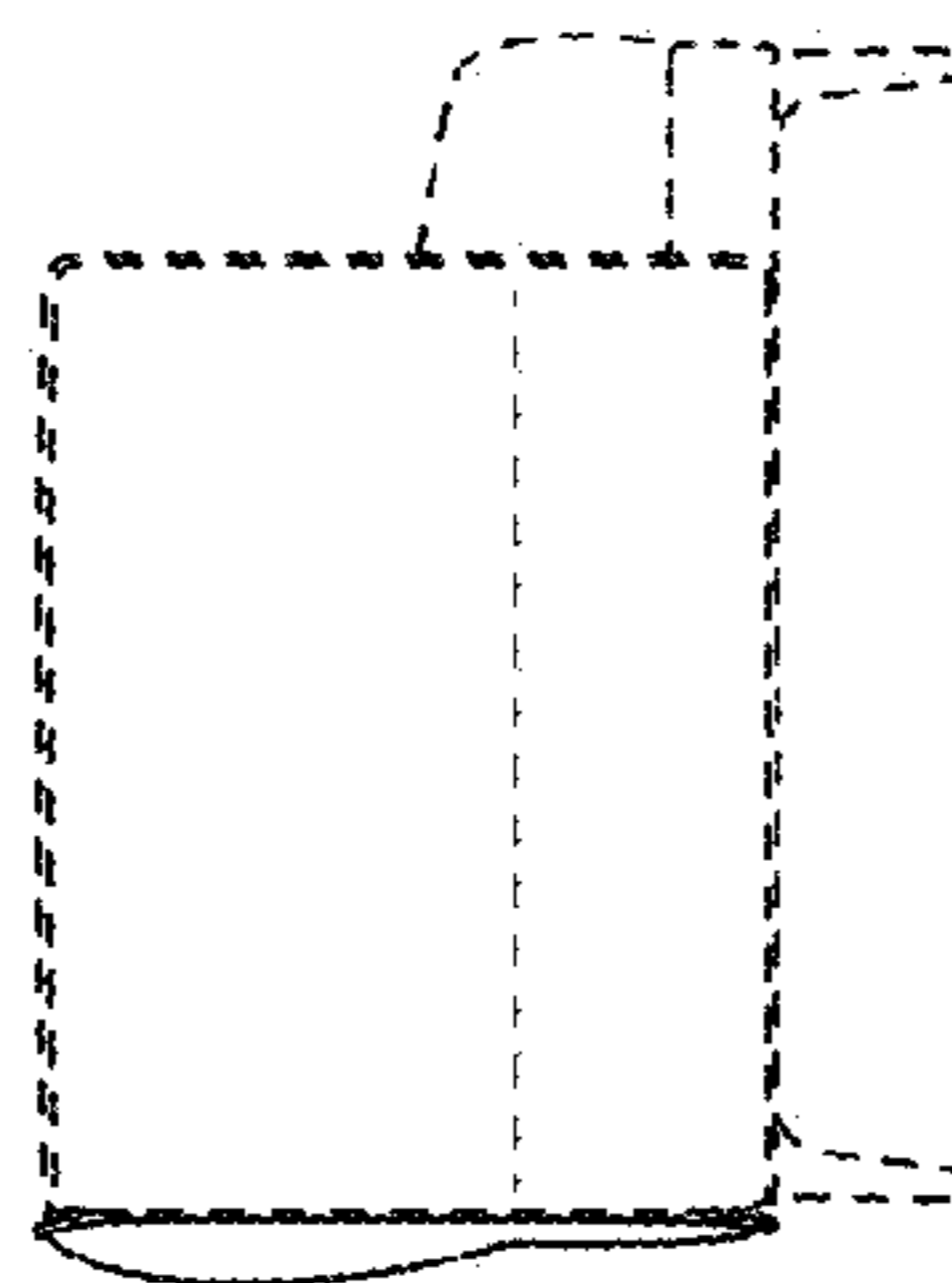

FIG. 22

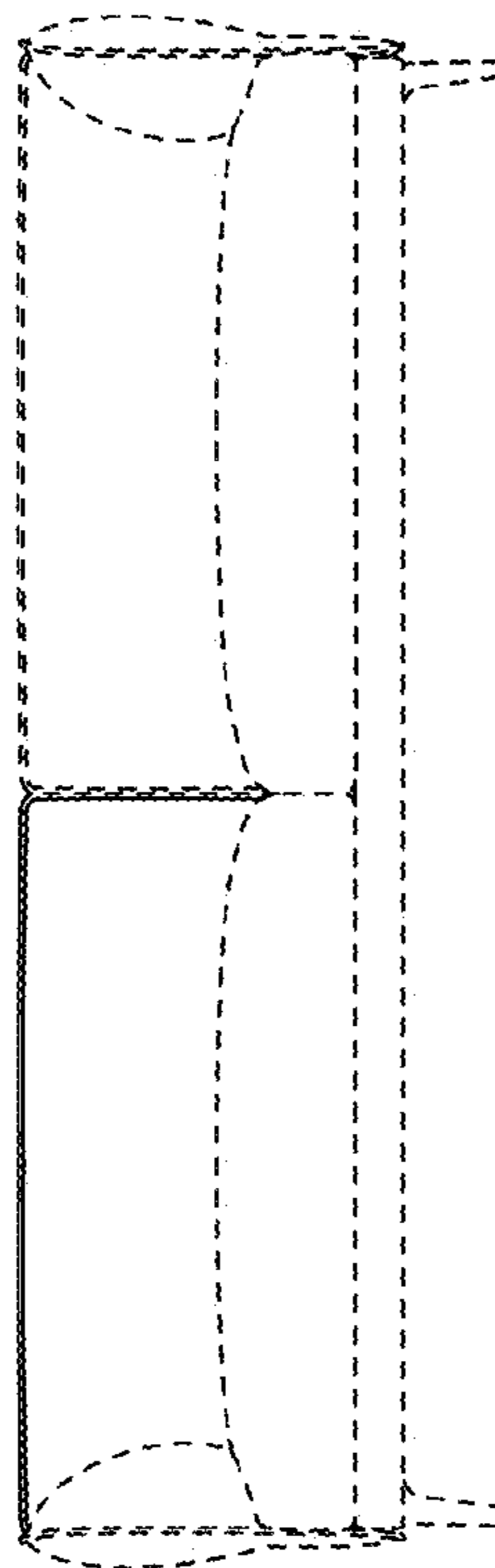

FIG. 23

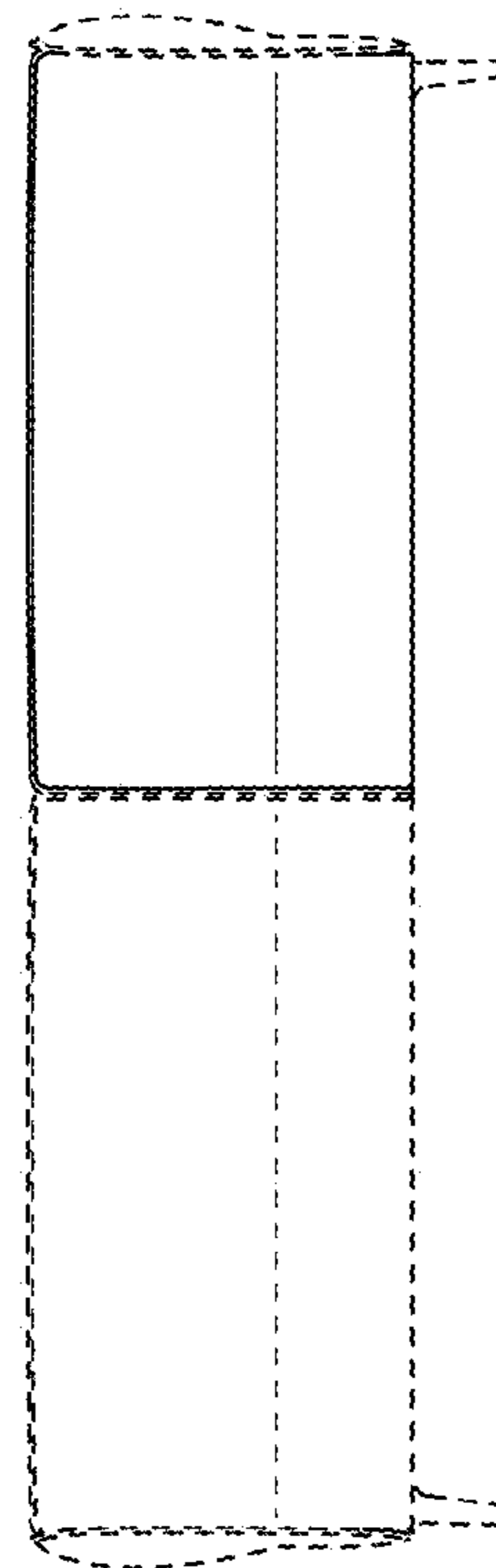

FIG. 24