



US00D876088S

(12) **United States Design Patent**
Galanti

(10) **Patent No.:** **US D876,088 S**

(45) **Date of Patent:** **** Feb. 25, 2020**

(54) **HANDBAG**

(71) Applicant: **J. Choo Limited**, London (GB)

(72) Inventor: **Carolina Galanti**, London (GB)

(73) Assignee: **J. Choo Limited**, London (GB)

(**) Term: **15 Years**

(21) Appl. No.: **29/668,380**

(22) Filed: **Oct. 30, 2018**

(30) **Foreign Application Priority Data**

Jun. 4, 2018 (EM) 005296514-0002

(51) **LOC (12) Cl.** **03-01**

(52) **U.S. Cl.**

USPC **D3/243**

(58) **Field of Classification Search**

USPC D3/232-233, 240-243, 245-246

CPC A45C 1/024; A45C 3/06

See application file for complete search history.

(56) **References Cited**

U.S. PATENT DOCUMENTS

D110,184 S 6/1938 Lobel
D597,305 S 8/2009 Gonzalez

D648,120 S 11/2011 Gonzalez
D689,691 S 9/2013 Kuster
D756,636 S 5/2016 Hannon
D809,788 S * 2/2018 Fusi D3/243
D815,431 S * 4/2018 Fusi D3/243
D820,588 S * 6/2018 Nair D3/243
D834,311 S * 11/2018 Tomasetta D3/243

* cited by examiner

Primary Examiner — Holly H Baynham

(74) *Attorney, Agent, or Firm* — Fross Zelnick Lehrman & Zissu, P.C.; Lawrence E. Apolzon, Esq.

(57) **CLAIM**

The ornamental design for a handbag, as shown and described.

DESCRIPTION

FIG. 1 is a front perspective view of a handbag showing my new design;

FIG. 2 is a right side view thereof;

FIG. 3 is a left side view thereof;

FIG. 4 is a front view thereof;

FIG. 5 is a back view thereof;

FIG. 6 is a top view thereof; and,

FIG. 7 is a bottom view thereof.

The broken line showing of portions of the body of the bag in the drawings are for illustrative purposes only and shows unclaimed subject matter.

1 Claim, 5 Drawing Sheets

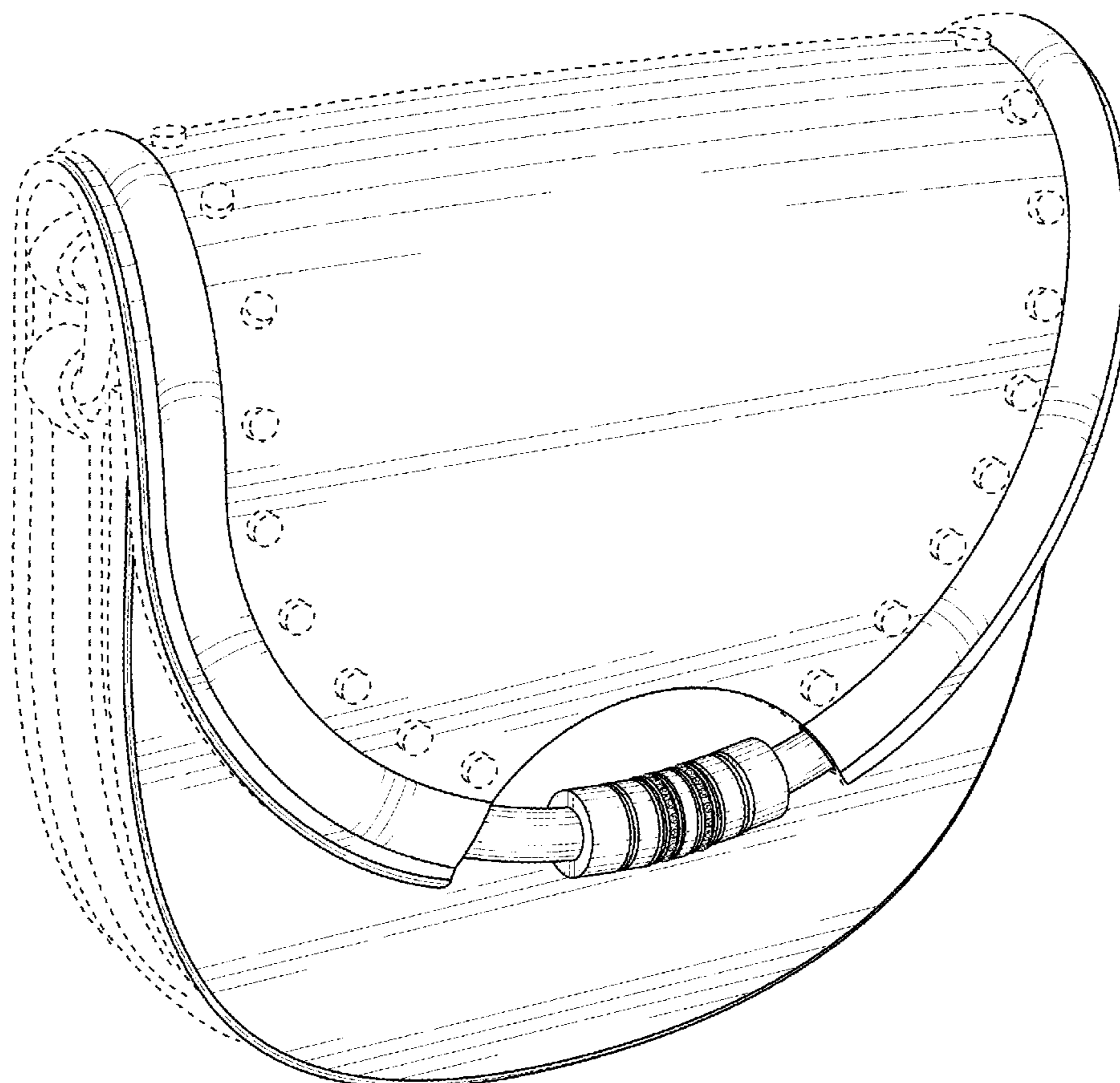

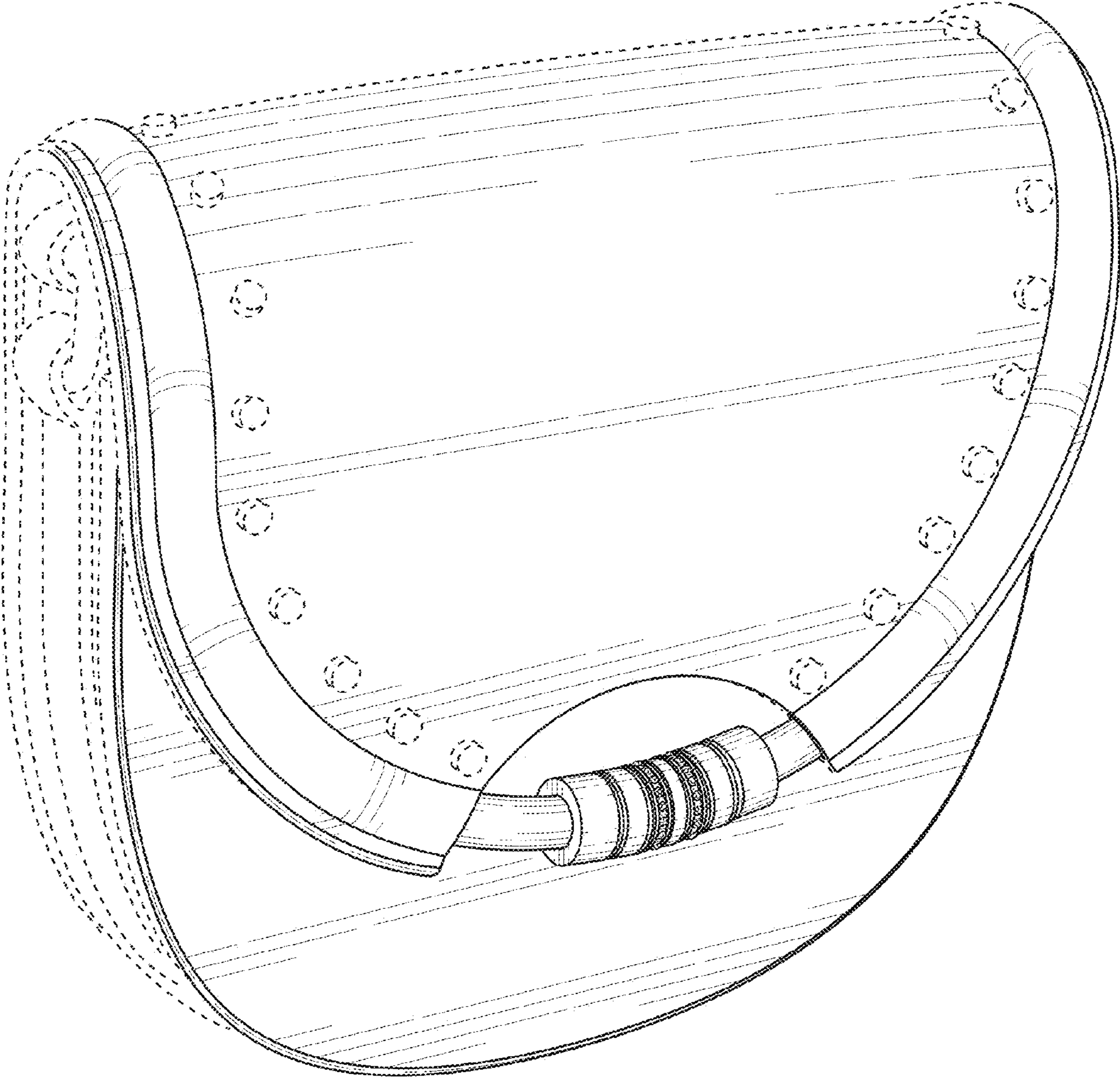

FIG. 1

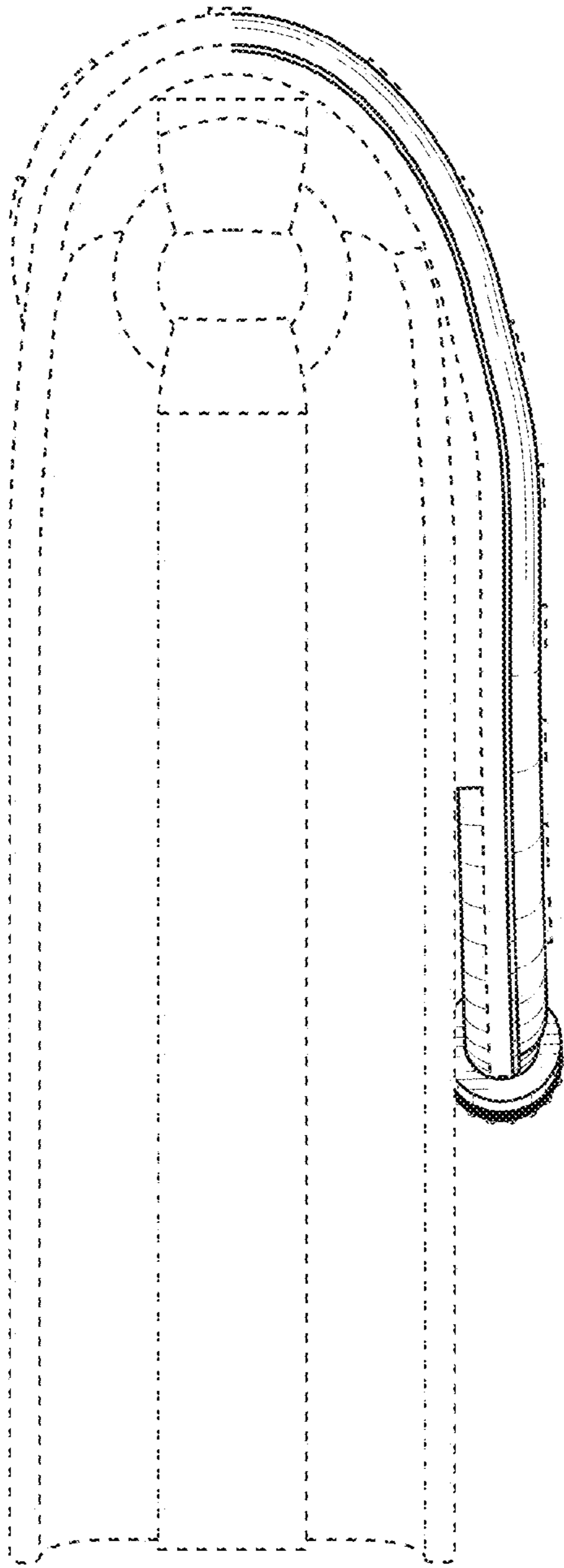

FIG. 2

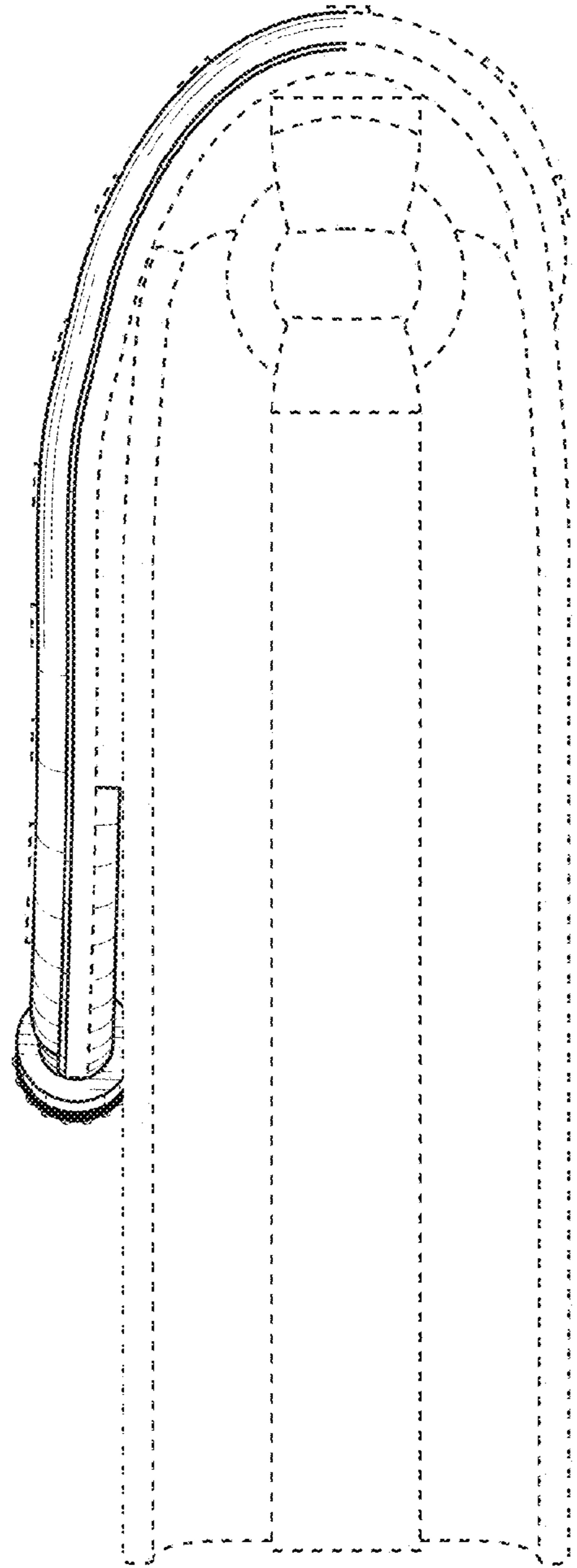

FIG. 3

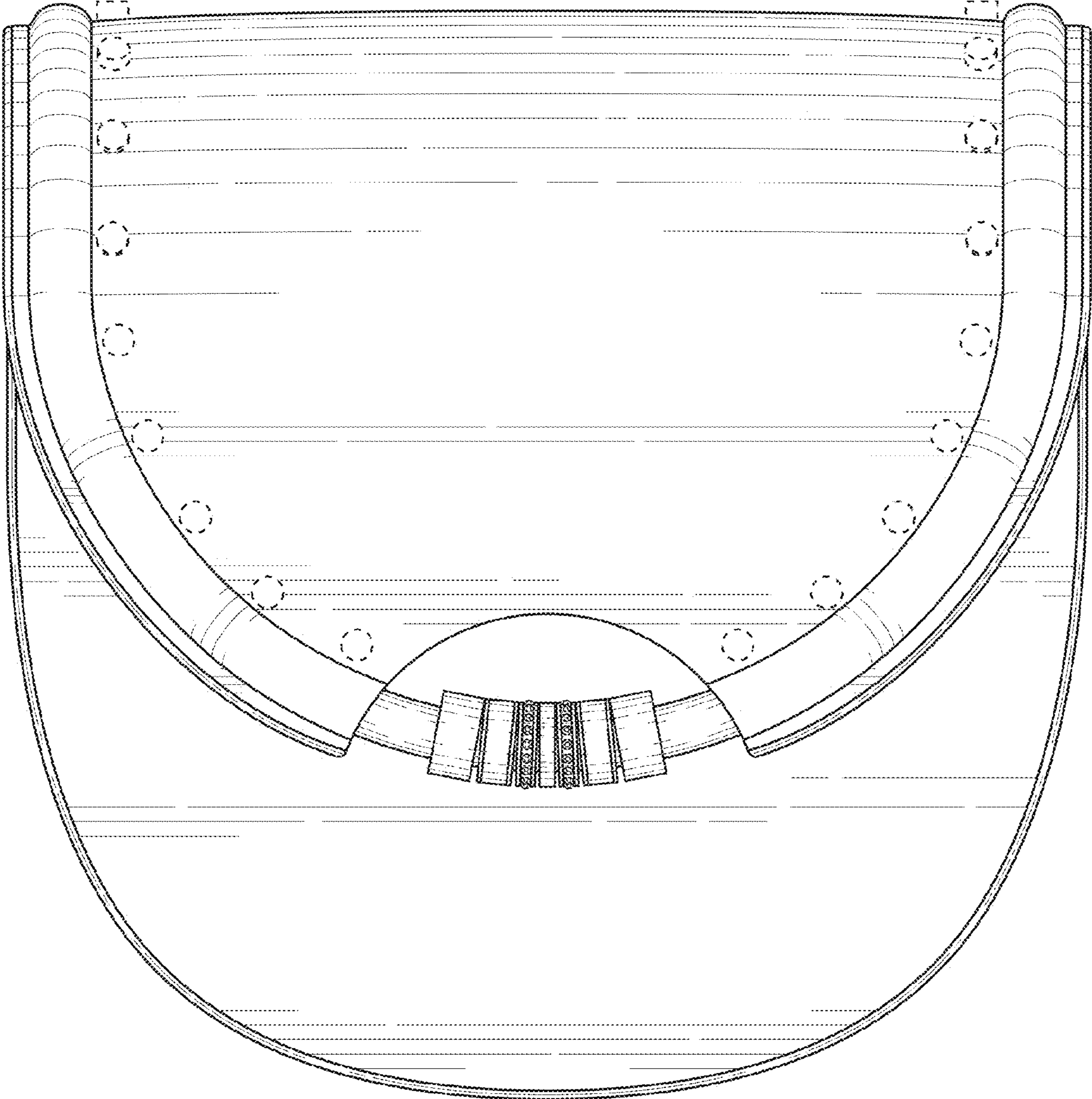

FIG. 4

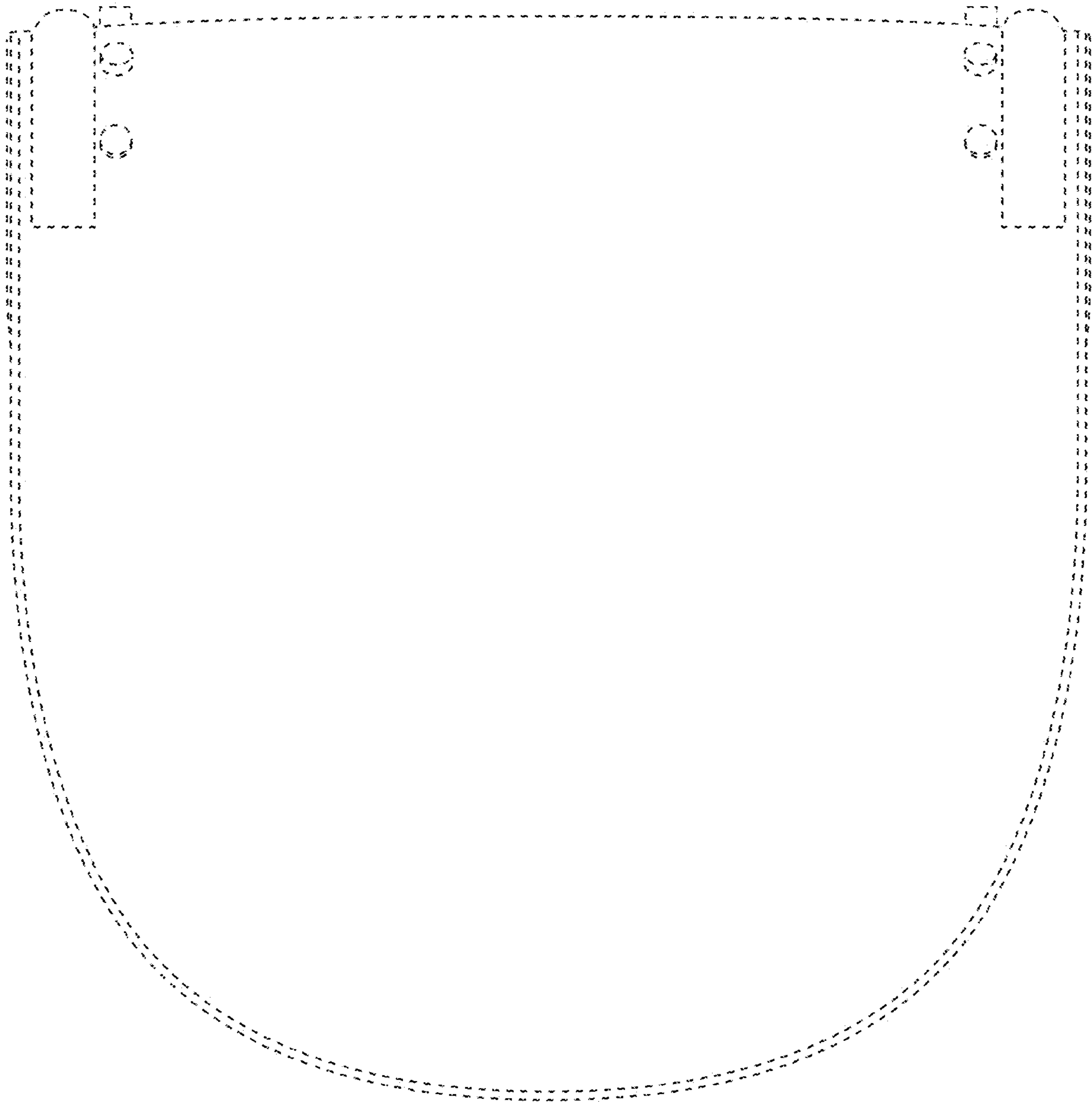

FIG. 5

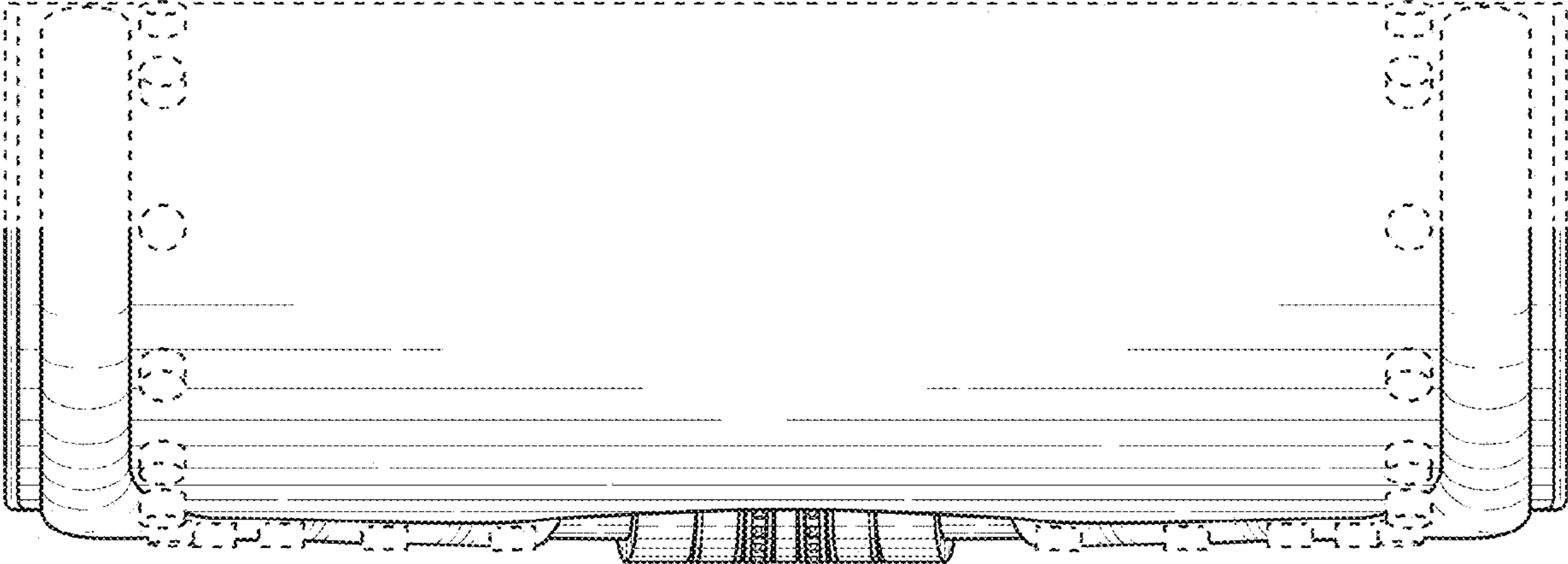

FIG. 6

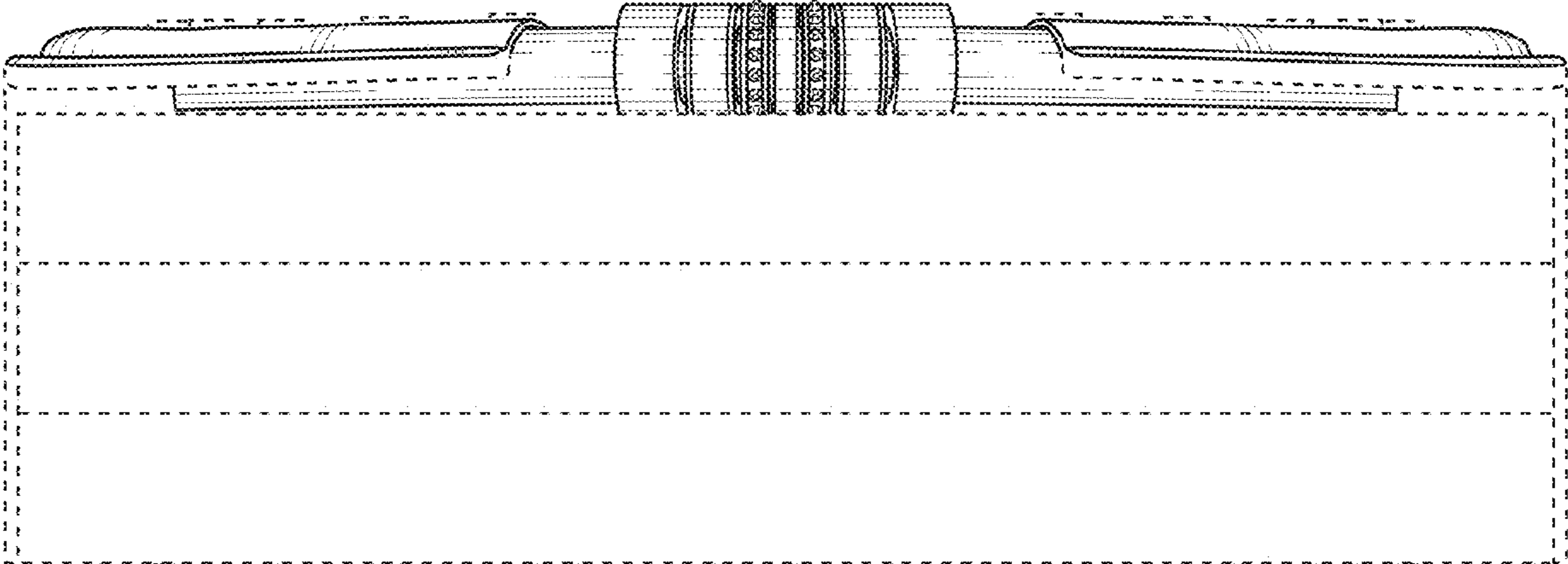

FIG. 7