



US00D876051S

(12) **United States Design Patent** (10) **Patent No.:** **US D876,051 S**
Abadjian (45) **Date of Patent:** **** Feb. 25, 2020**

(54) **FOOTWEAR**
(71) Applicant: **CROCS, INC.**, Niwot, CO (US)
(72) Inventor: **Joseph Abadjian**, Longmont, CO (US)
(73) Assignee: **Crocs, Inc.**, Niwot, CO (US)
(**) Term: **15 Years**
(21) Appl. No.: **29/697,876**
(22) Filed: **Jul. 11, 2019**

D642,773 S * 8/2011 Liow D2/896
D650,157 S 12/2011 Liow
D667,612 S * 9/2012 Del Biondi D2/896
D676,223 S 2/2013 Dill
D690,488 S 10/2013 Reed et al.
9,282,787 B2 3/2016 Ferniani et al.
D753,377 S 4/2016 Bigolin
D760,484 S 7/2016 Del Biondi et al.
D830,675 S * 10/2018 Del Biondi D2/923
D833,124 S 11/2018 Laska
D833,125 S 11/2018 Laska et al.
D833,126 S 11/2018 Laska

Related U.S. Application Data

(63) Continuation of application No. 29/590,088, filed on Jan. 6, 2017, now Pat. No. Des. 856,642.
(51) **LOC (12) Cl.** **02-04**
(52) **U.S. Cl.**
USPC **D2/923**; D2/916
(58) **Field of Classification Search**
USPC ... D2/896-900, 916, 917, 923, 943, 946-96,
D2/969, 972, 976
CPC A43B 1/10; A43B 3/10; A43B 3/12; A43B
17/18; A43B 1/12
See application file for complete search history.

OTHER PUBLICATIONS

U.S. Appl. No. 29/590,124, filed Jan. 6, 2017.
U.S. Appl. No. 29/590,088, filed Jul. 11, 2019.

* cited by examiner

Primary Examiner — Rashida C. Walshon
(74) *Attorney, Agent, or Firm* — Wilmer Cutler Pickering
Hale and Dorr LLP

(57) **CLAIM**

The ornamental design for footwear, as shown and described.

DESCRIPTION

FIG. 1 is a front perspective view of footwear;
FIG. 2 is a front view;
FIG. 3 is a back view;
FIG. 4 is an outer side view;
FIG. 5 is an inner side view;
FIG. 6 is a top view; and,
FIG. 7 is a bottom view.
The elements shown in FIGS. 1-7 in broken lines represent portions that form no part of the claimed design.

(56) **References Cited**

U.S. PATENT DOCUMENTS

D381,794 S * 8/1997 Gelli D2/916
D517,789 S 3/2006 Seamans
D529,263 S 10/2006 Wolf
D532,590 S 11/2006 Belley et al.
7,140,129 B2 11/2006 Newson et al.
D545,032 S * 6/2007 Wolf D2/923
D545,033 S * 6/2007 Wolf D2/926
D567,483 S * 4/2008 Liow D2/896
D613,485 S 4/2010 Meador

1 Claim, 7 Drawing Sheets

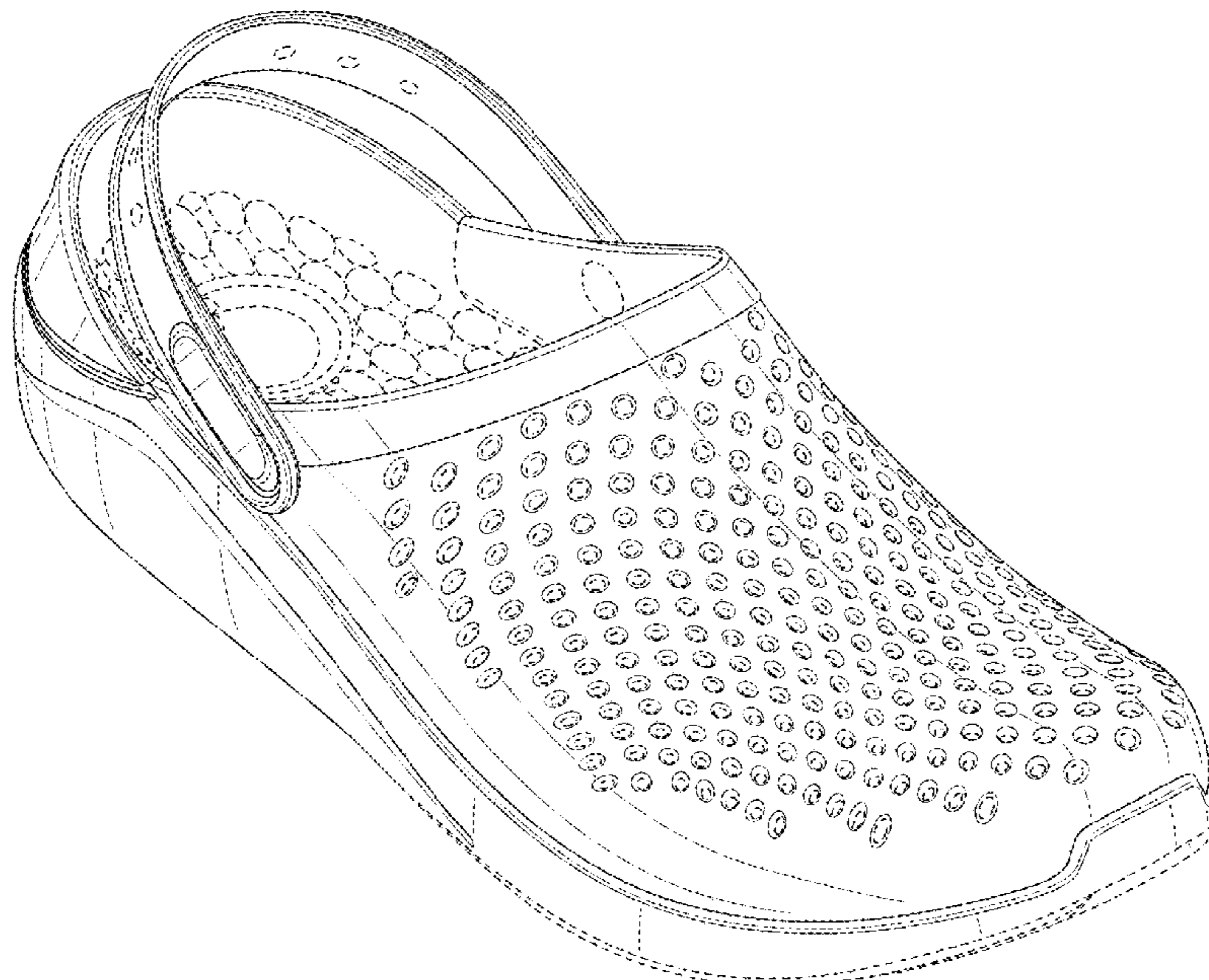

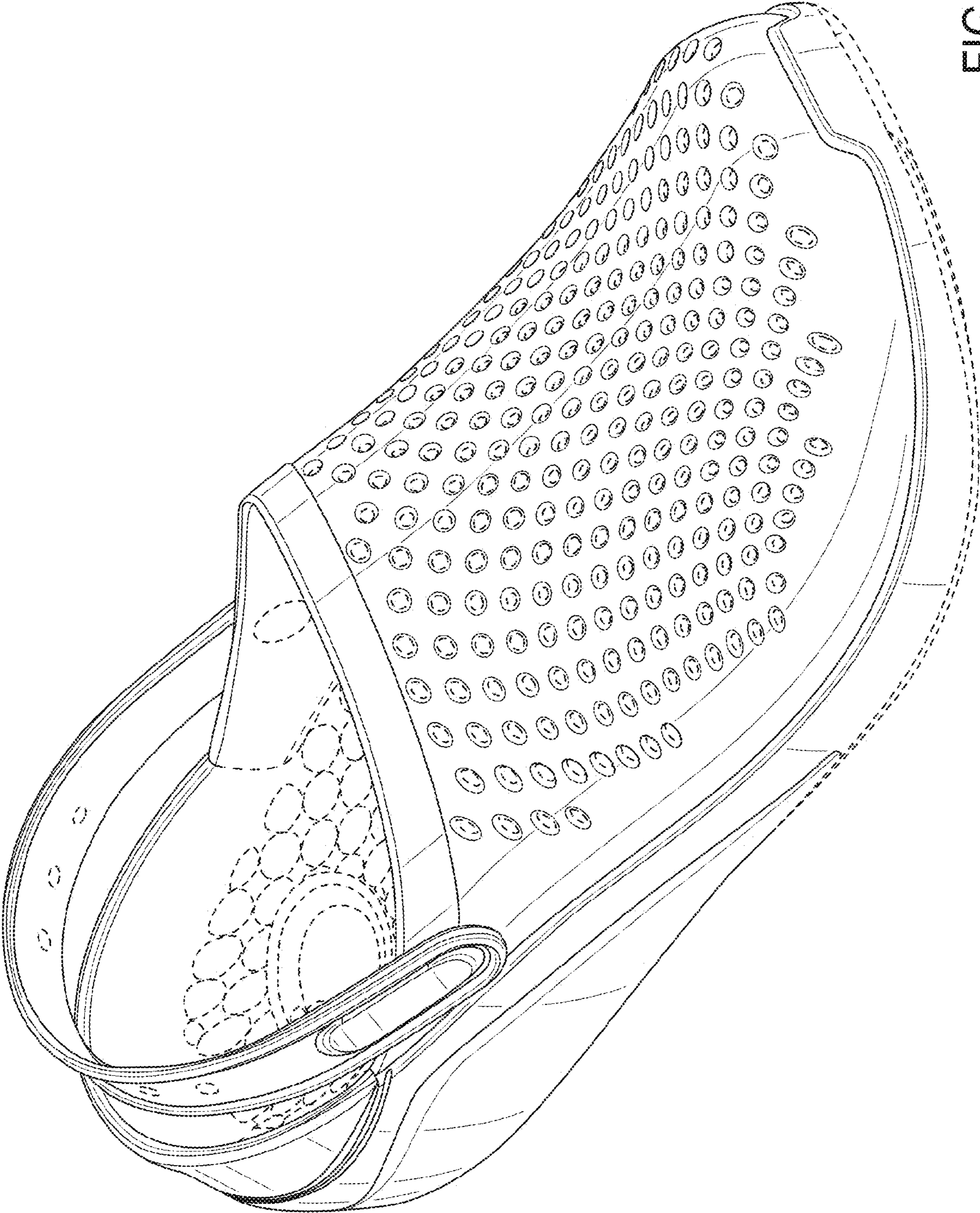

FIG. 1

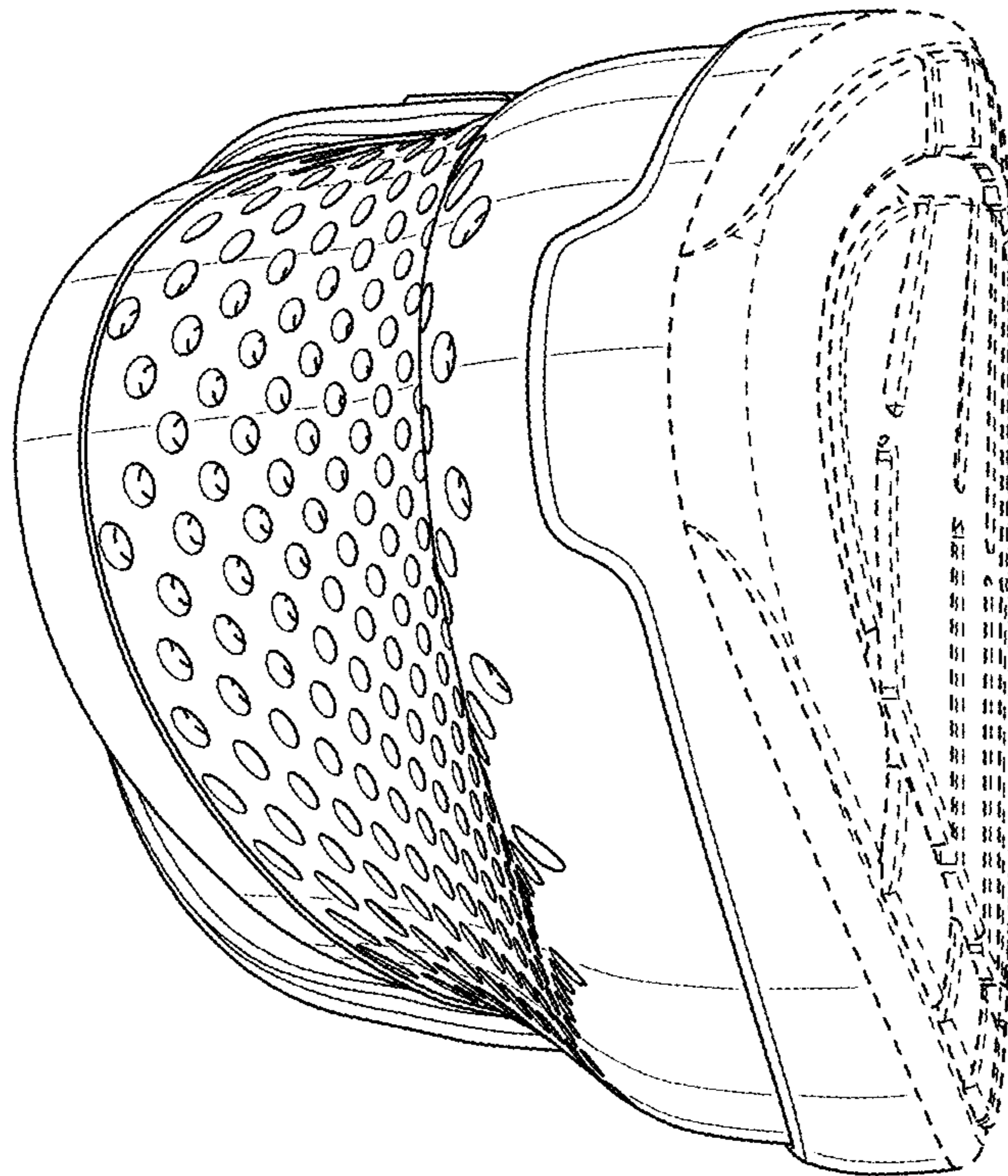

FIG. 2

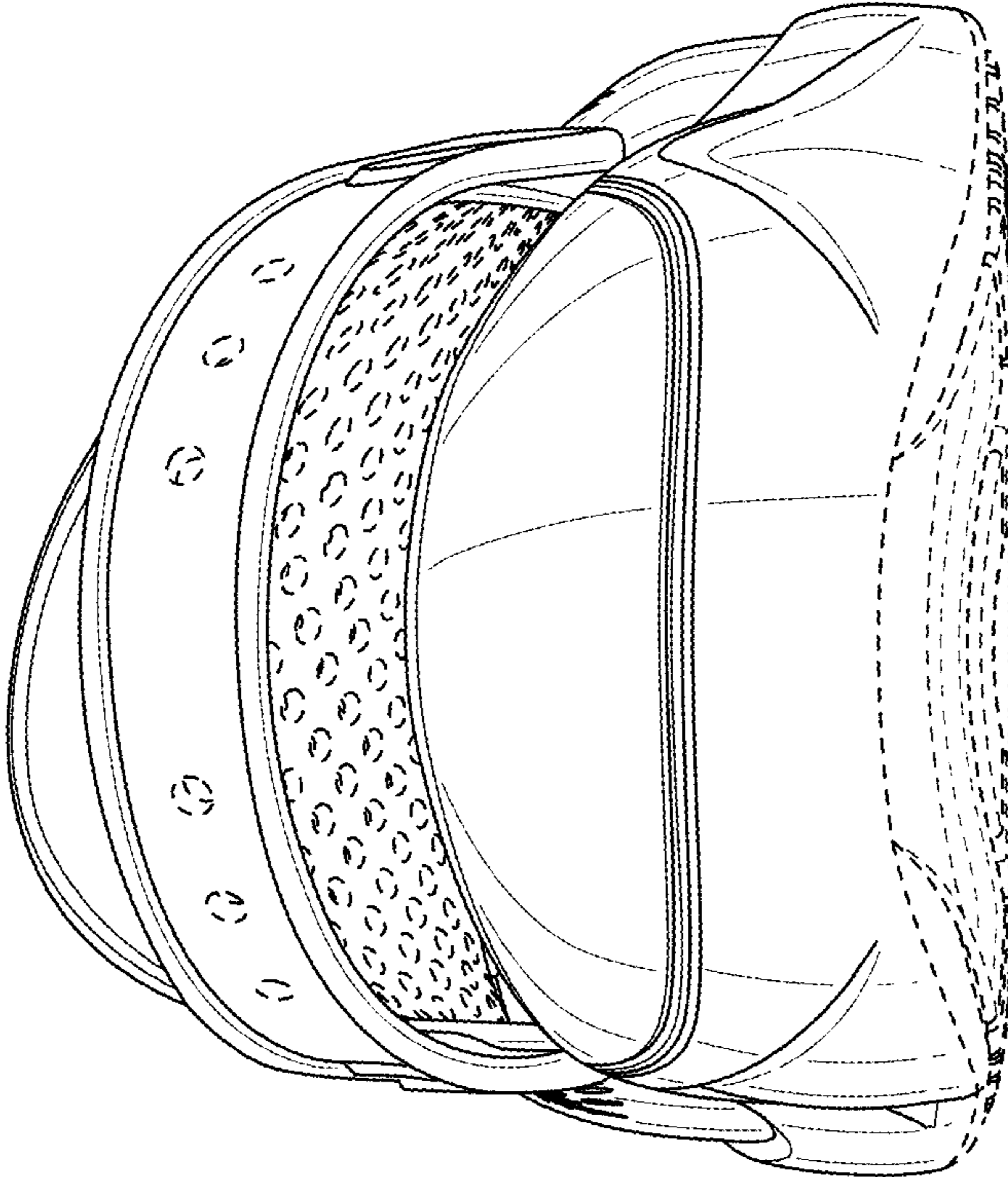

FIG. 3

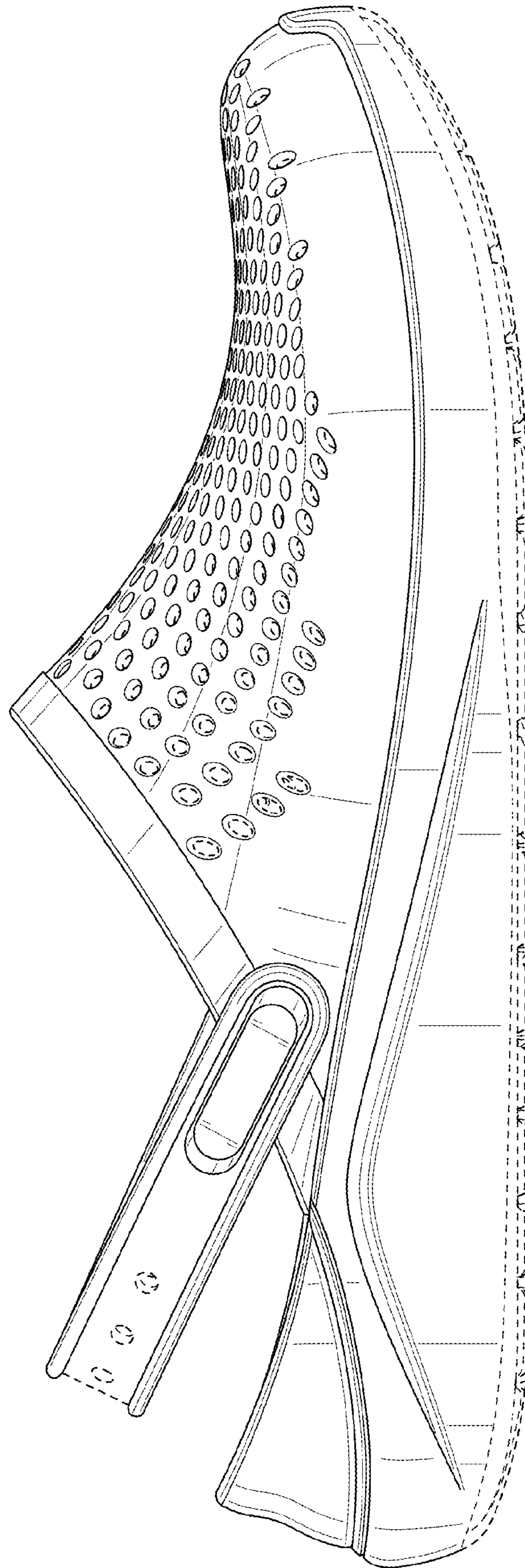

FIG. 4

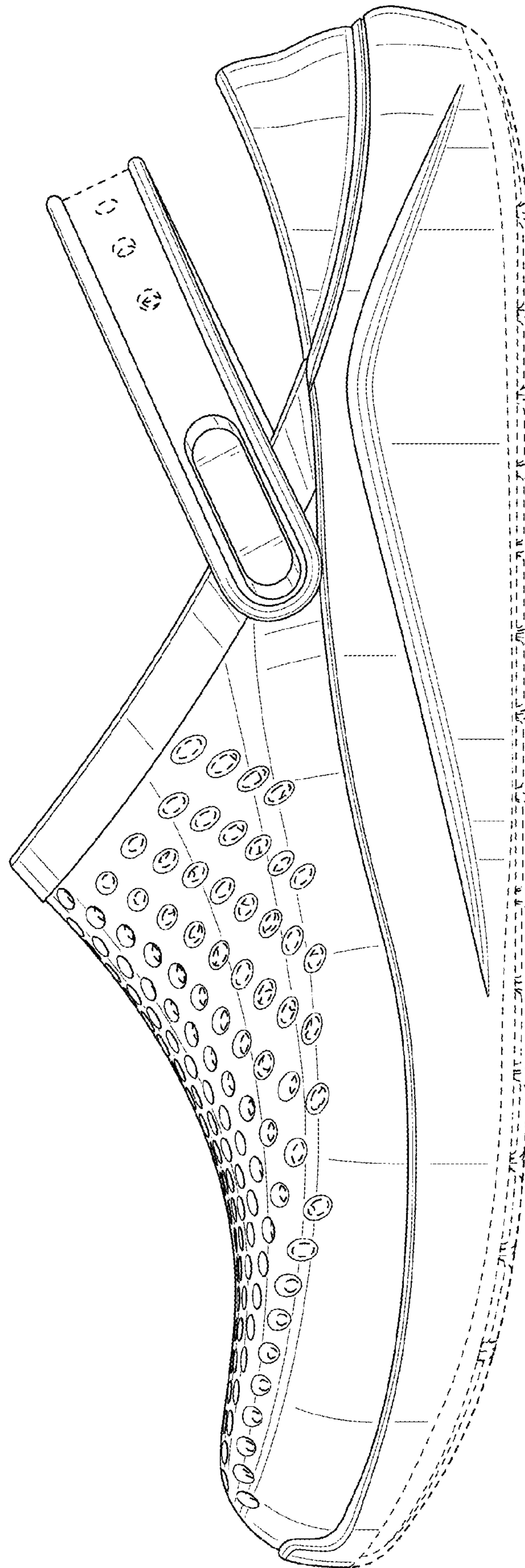

FIG. 5

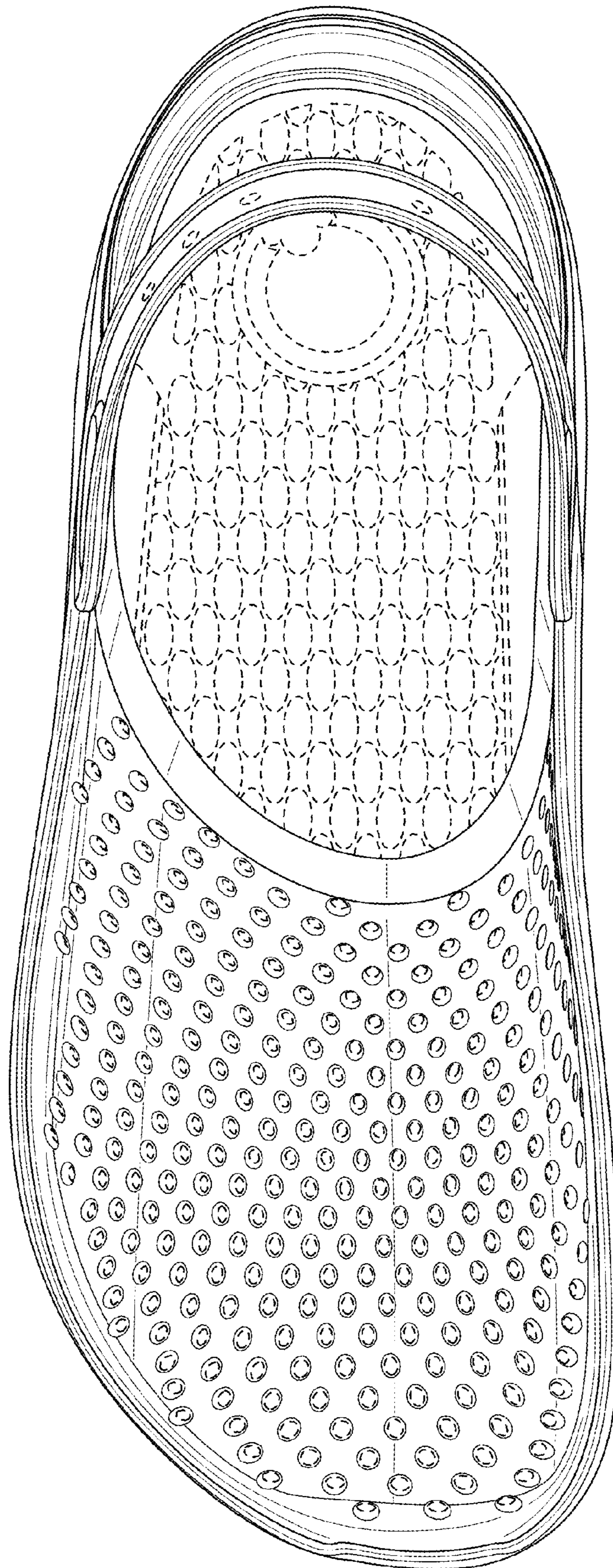

FIG. 6

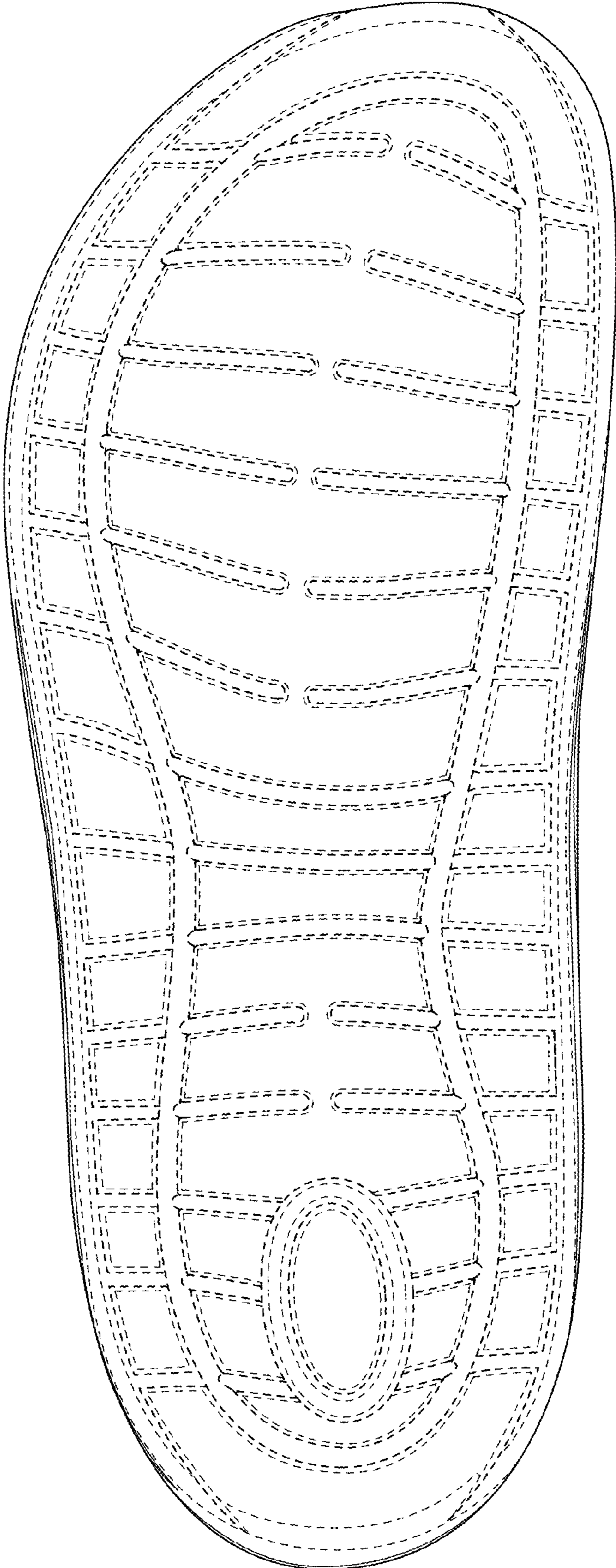

FIG. 7