



US00D876036S

(12) **United States Design Patent**
Irfan

(10) **Patent No.:** **US D876,036 S**

(45) **Date of Patent:** **** Feb. 18, 2020**

(54) **FLOOR CLEANER**

(71) Applicant: **TTI (MACAO COMMERCIAL OFFSHORE) LIMITED**, Macau (MO)

(72) Inventor: **Mohammed Irfan**, Huntersville, NC (US)

(73) Assignee: **TTI (Macao Commercial Offshore) Limited**, Praia Grande (MO)

(**) Term: **15 Years**

(21) Appl. No.: **29/626,383**

(22) Filed: **Nov. 16, 2017**

(30) **Foreign Application Priority Data**

May 17, 2017 (CN) 2017 3 0183433

(51) **LOC (12) Cl.** **15-05**

(52) **U.S. Cl.**
USPC **D32/22**

(58) **Field of Classification Search**
USPC D32/22, 31, 17
CPC A47L 11/20; A47L 11/34; A47L 11/40;
A47L 11/4016; A47L 5/28; A47L 5/24;
A47L 7/02

See application file for complete search history.

(56) **References Cited**

U.S. PATENT DOCUMENTS

D646,856 S * 10/2011 Breit D32/22
D768,944 S * 10/2016 Zhang D32/22

D804,751 S * 12/2017 Johnson D32/22
10,092,155 B2 * 10/2018 Xia A47L 11/302
D836,863 S * 12/2018 Theising D32/22
D837,469 S * 1/2019 Johnson D32/22
D844,914 S * 4/2019 Houghton D32/22

* cited by examiner

Primary Examiner — Ruth McInroy

(74) *Attorney, Agent, or Firm* — Michael Best & Friedrich LLP

(57) **CLAIM**

I claim the ornamental design for a floor cleaner, as shown and described.

DESCRIPTION

FIG. 1 is a front perspective view of a floor cleaner showing our new design;
FIG. 2 is a front view thereof;
FIG. 3 is a rear view thereof;
FIG. 4 is a left side view thereof;
FIG. 5 is a right side view thereof;
FIG. 6 is a top view thereof; and,
FIG. 7 is a bottom view thereof.
Elements shown in broken lines are included for the purpose of showing environment and form no part of the claimed design.

1 Claim, 6 Drawing Sheets

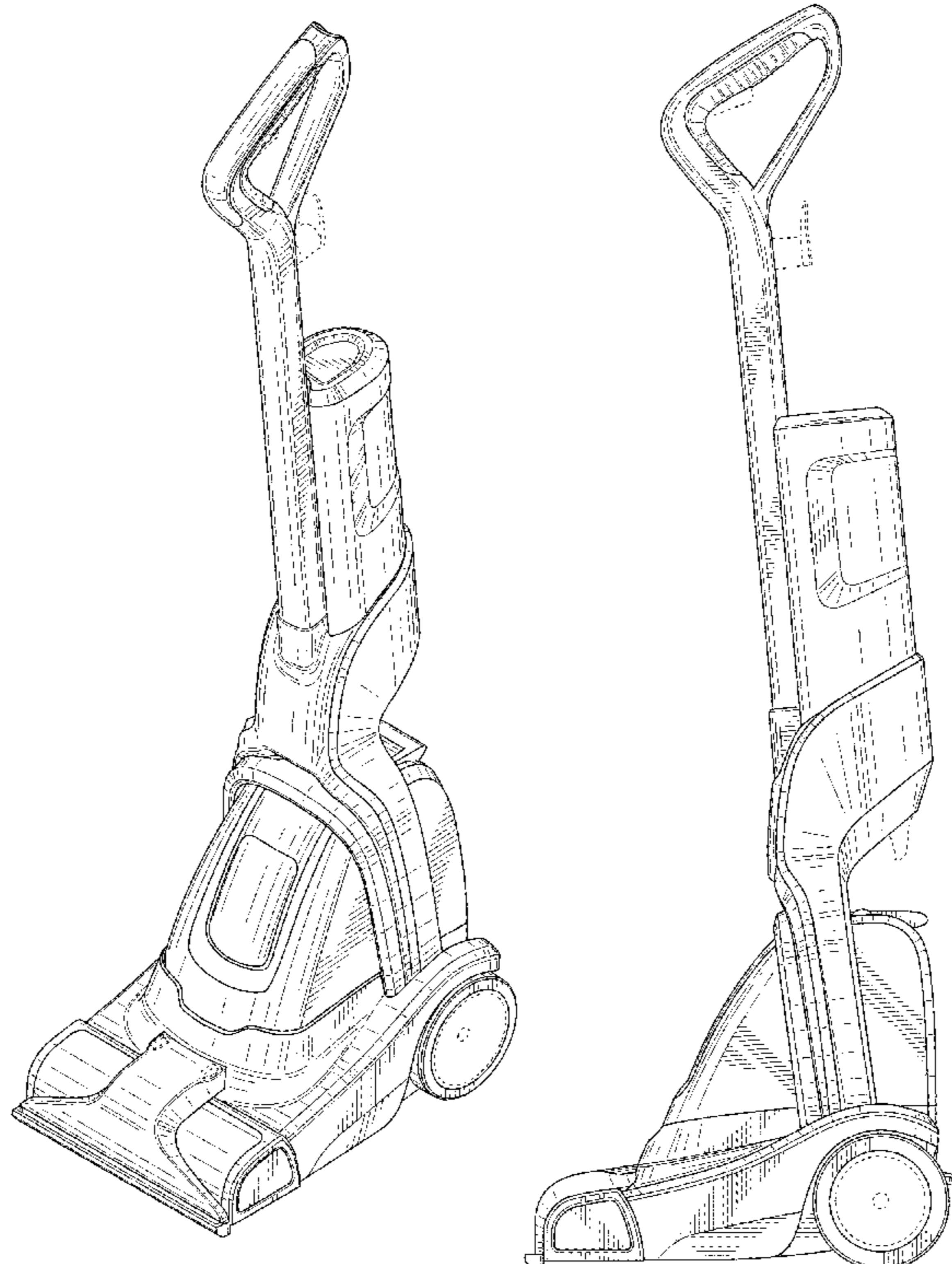

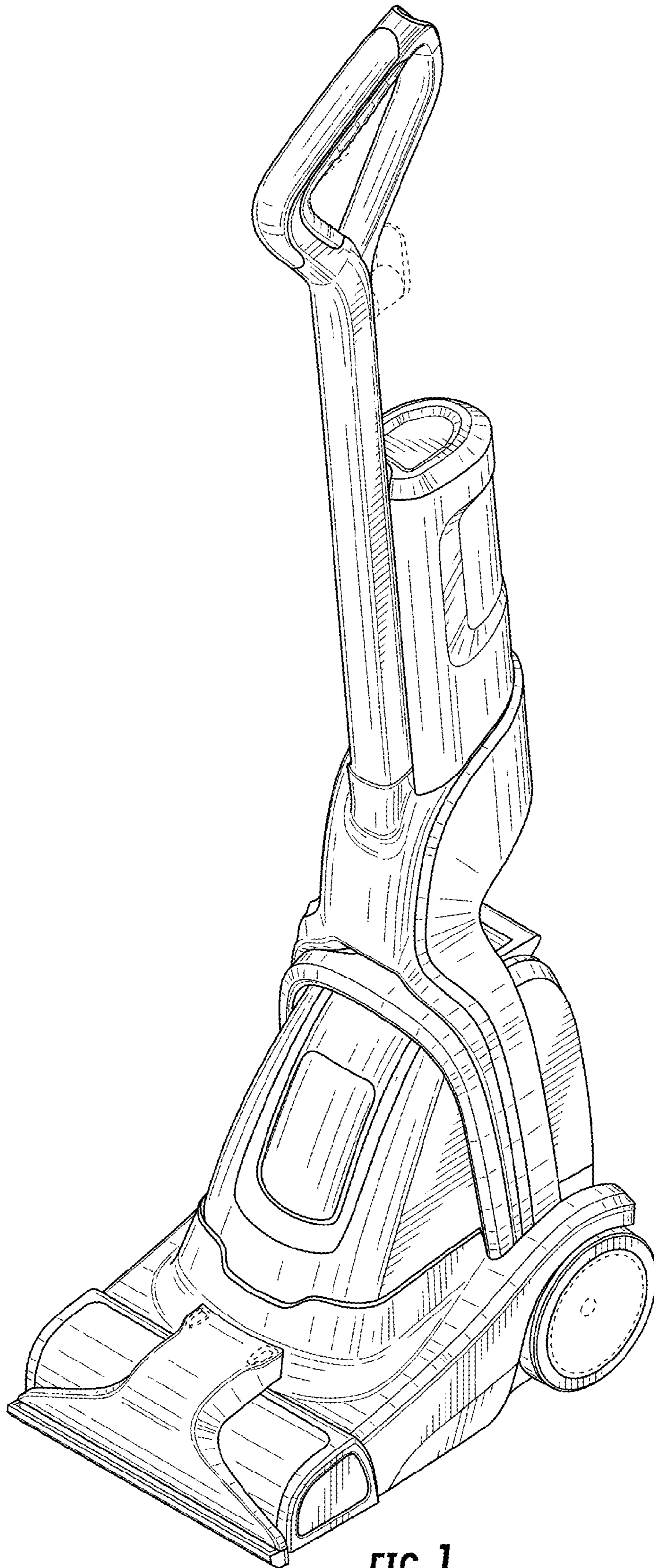

FIG. 1

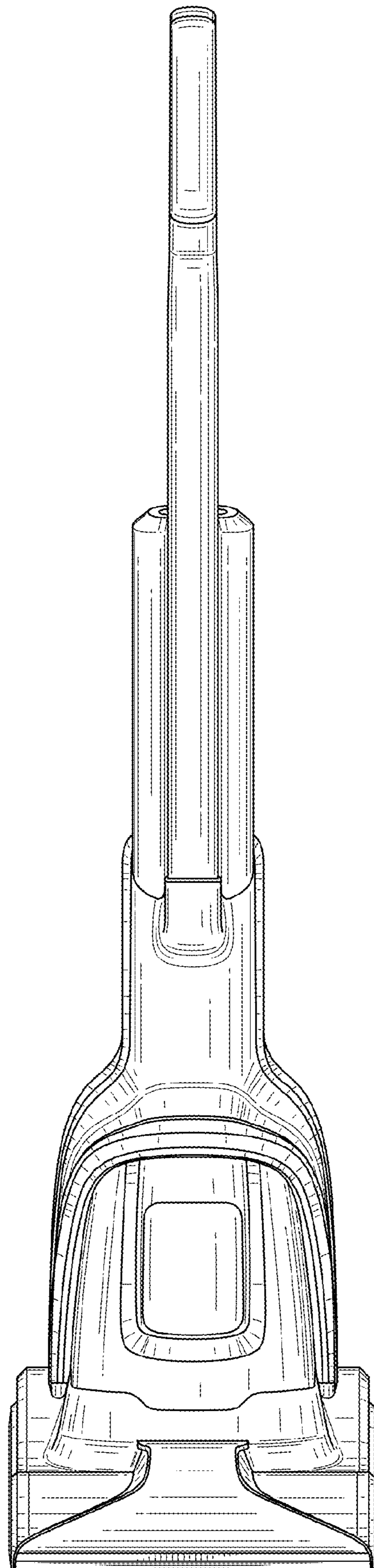

FIG. 2

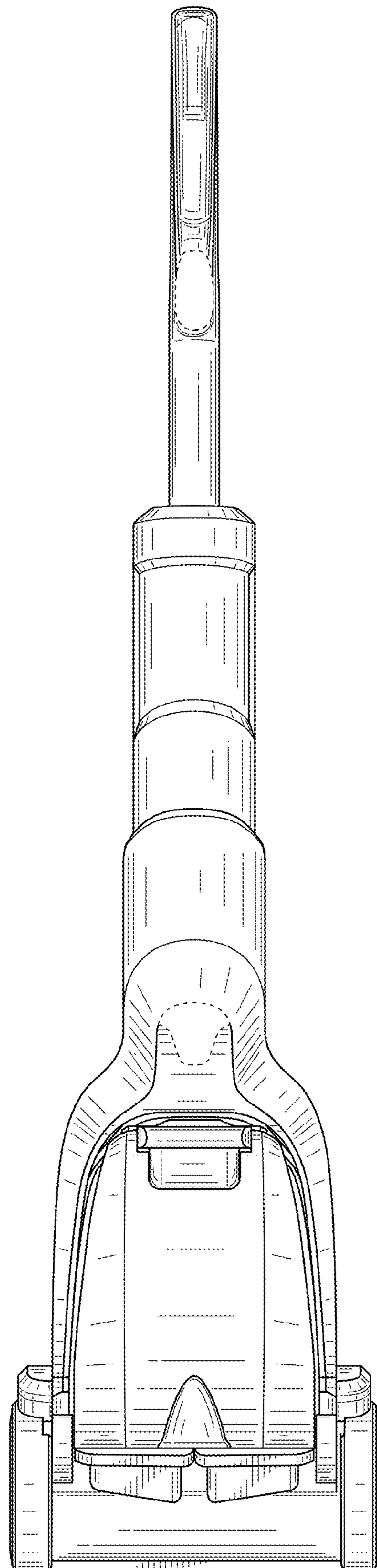

FIG. 3

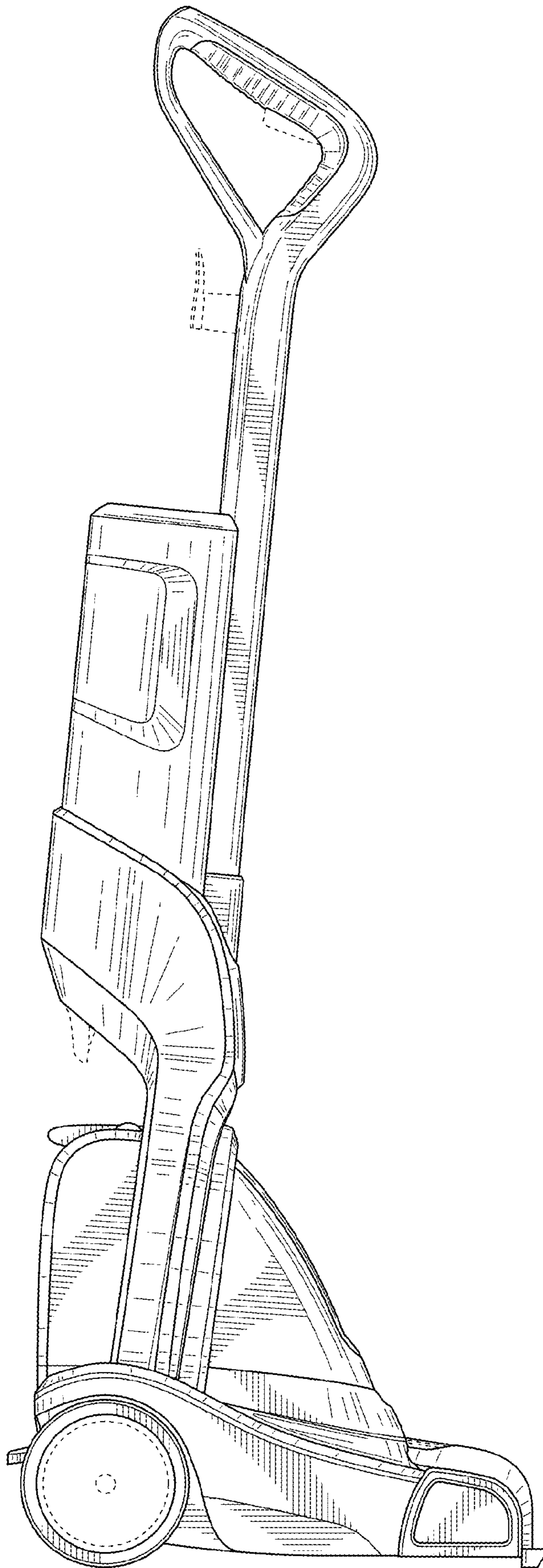

FIG. 4

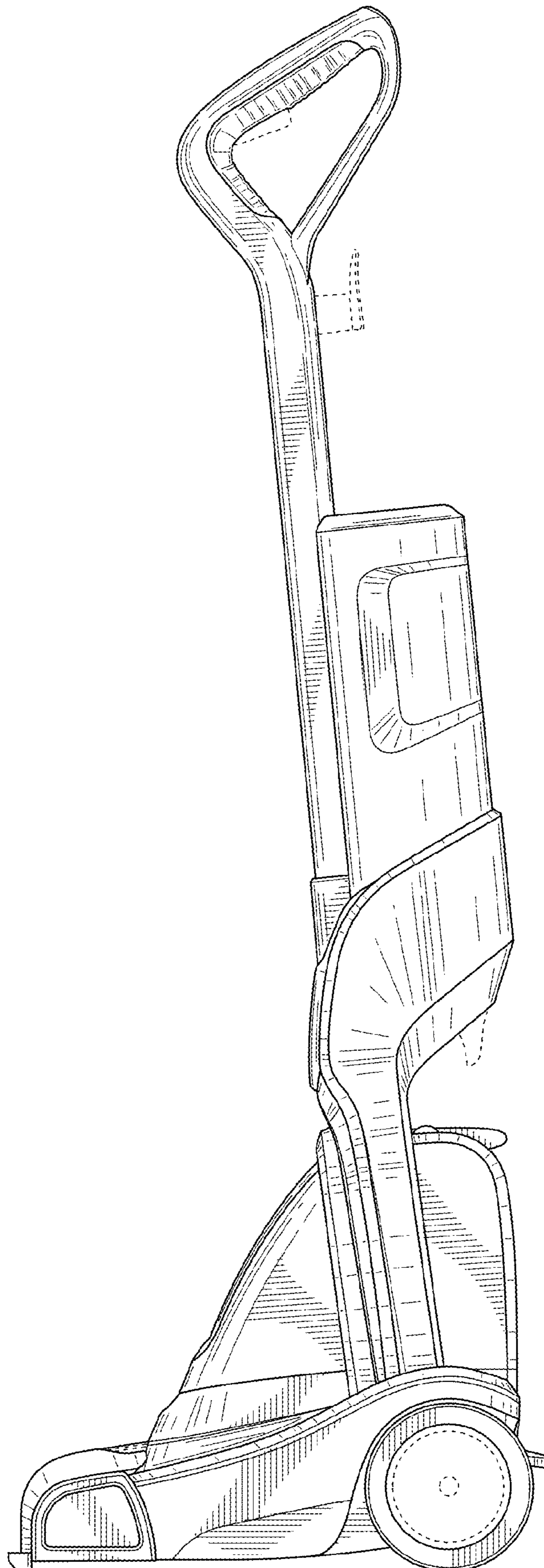

FIG. 5

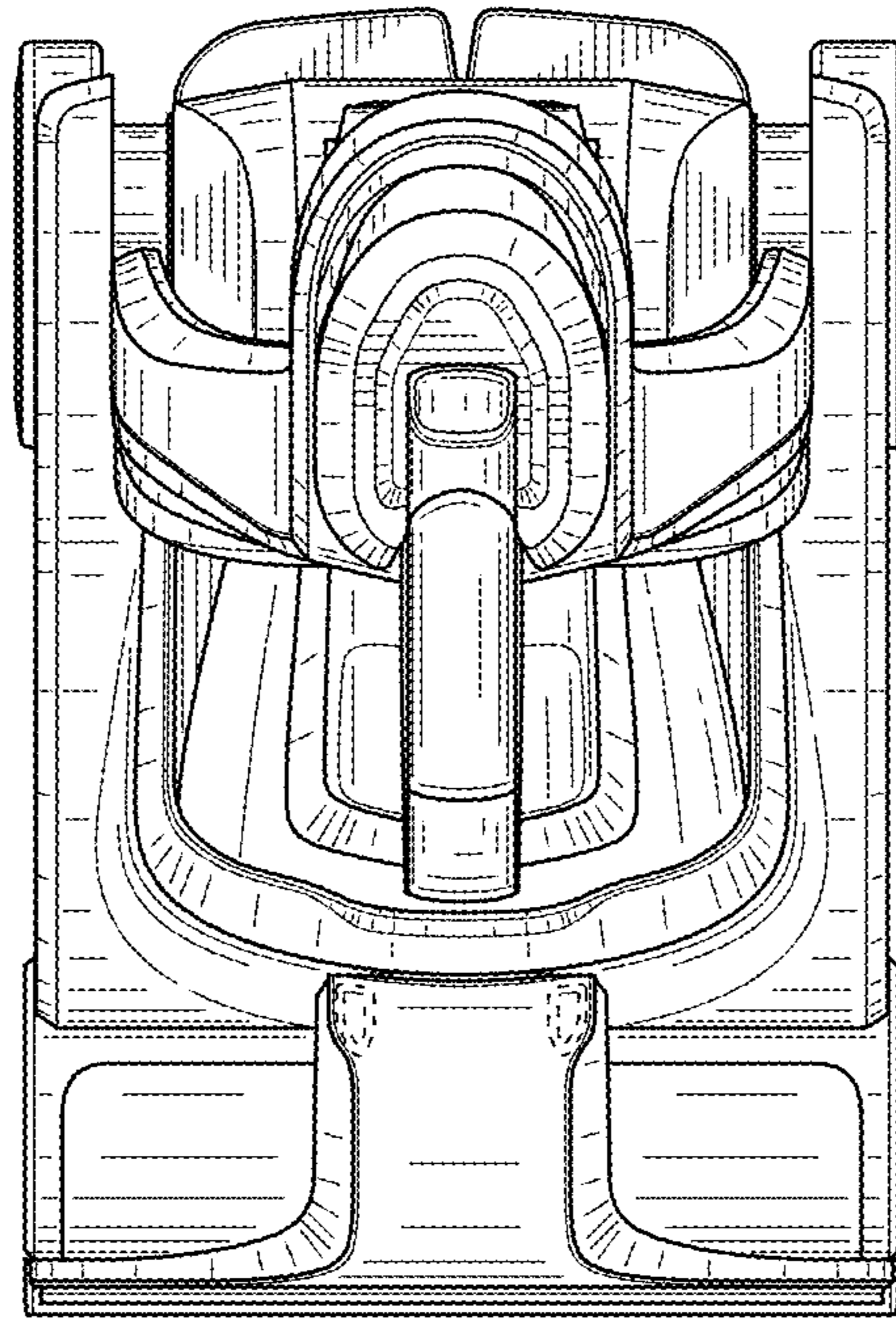

FIG. 6

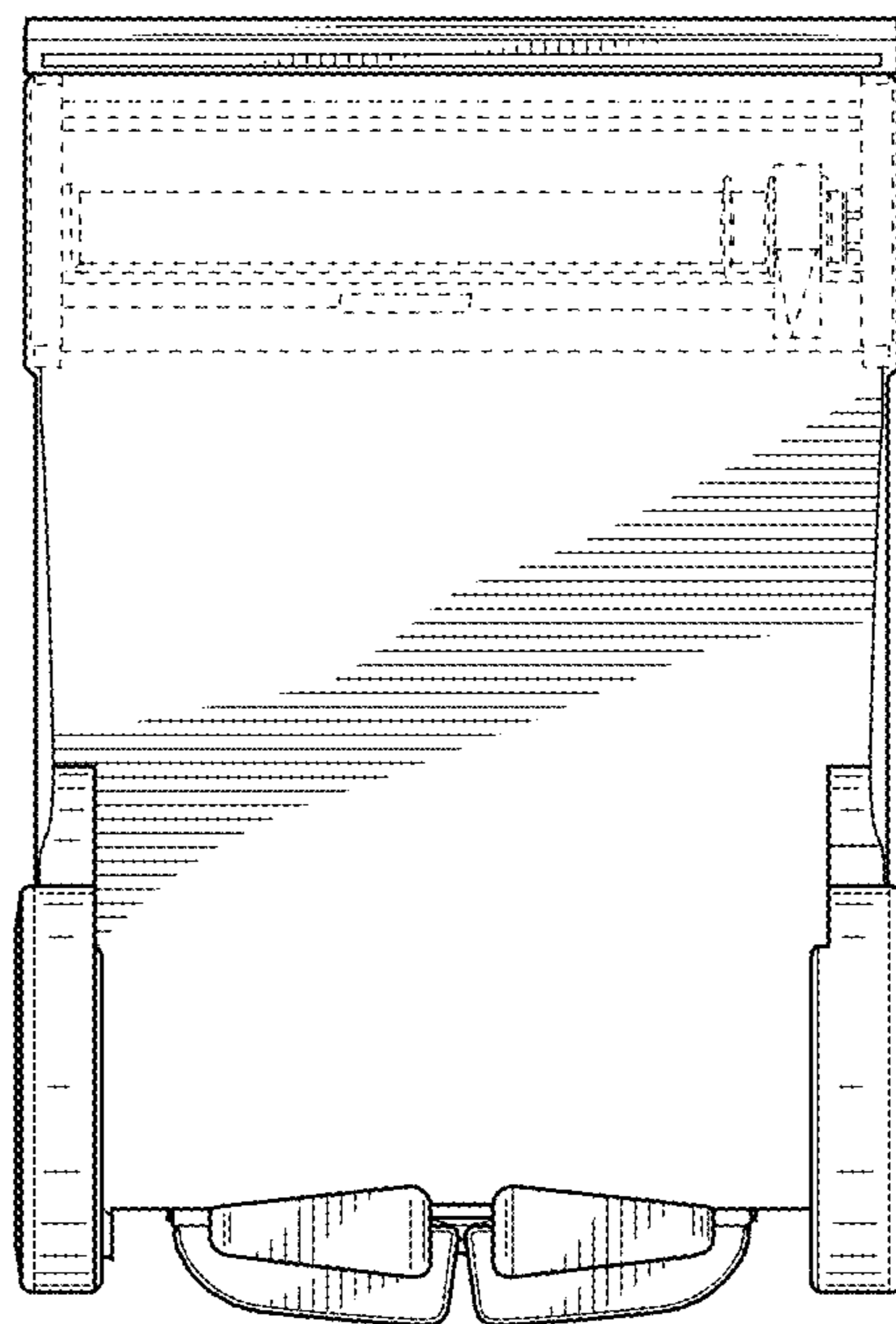

FIG. 7