



US00D876018S

(12) **United States Design Patent** (10) **Patent No.:** **US D876,018 S**  
**Dulude et al.** (45) **Date of Patent:** **\*\* Feb. 18, 2020**

(54) **METATARSAL GUARD**

(71) Applicant: **TBL Licensing LLC**, Stratham, NH (US)

(72) Inventors: **Ryan Dulude**, Lee, NH (US); **Stephen Douglas Ammon**, Hampton, NH (US); **Emily V. Miller**, Eliot, ME (US)

(73) Assignee: **TBL Licensing LLC**, Stratham, NH (US)

(\*\*) Term: **15 Years**

(21) Appl. No.: **29/667,246**

(22) Filed: **Oct. 19, 2018**

(51) **LOC (12) Cl.** ..... **29-02**

(52) **U.S. Cl.**  
USPC ..... **D29/121.2; D2/909**

(58) **Field of Classification Search**  
USPC ..... D29/101.1, 101.3, 101.4, 101.5, 100,  
D29/120.1, 121.1, 121.2; 428/51, 131,  
(Continued)

(56) **References Cited**

U.S. PATENT DOCUMENTS

4,972,609 A \* 11/1990 Oh ..... A43B 5/00  
36/114  
6,631,569 B1 \* 10/2003 Scharbius ..... A43B 7/32  
36/136

(Continued)

OTHER PUBLICATIONS

Reebok internal view, Jun. 15, 2018, 4 pages.

(Continued)

*Primary Examiner* — Randall H Gholson

(74) *Attorney, Agent, or Firm* — Lerner, David,  
Littenberg, Krumholz & Mentlik, LLP

(57) **CLAIM**

The ornamental design for a metatarsal guard, as shown and described.

**DESCRIPTION**

The present application is filed along with U.S. Design patent application Ser. Nos. 29/667,244 and 29/667,268, the disclosures of which are incorporated herein by reference. FIG. 1 is a perspective view of a metatarsal guard according to a first embodiment of the design; FIG. 2 is a top view of a metatarsal guard of the embodiment of FIG. 1; FIG. 3 is a bottom view of a metatarsal guard of the embodiment of FIG. 1; FIG. 4 is a left view of a metatarsal guard of the embodiment of FIG. 1; FIG. 5 is a right view of a metatarsal guard of the embodiment of FIG. 1; FIG. 6 is a rear view of a metatarsal guard of the embodiment of FIG. 1; FIG. 7 is a front view of a metatarsal guard of the embodiment of FIG. 1; FIG. 8 is a perspective view of a metatarsal guard according to a second embodiment of the design; FIG. 9 is a top view of a metatarsal guard of the embodiment of FIG. 8; FIG. 10 is a bottom view of a metatarsal guard of the embodiment of FIG. 8; FIG. 11 is a left view of a metatarsal guard of the embodiment of FIG. 8; FIG. 12 is a right view of a metatarsal guard of the embodiment of FIG. 8; FIG. 13 is a rear view of a metatarsal guard of the embodiment of FIG. 8; FIG. 14 is a front view of a metatarsal guard of the embodiment of FIG. 8; FIG. 15 is a perspective view of a metatarsal guard according to a third embodiment of the design; FIG. 16 is a top view of a metatarsal guard of the embodiment of FIG. 15; FIG. 17 is a bottom view of a metatarsal guard of the embodiment of FIG. 15;

(Continued)

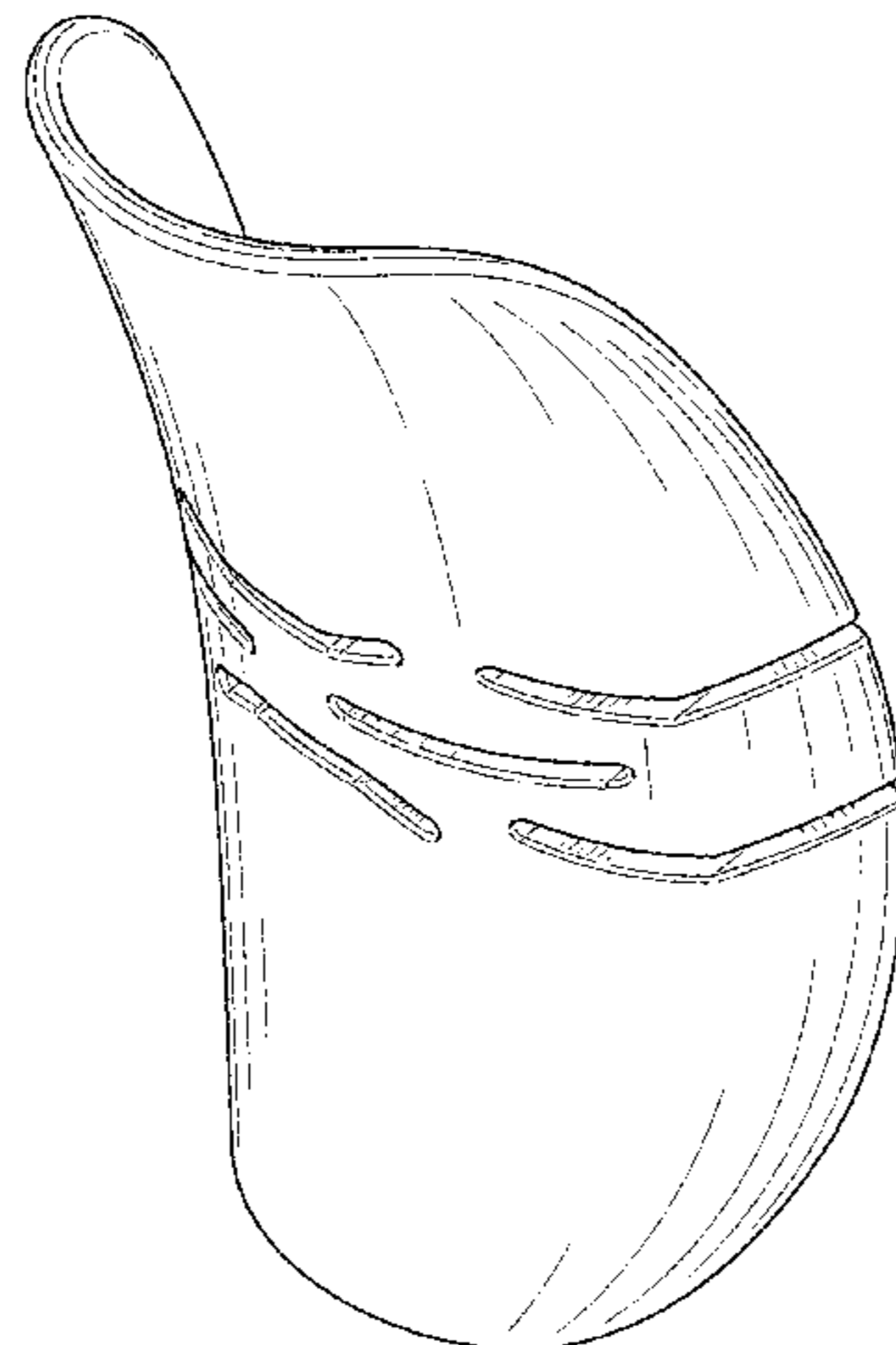

FIG. 18 is a left view of a metatarsal guard of the embodiment of FIG. 15;

FIG. 19 is a right view of a metatarsal guard of the embodiment of FIG. 15;

FIG. 20 is a rear view of a metatarsal guard of the embodiment of FIG. 15; and,

FIG. 21 is a front view of a metatarsal guard of the embodiment of FIG. 15.

The broken lines are included for illustrating environmental aspects only and form no part of the claimed design.

**1 Claim, 12 Drawing Sheets**

(58) **Field of Classification Search**

USPC ..... 428/196; D5/47, 54, 55, 56, 57; D6/582; D32/40; 442/327, 394; 451/523, 533, 451/537, 539; D8/90; D2/909, 946

CPC ..... A41D 13/015; A41D 13/0543; A63B 71/1225

See application file for complete search history.

(56)

**References Cited**

U.S. PATENT DOCUMENTS

D555,291 S \* 11/2007 Danzo ..... D29/121.2  
D696,499 S \* 12/2013 Lehtinen ..... D2/909  
D793,073 S \* 8/2017 Hardman ..... D2/973  
D805,274 S \* 12/2017 Maxie ..... D2/909

OTHER PUBLICATIONS

Product, Reebok Beamer men's sneaker [online] [retrieved Mar. 21, 2019] Retrieved from the internet: URL:<http://reebokwork.com/338/Reebok-Beamer-RB1067>, date not known, 4 pages.

\* cited by examiner

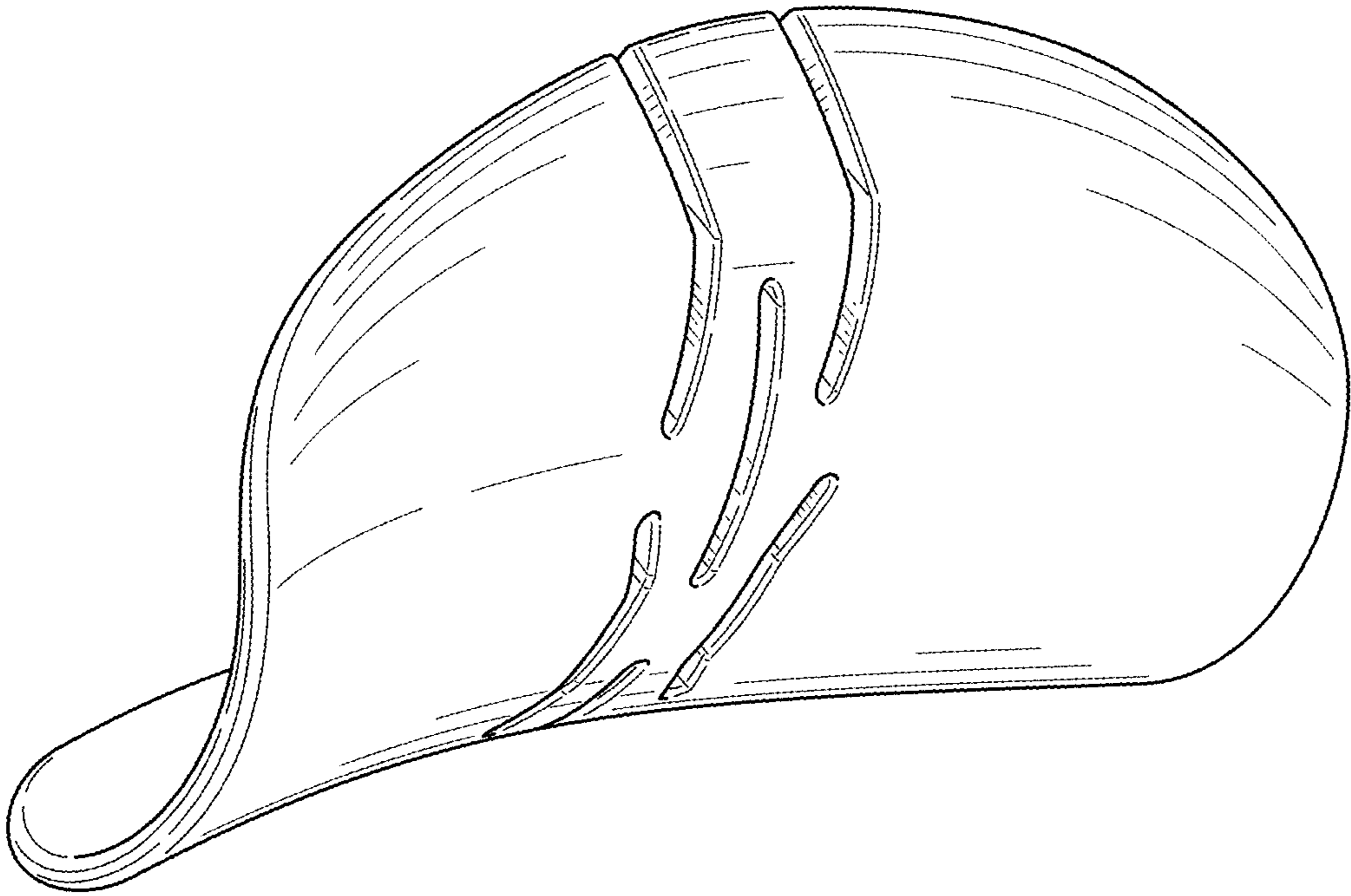

FIG. 1

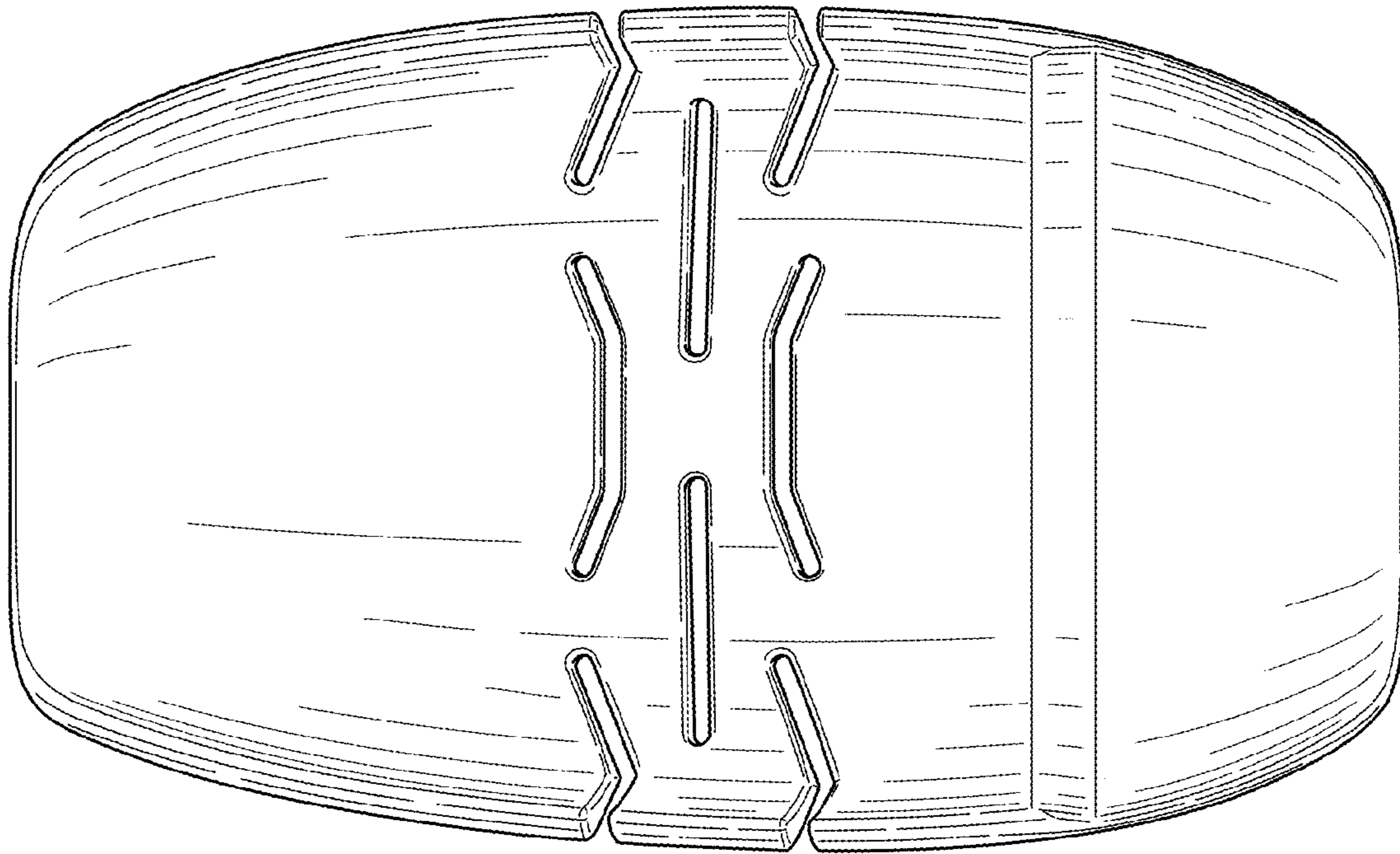

FIG. 3

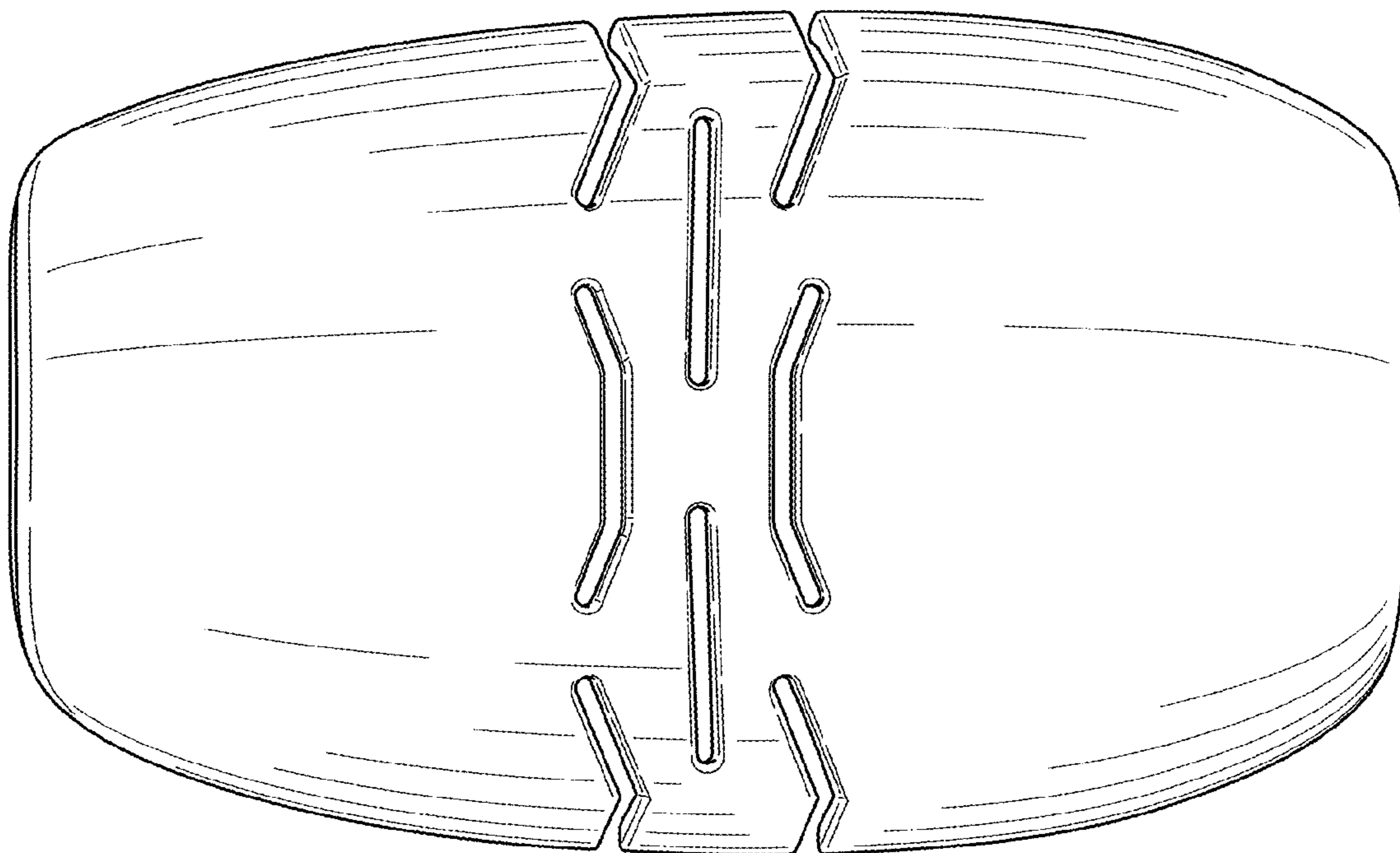

FIG. 2



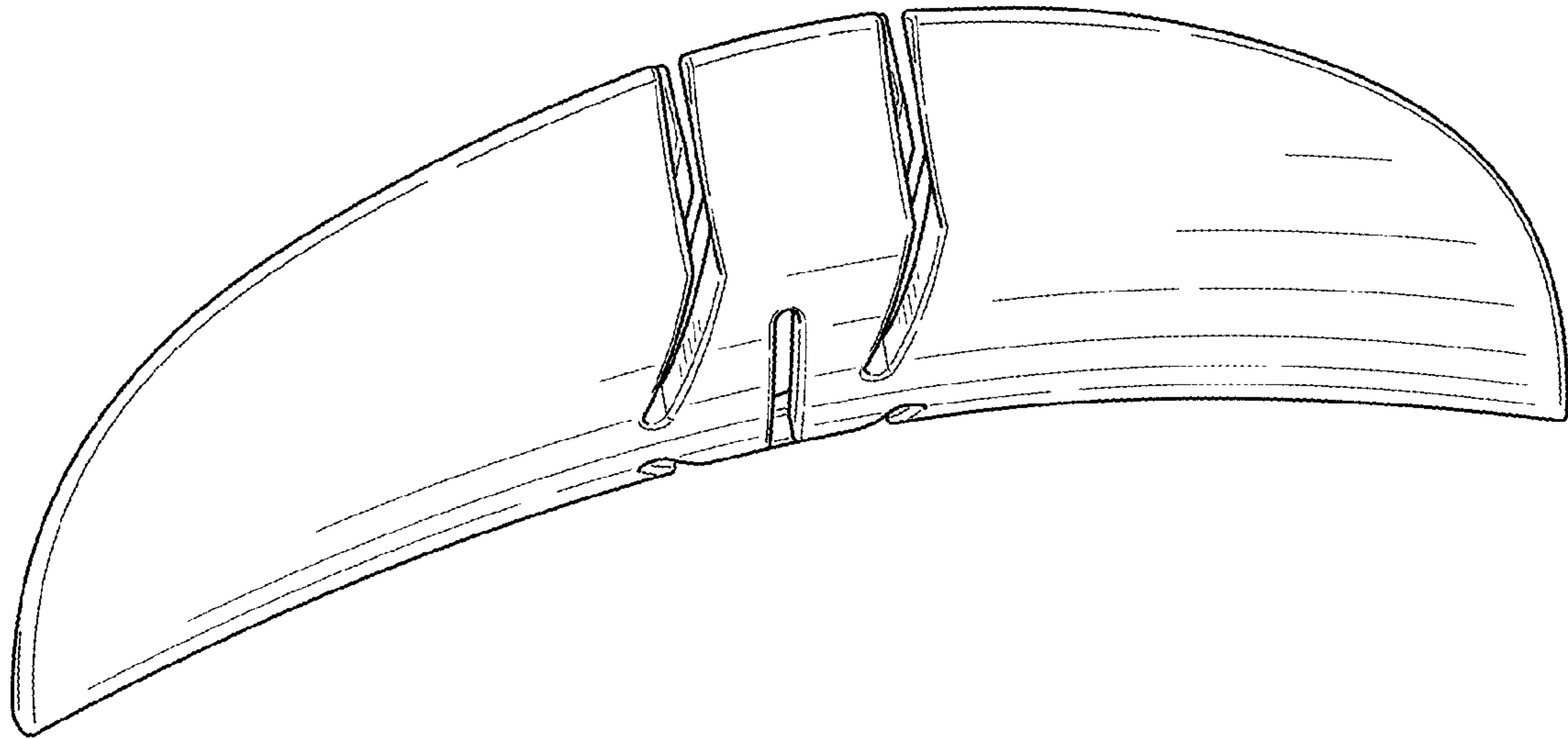

FIG. 5

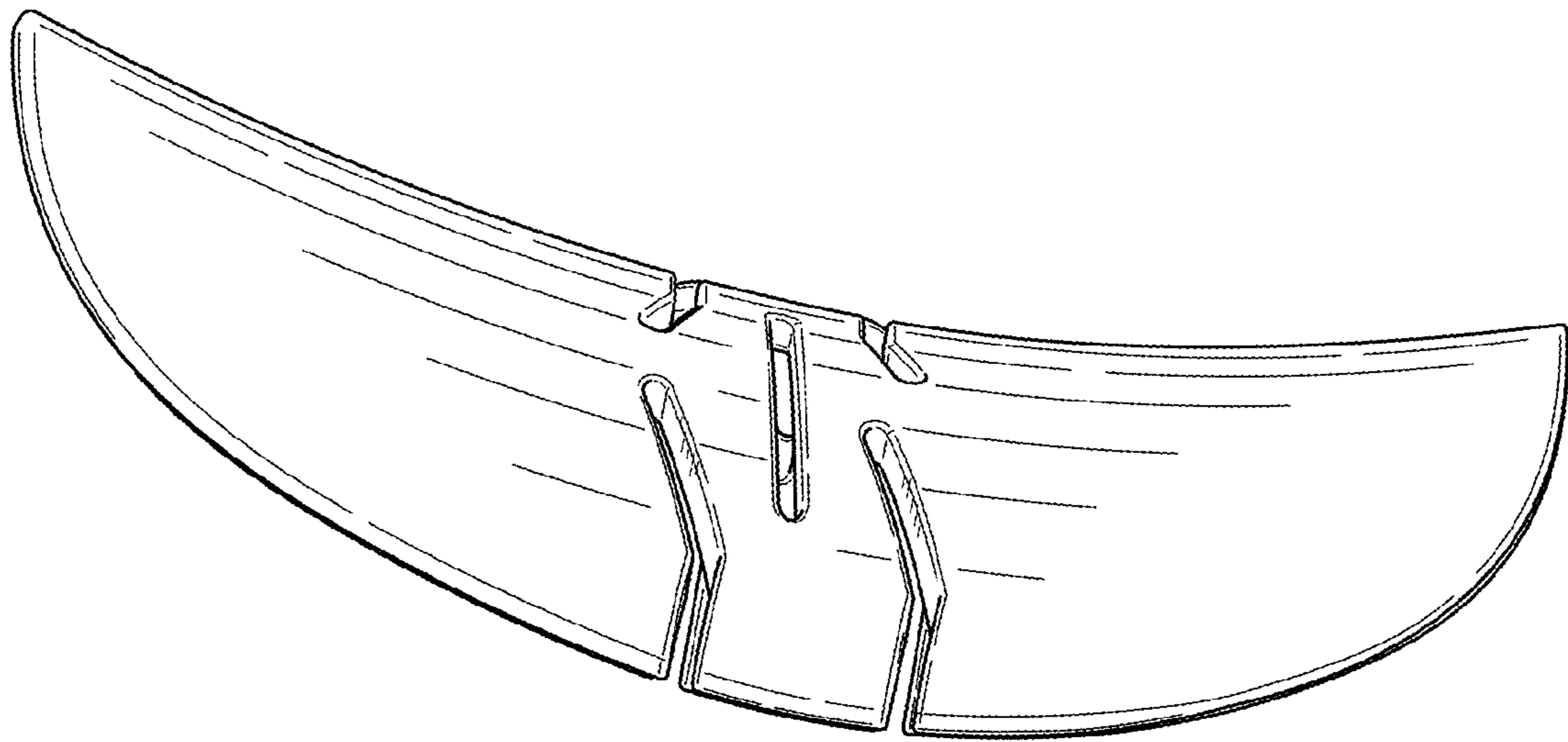

FIG. 4

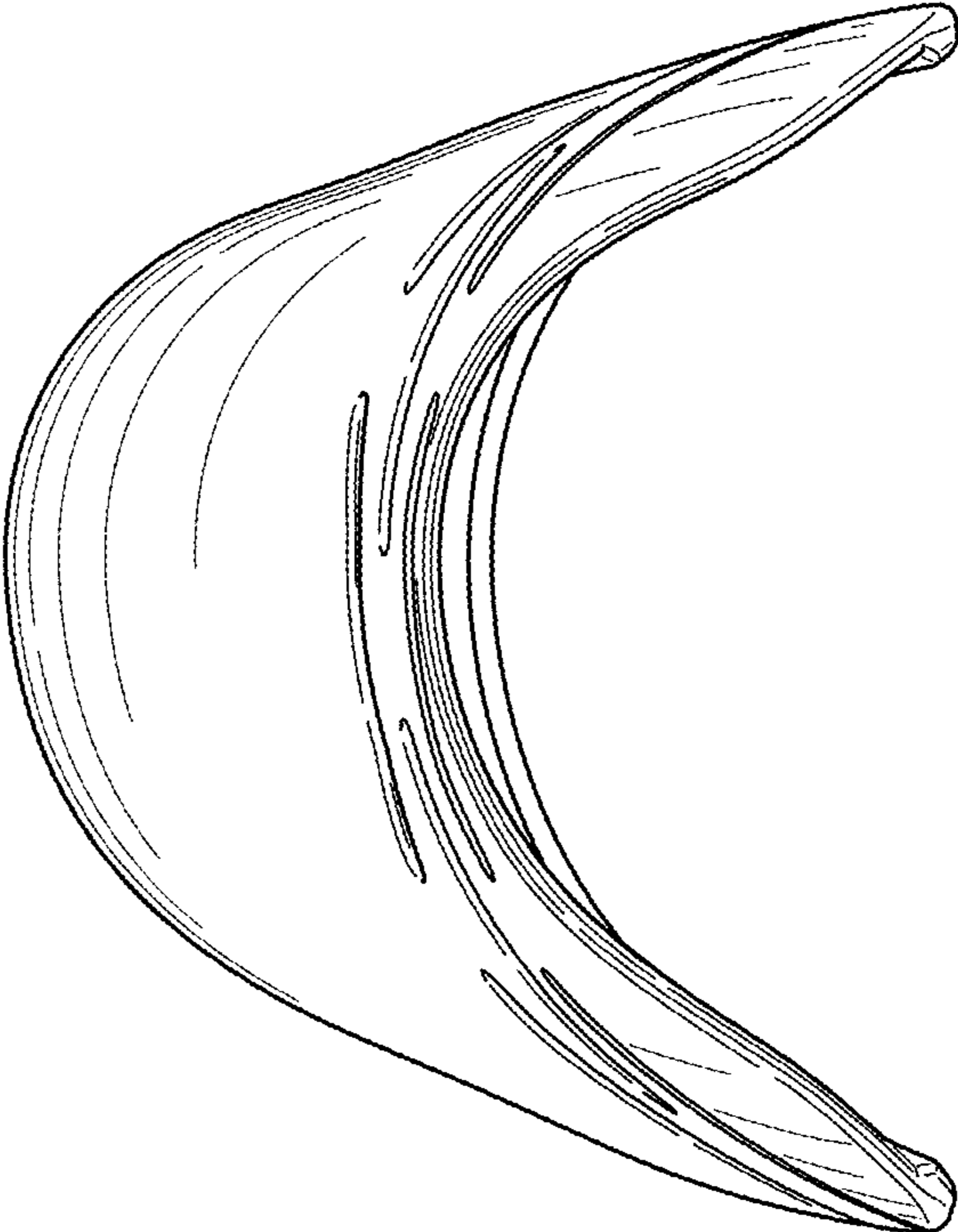

FIG. 6

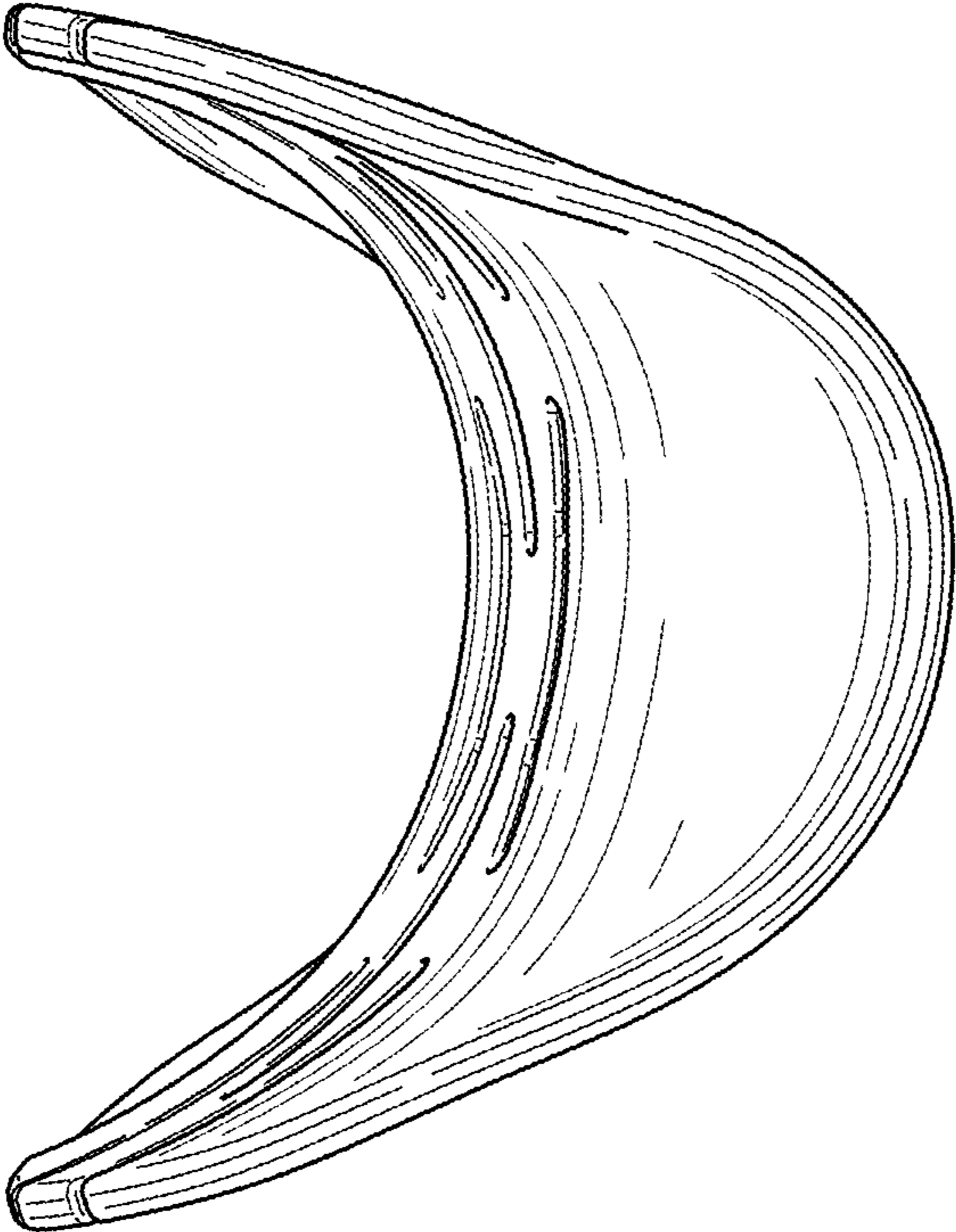

FIG. 7

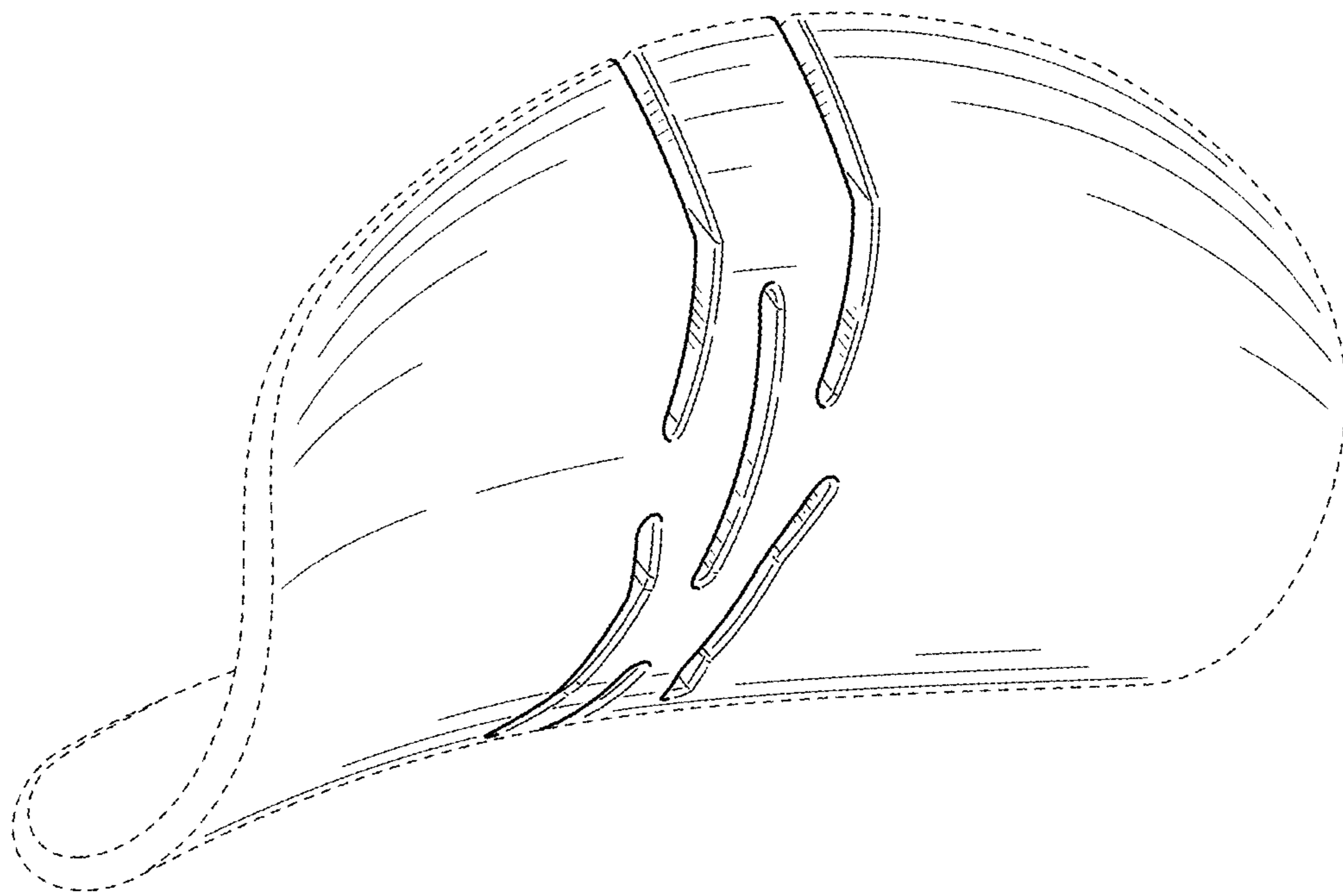

FIG. 8

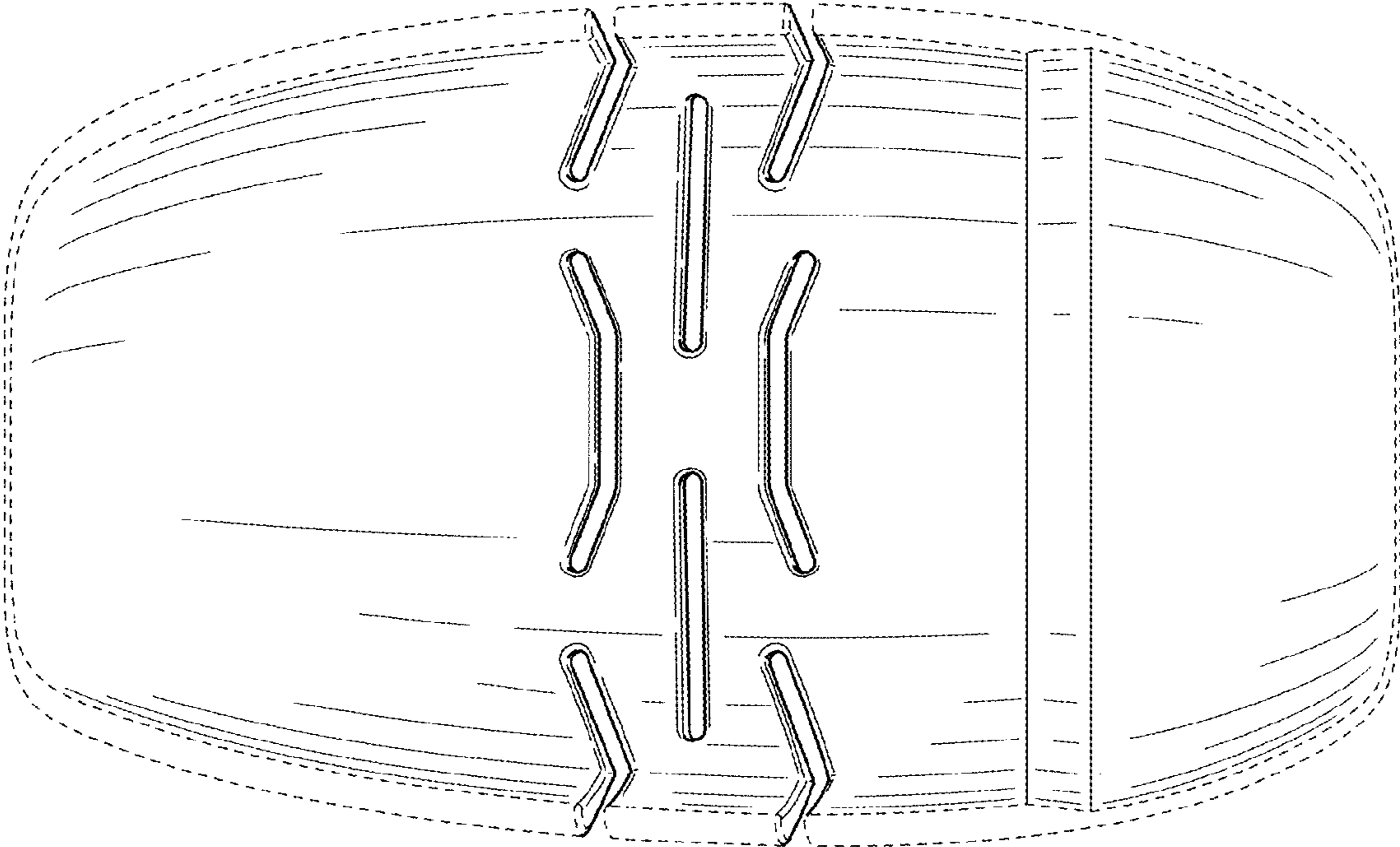

FIG. 9

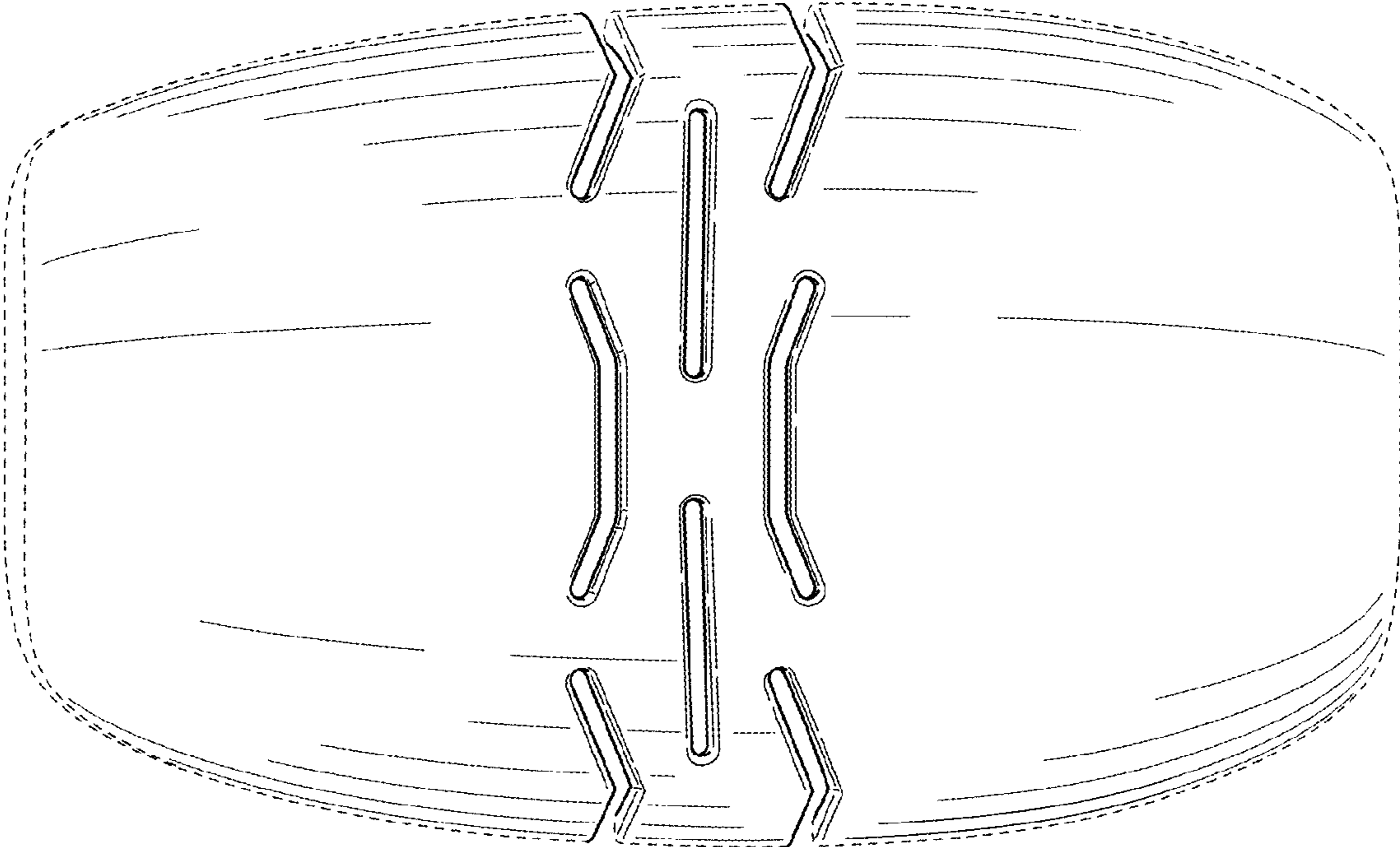

FIG. 10



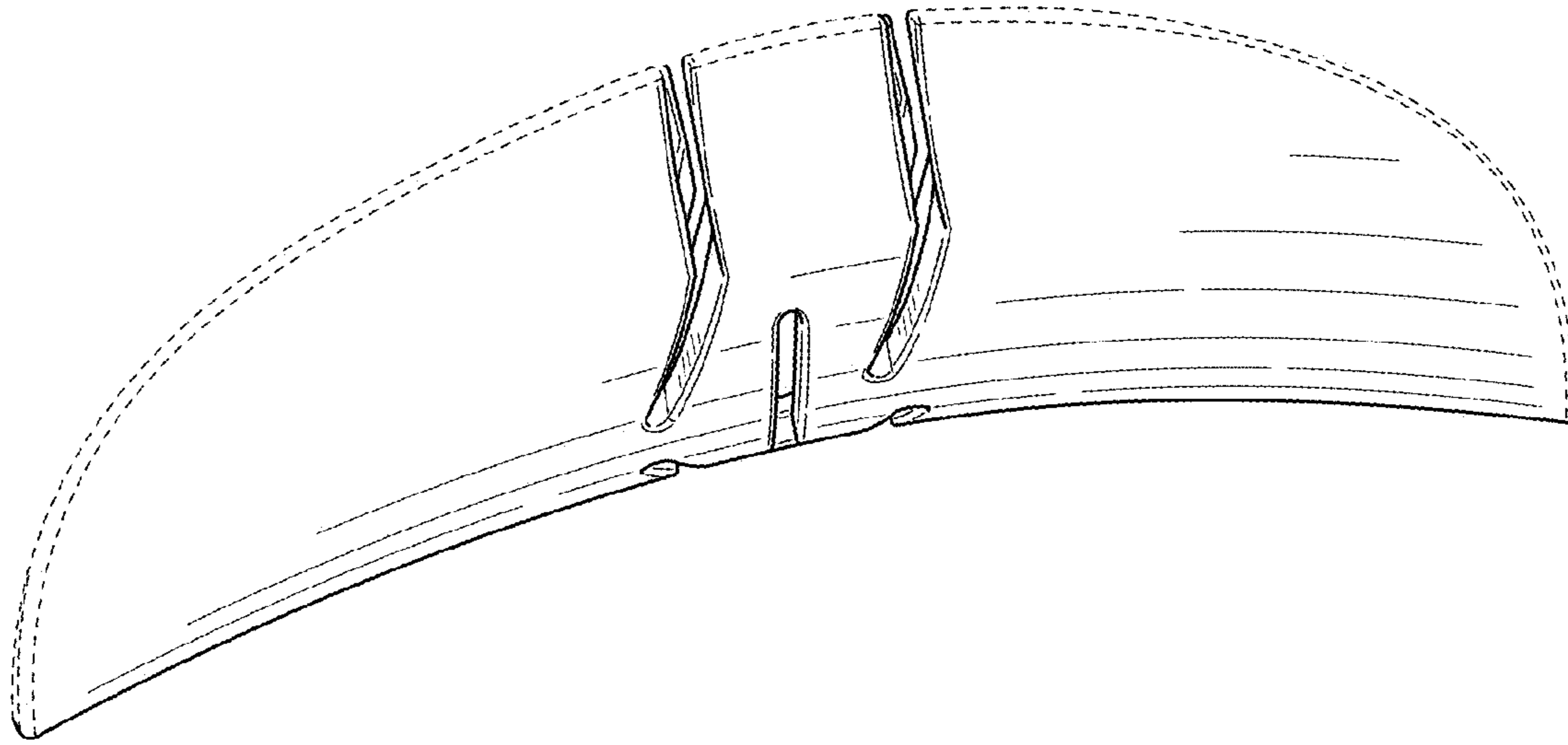

FIG. 12

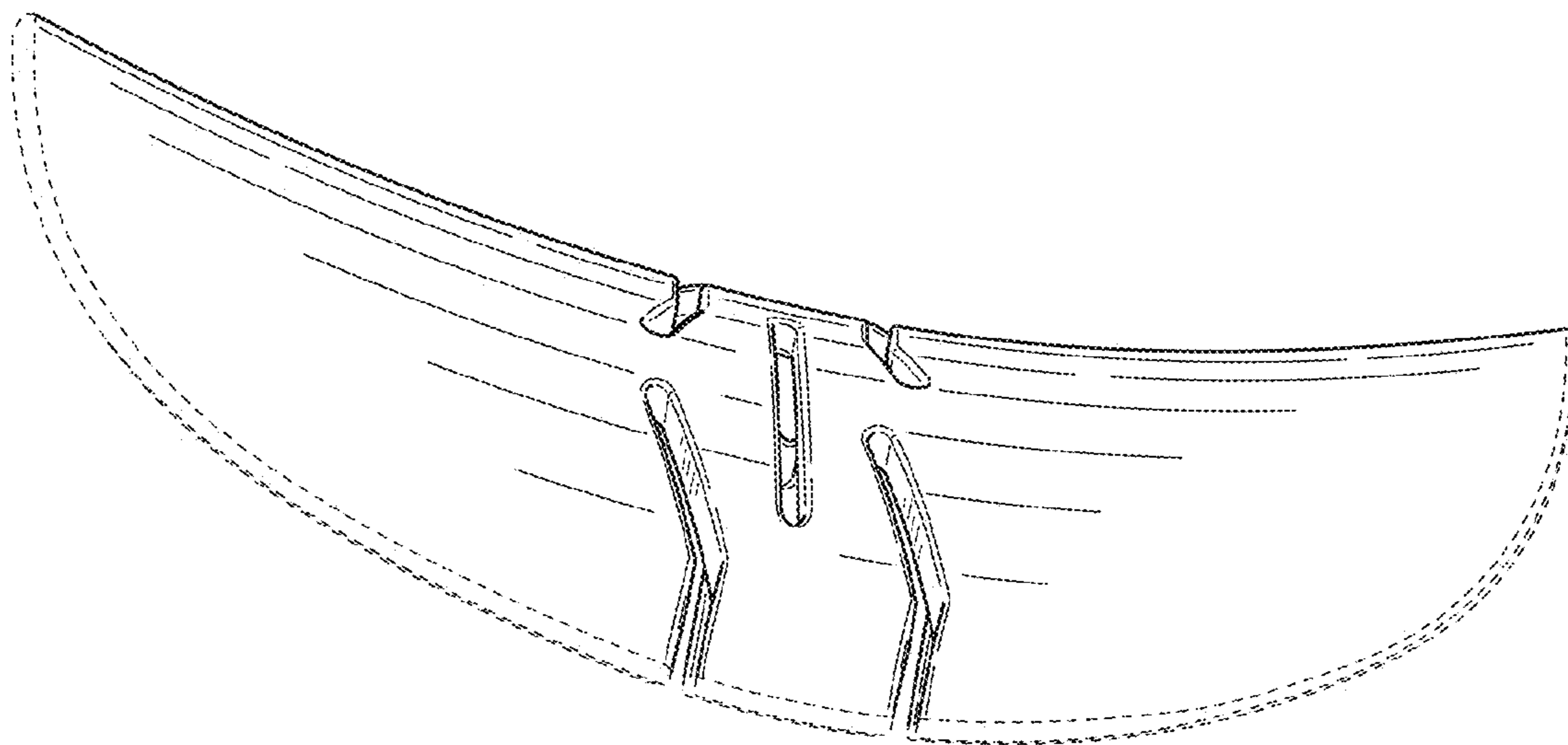

FIG. 11

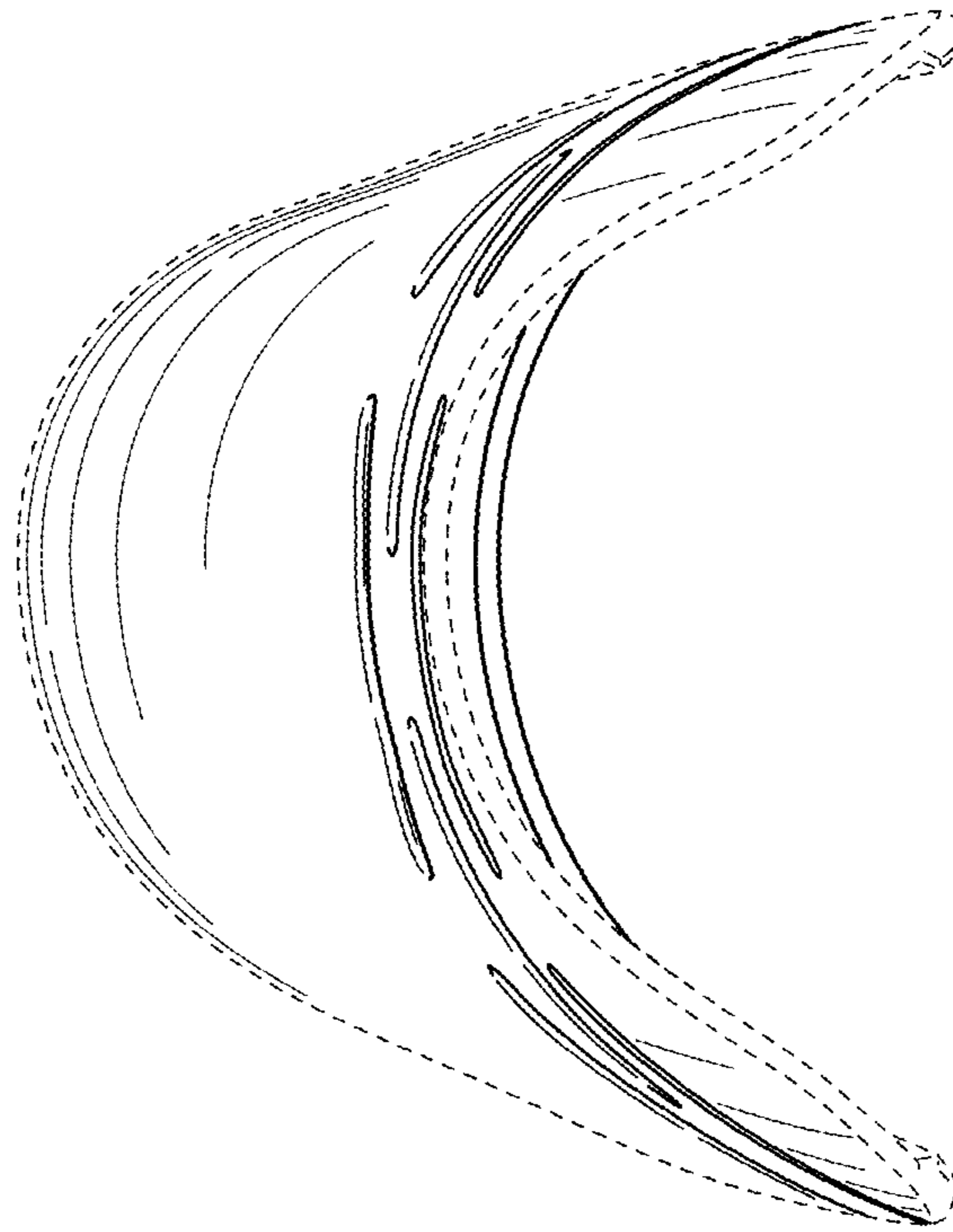

FIG. 14

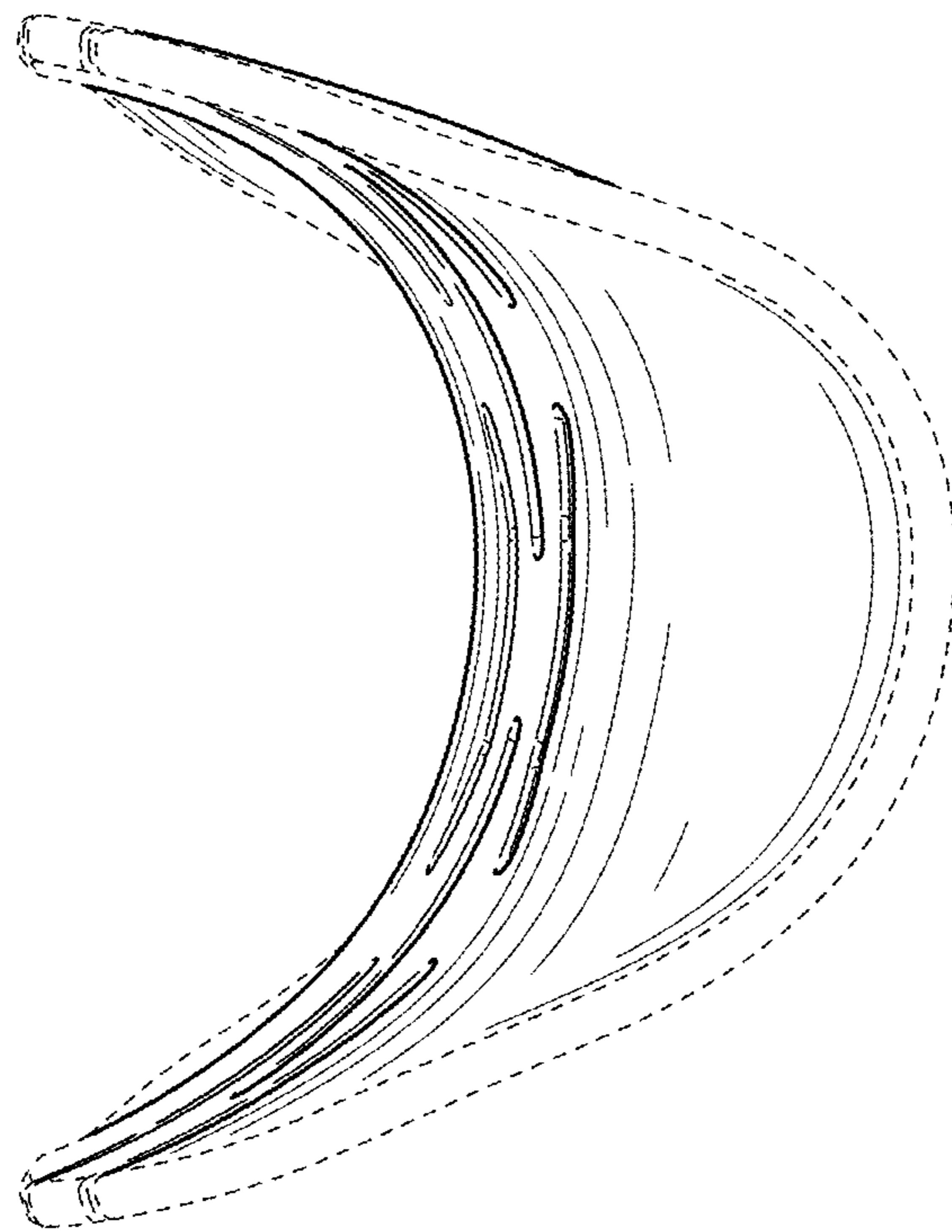

FIG. 13

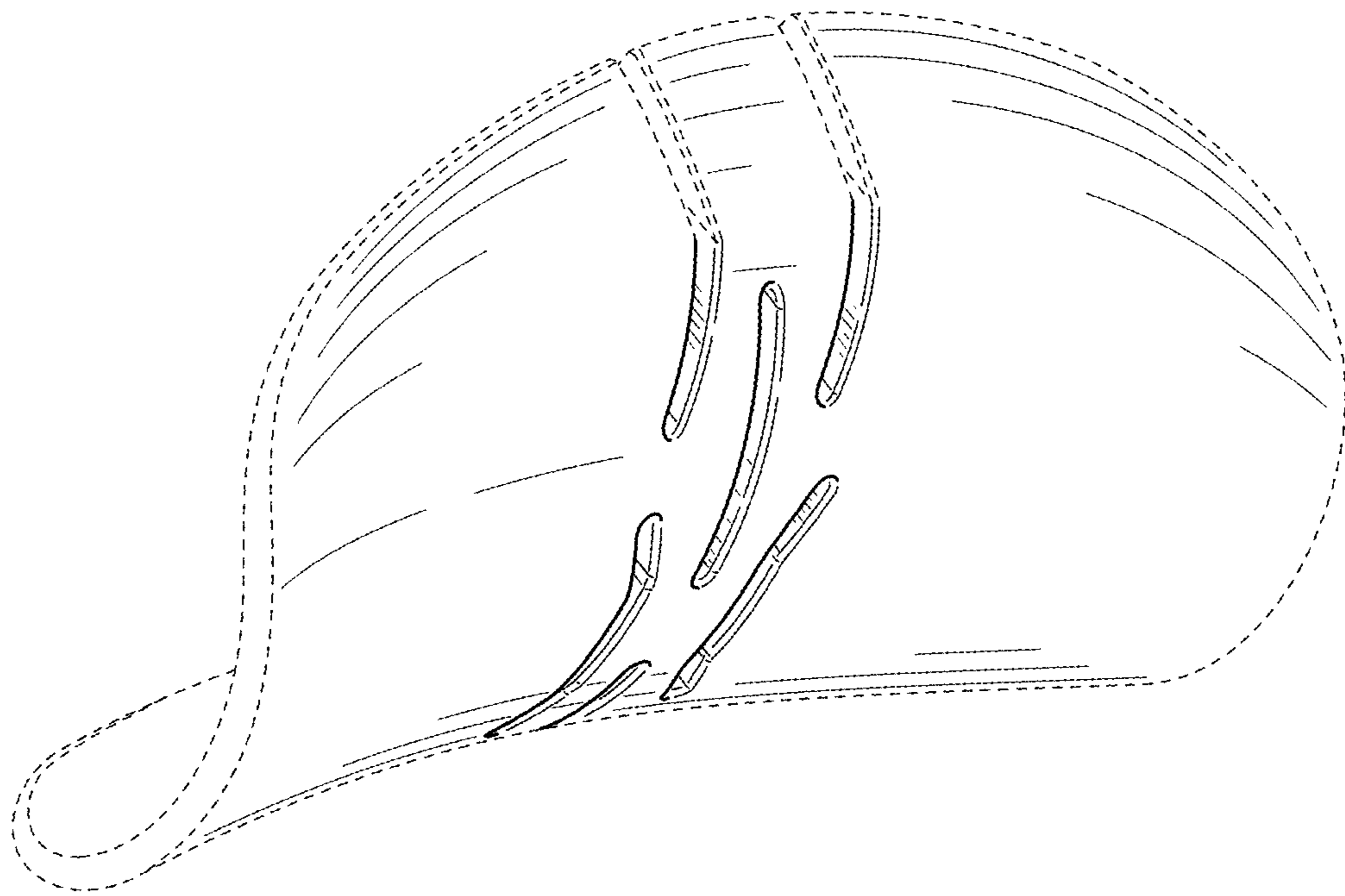

FIG. 15

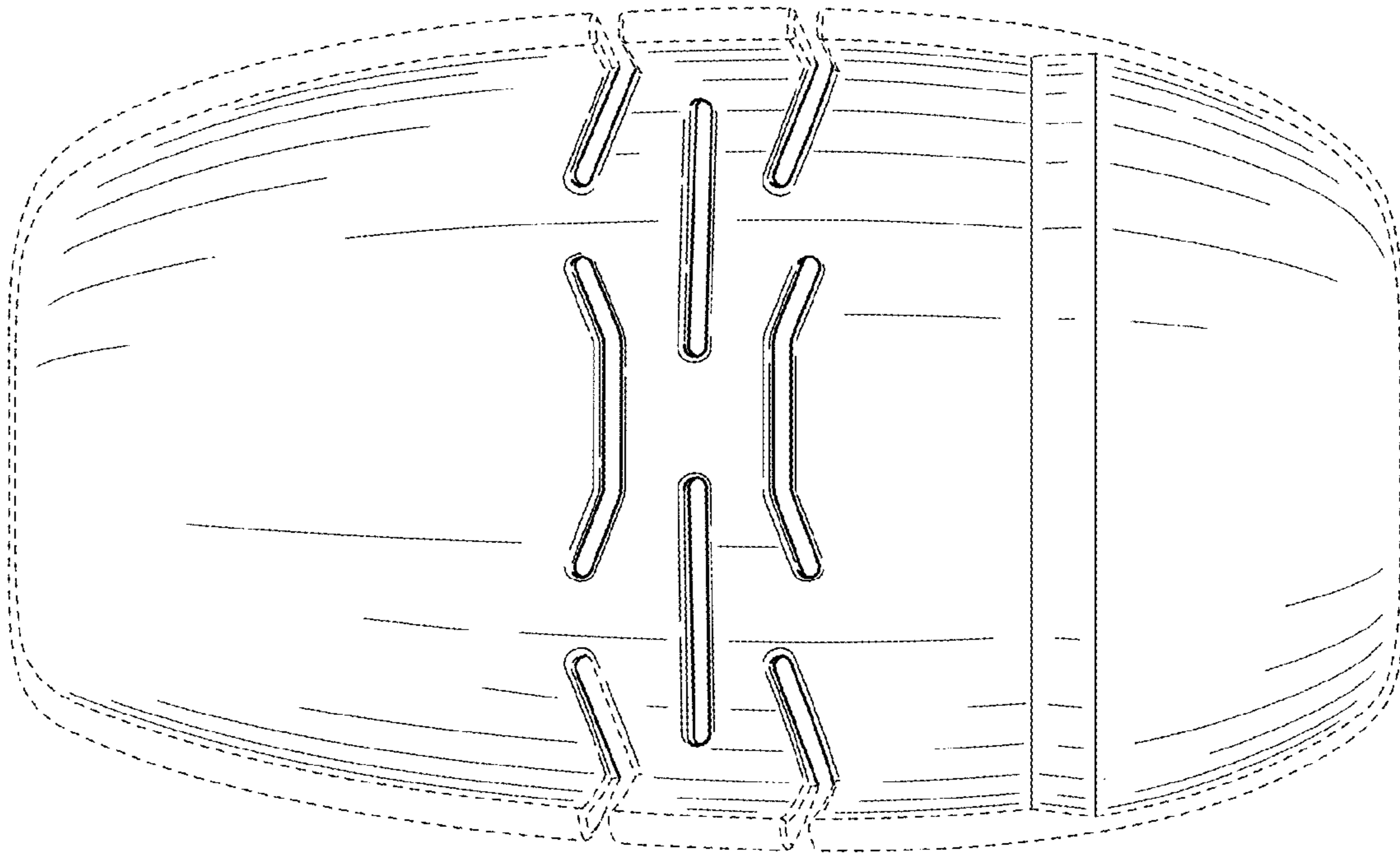

FIG. 17

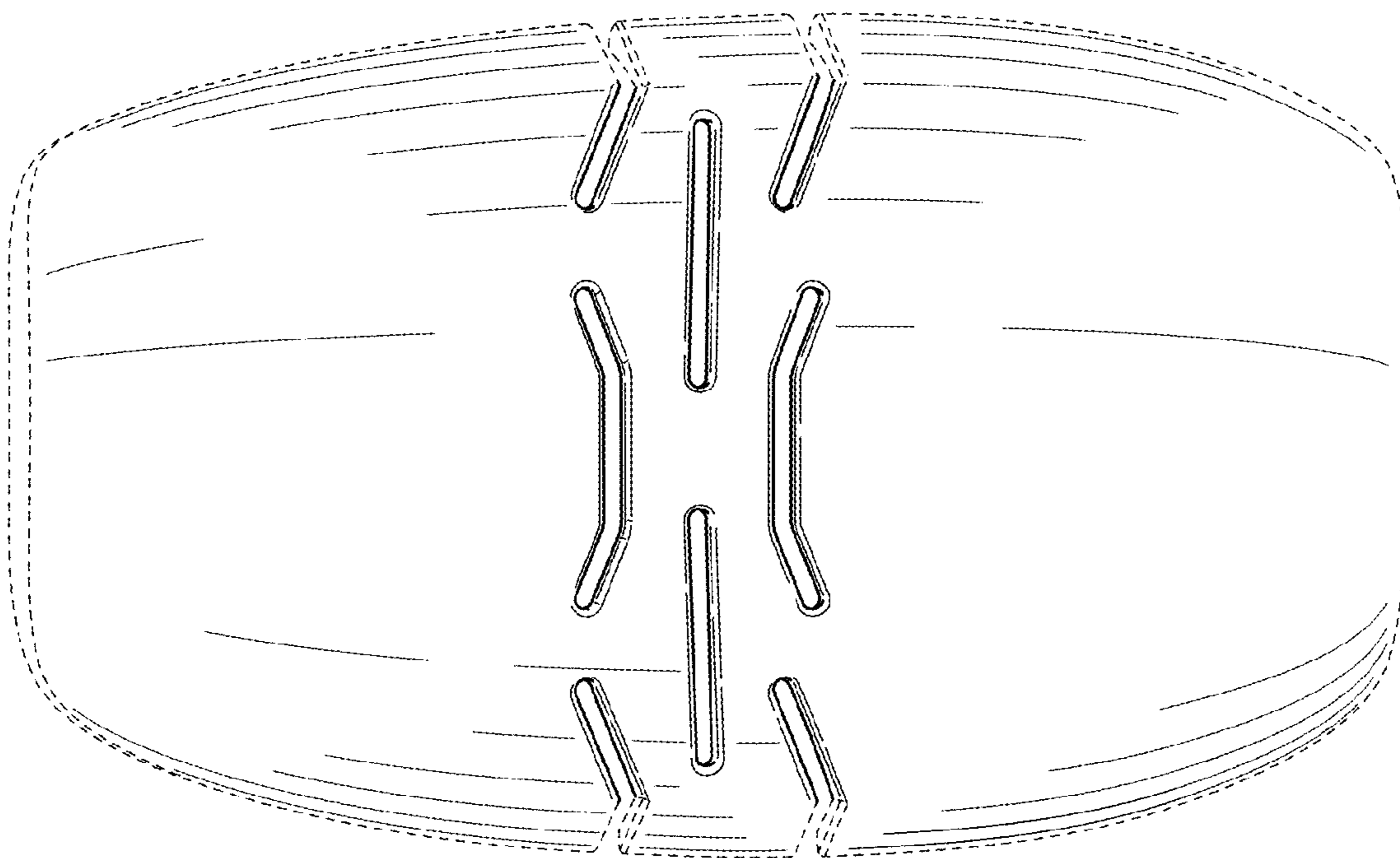

FIG. 16



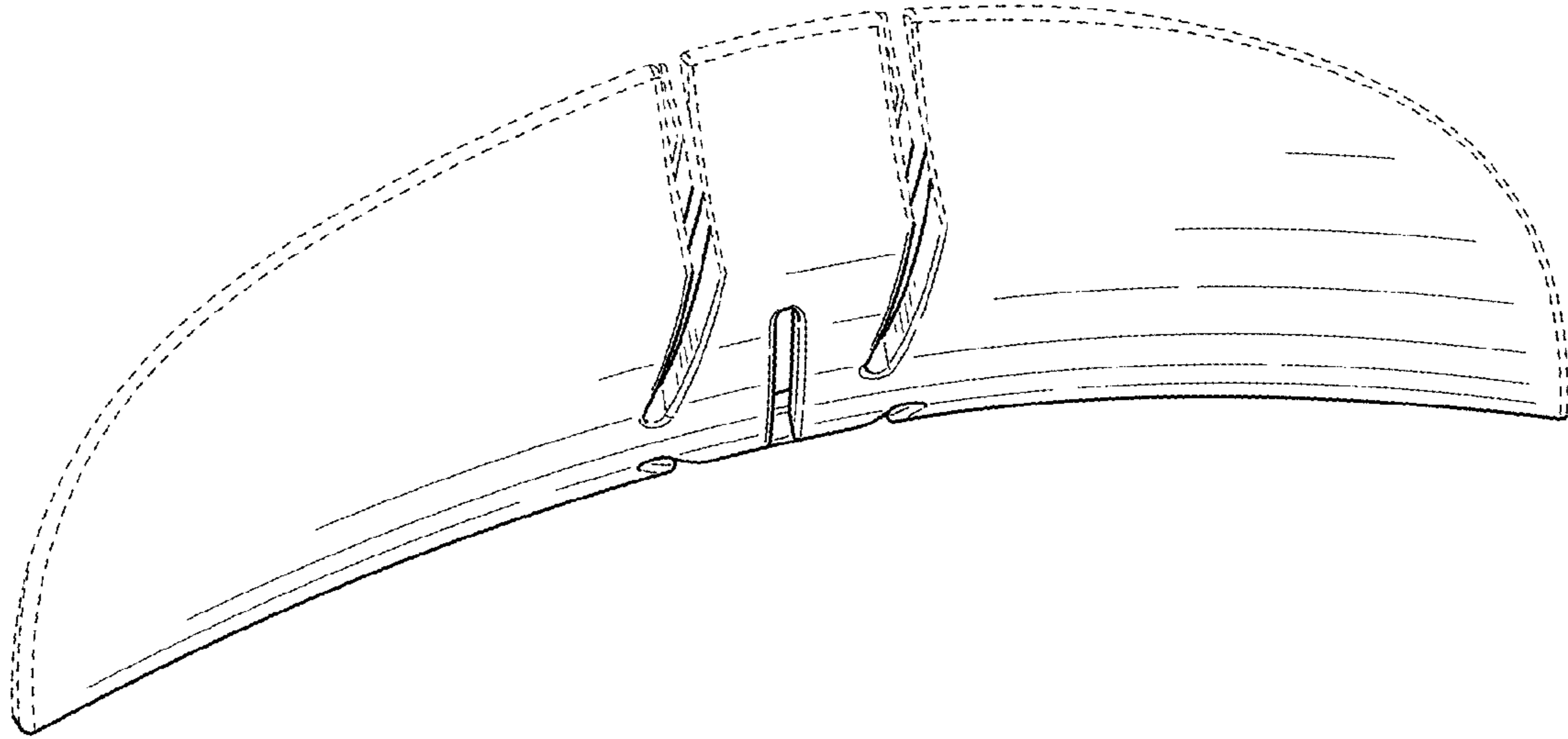

FIG. 19

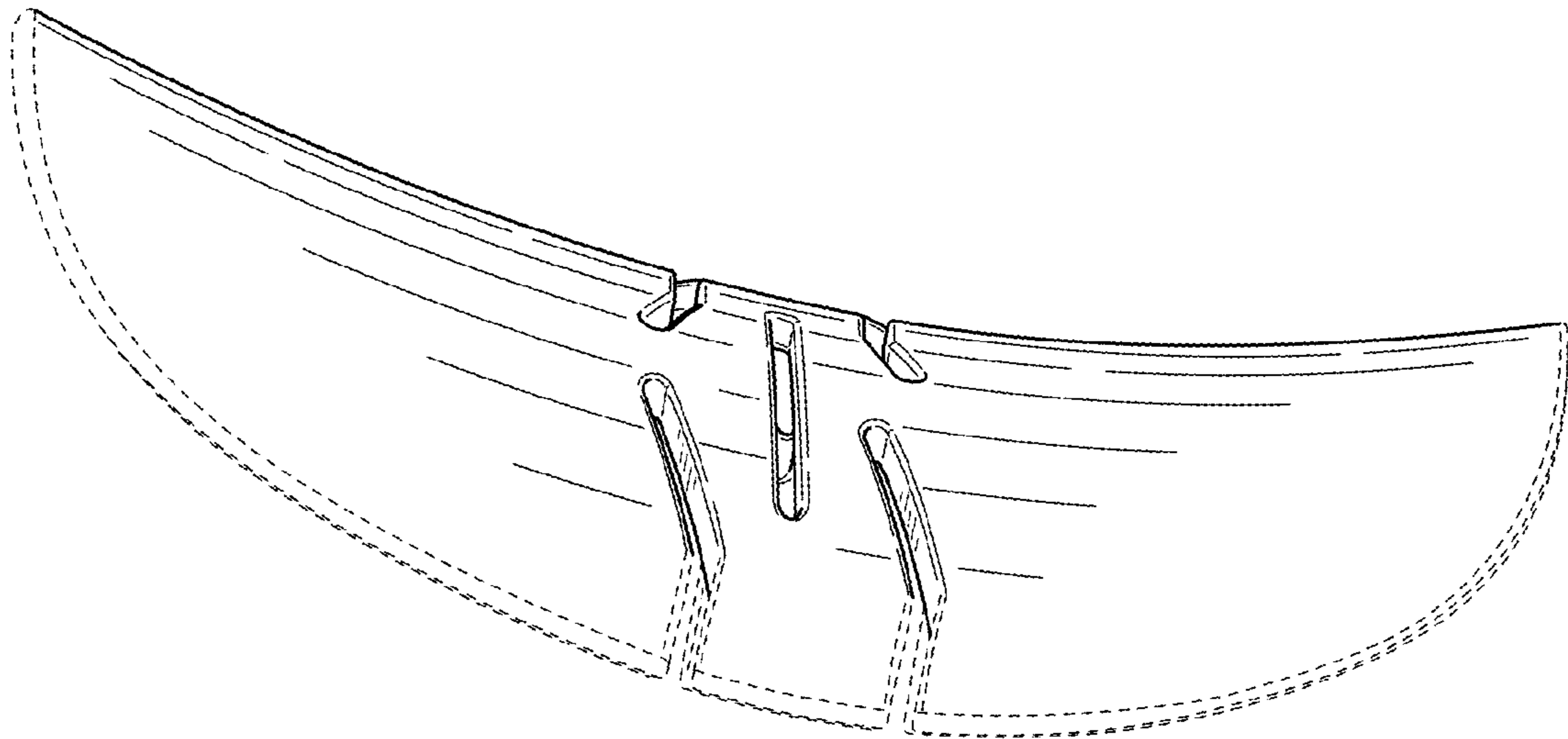

FIG. 18

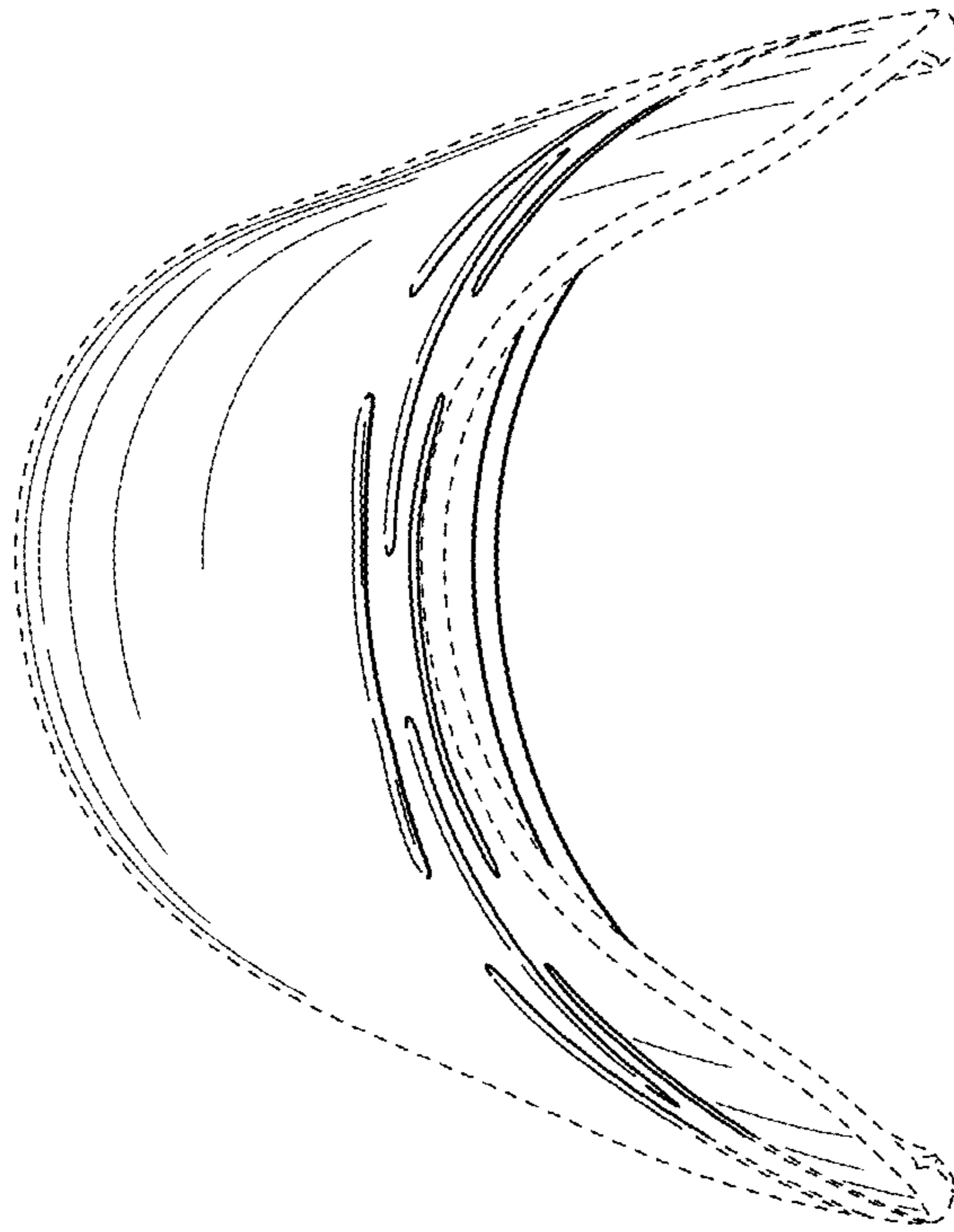

FIG. 21

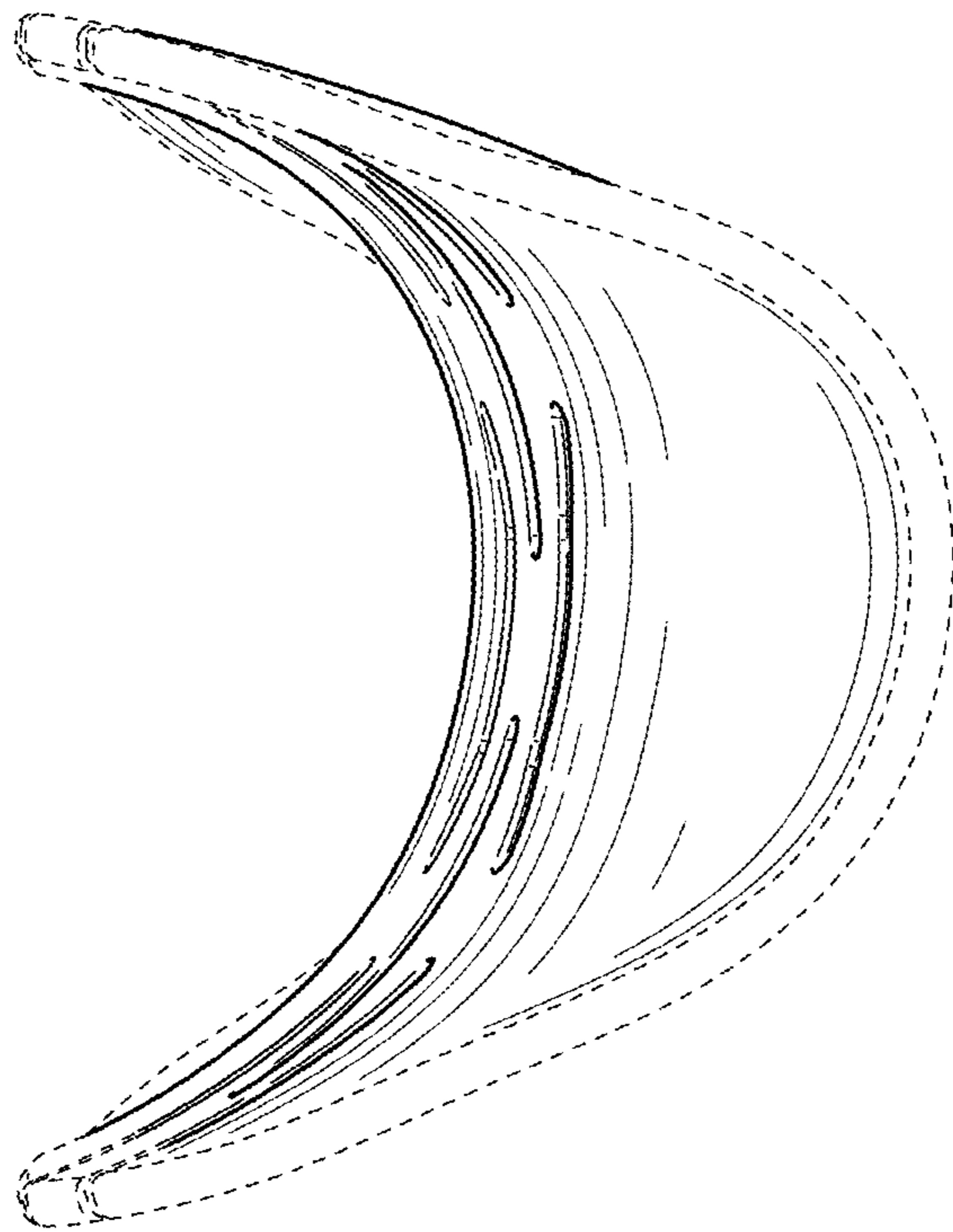

FIG. 20