



US00D876000S

(12) **United States Design Patent**  
**Yuan**

(10) **Patent No.:** **US D876,000 S**

(45) **Date of Patent:** **\*\* Feb. 18, 2020**

(54) **PROFILE OF BARREL LAMP BRACKET**

(71) Applicant: **Ningbo Hamming Optoelectronic Technology Co., Ltd., Ningbo (CN)**

(72) Inventor: **Yinghua Yuan, Ningbo (CN)**

(73) Assignee: **NINGBO HAMMING OPTOELECTRONIC TECHNOLOGY CO., LTD., Ningbo (CN)**

(\*\*) Term: **15 Years**

(21) Appl. No.: **29/657,231**

(22) Filed: **Jul. 20, 2018**

(30) **Foreign Application Priority Data**

Jan. 23, 2018 (CN) ..... 2018 3 0031342

(51) **LOC (12) Cl.** ..... **26-05**

(52) **U.S. Cl.**  
USPC ..... **D26/138**

(58) **Field of Classification Search**  
USPC ..... D26/72, 74, 76, 78-83, 85, 86, 88, 90,  
D26/93, 111, 113, 118, 119, 120, 121,  
D26/122, 138, 139, 140, 141, 142, 152  
CPC ..... F21S 2/00; F21S 4/00; F21S 4/003; F21S  
4/005; F21S 4/006; F21S 4/007; F21S  
4/008; F21S 6/00; F21S 8/00; F21S  
8/024; F21S 8/026; F21S 8/031; F21S  
8/033; F21S 8/035-037; F21S 8/04; F21S  
8/043; F21S 8/063  
See application file for complete search history.

(56) **References Cited**

**U.S. PATENT DOCUMENTS**

D361,153 S \* 8/1995 Fernandes ..... D13/155  
D384,178 S \* 9/1997 Costa ..... D26/76

D465,292 S \* 11/2002 Ko ..... D26/3  
D473,663 S \* 4/2003 Chou ..... D25/122  
D603,079 S \* 10/2009 Toot ..... D26/118  
D606,501 S \* 12/2009 Plonski ..... D13/179  
D625,463 S \* 10/2010 Klus ..... D26/138  
D632,655 S \* 2/2011 Heyman ..... D13/153  
D634,876 S \* 3/2011 McGrath ..... D26/79  
D641,923 S \* 7/2011 Radchenko ..... D26/138  
D649,688 S \* 11/2011 Trzesniowski ..... D26/138  
D656,632 S \* 3/2012 Lai ..... D26/3  
D698,075 S \* 1/2014 Klus ..... D26/138  
D747,031 S \* 1/2016 Edwards ..... D26/138  
D759,887 S \* 6/2016 Seehof ..... D26/118  
D781,485 S \* 3/2017 Bouroullec ..... D26/88  
D792,632 S \* 7/2017 Amato ..... D26/90  
D793,000 S \* 7/2017 Sonneman ..... D26/113  
D833,056 S \* 11/2018 Sonneman ..... D26/86  
D856,574 S \* 8/2019 Trzcielinski ..... D26/138

\* cited by examiner

*Primary Examiner* — Natasha Vujcic

(74) *Attorney, Agent, or Firm* — Bayramoglu Law Offices LLC

(57) **CLAIM**

The ornamental design for a profile of barrel lamp bracket, as shown and described.

**DESCRIPTION**

FIG. 1 is a front view of a profile of barrel lamp bracket showing the new design;  
FIG. 2 is a rear view thereof;  
FIG. 3 is a left side view thereof;  
FIG. 4 is a right side view thereof;  
FIG. 5 is a top view thereof;  
FIG. 6 is a bottom view thereof; and,  
FIG. 7 is a perspective view thereof.  
The break lines in drawings indicate that the appearance of any portion of the profile of barrel lamp bracket between the break lines forms no part of the claimed design.

**1 Claim, 6 Drawing Sheets**

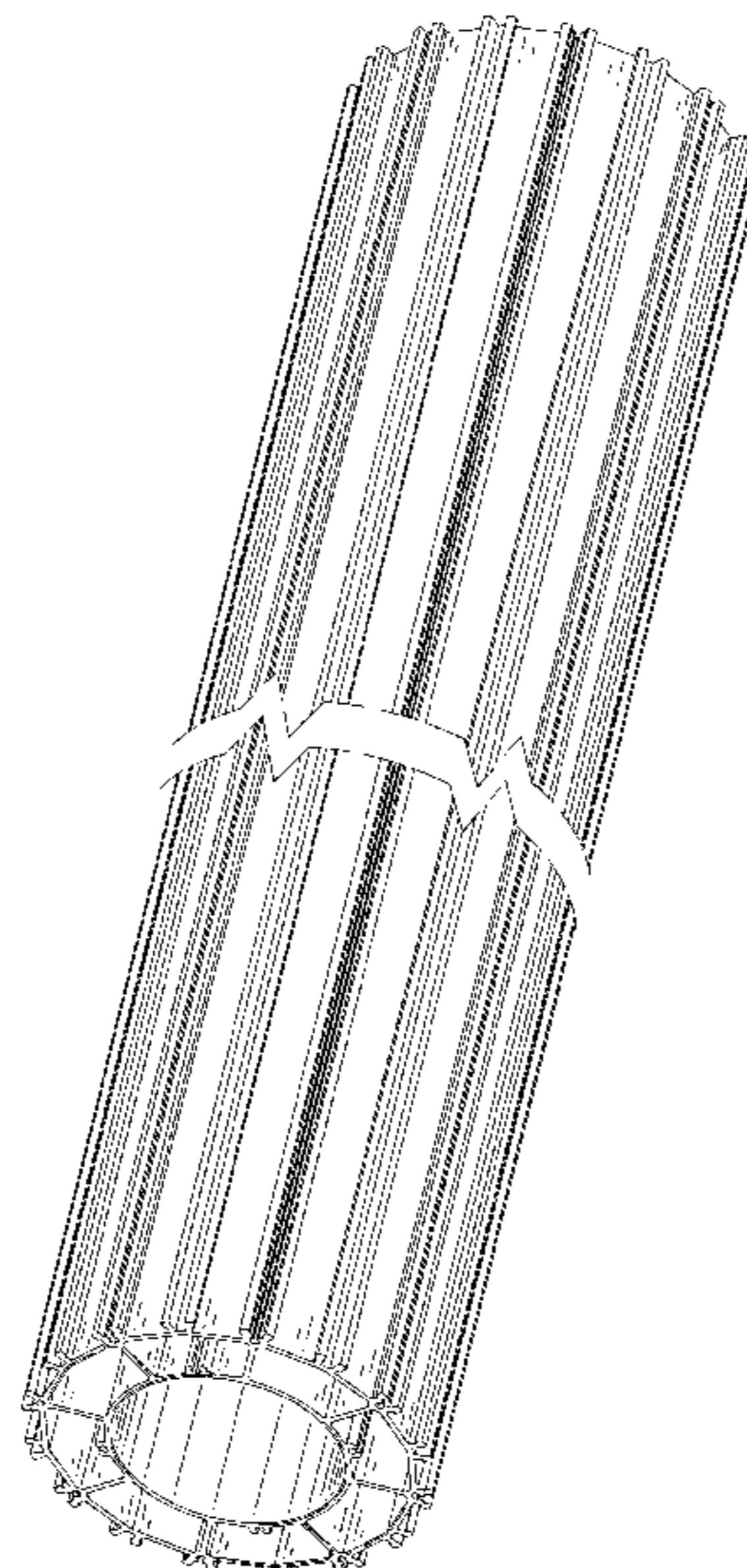

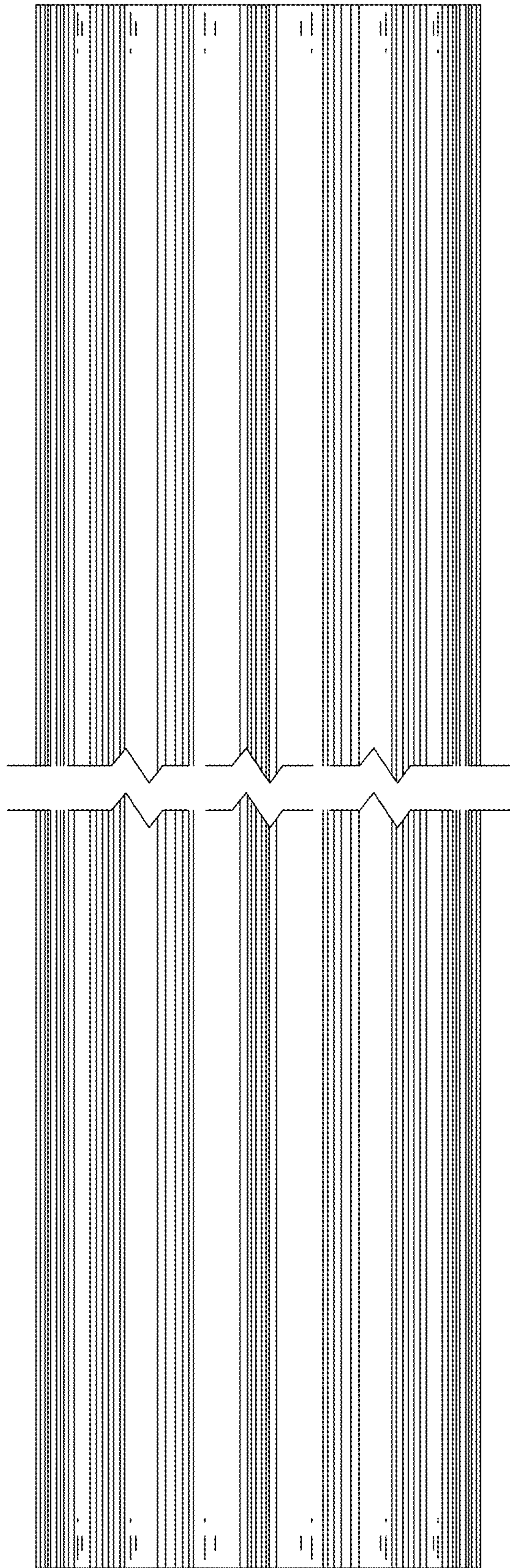

Fig. 1

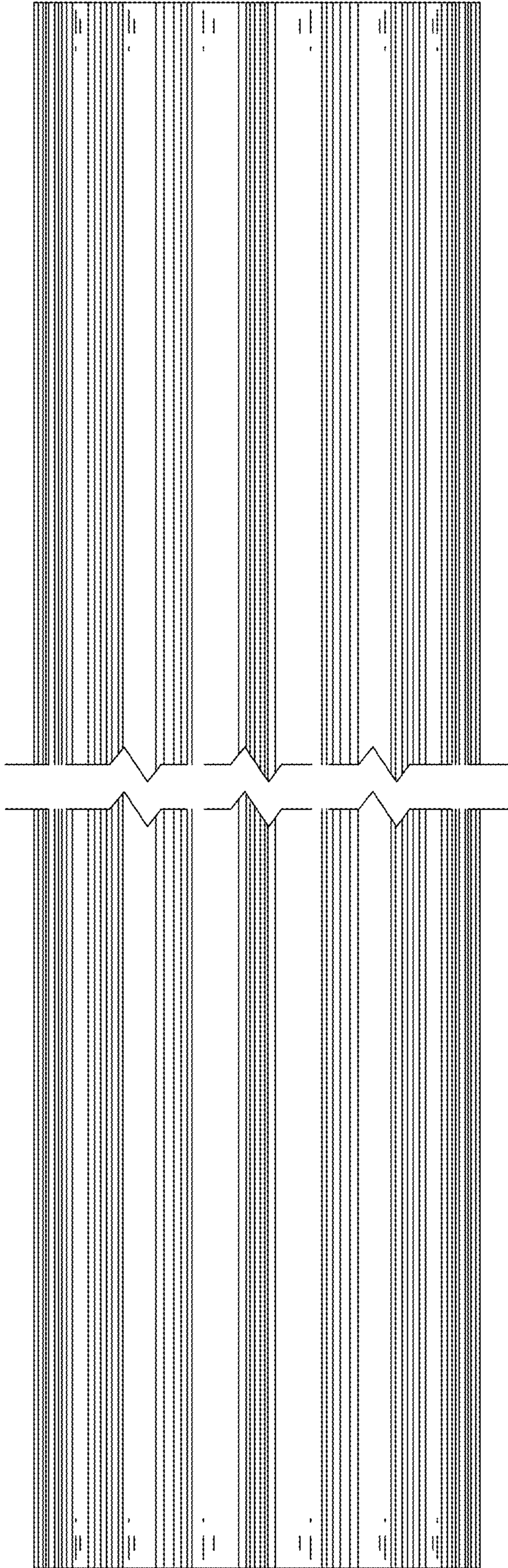

Fig. 2

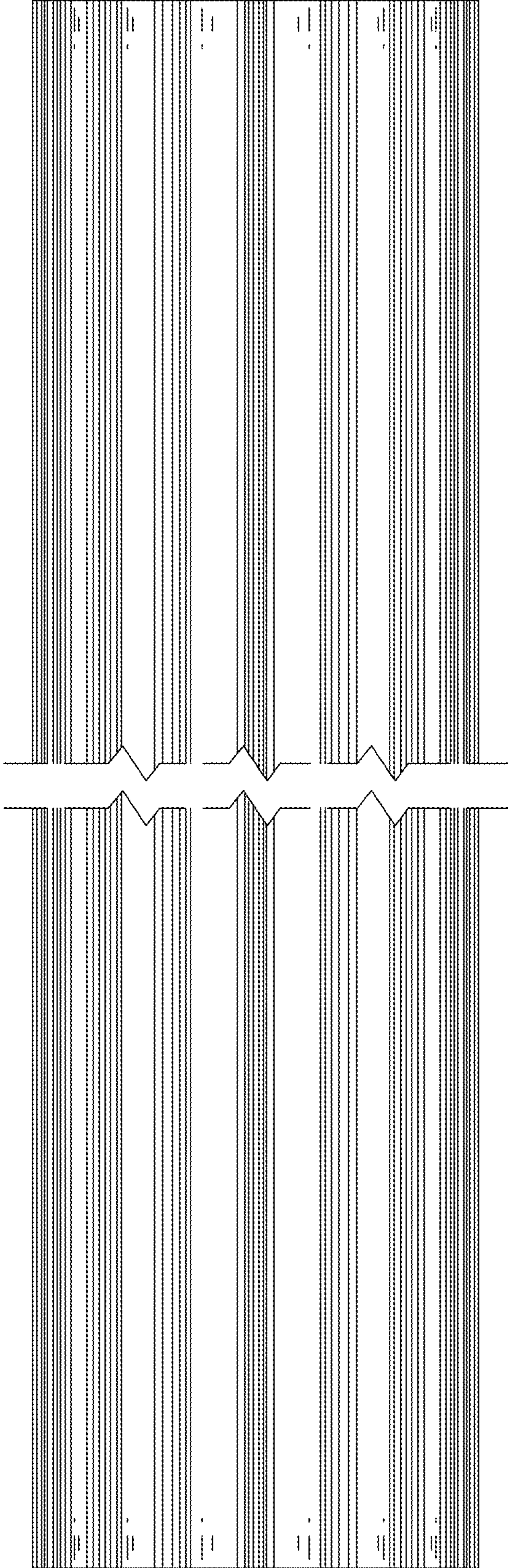

Fig. 3

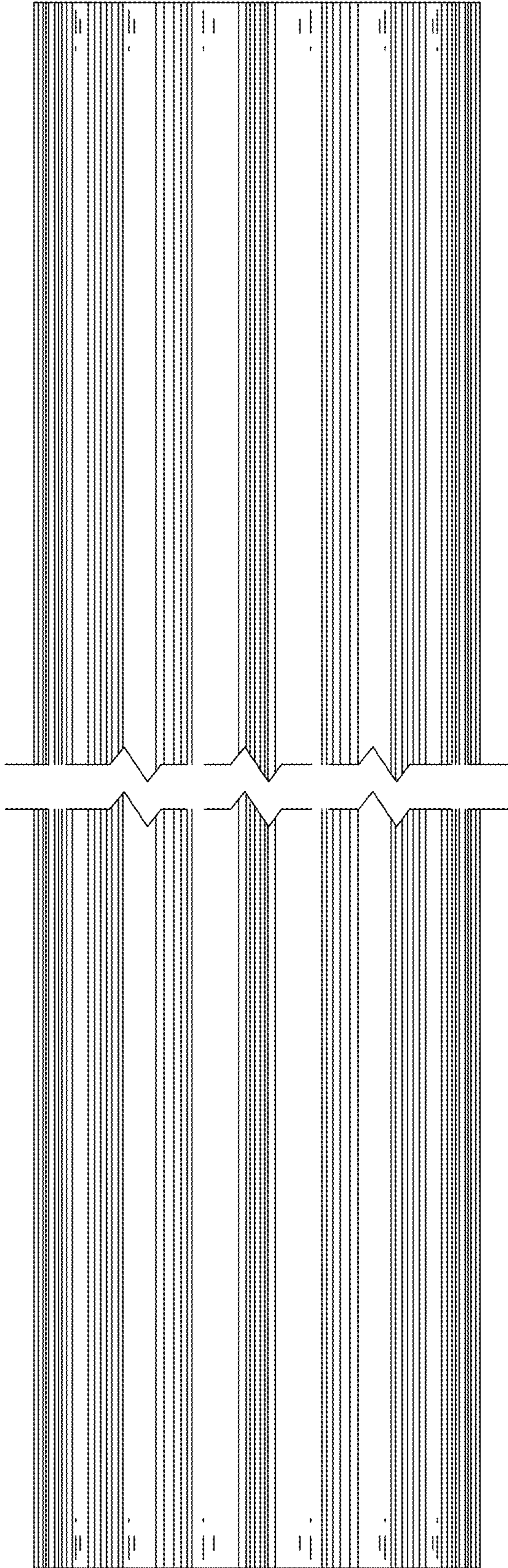

Fig. 4

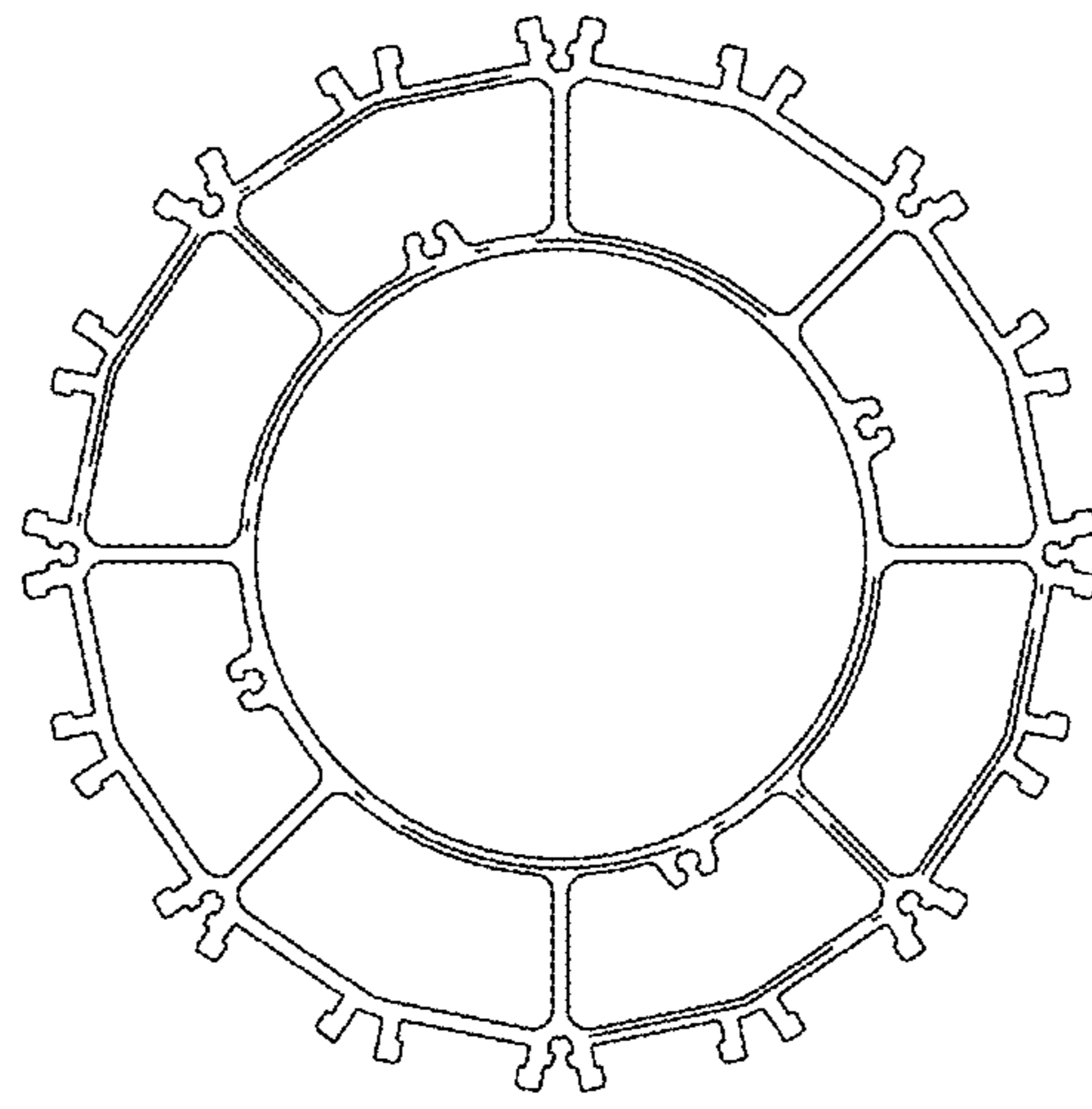

Fig. 5

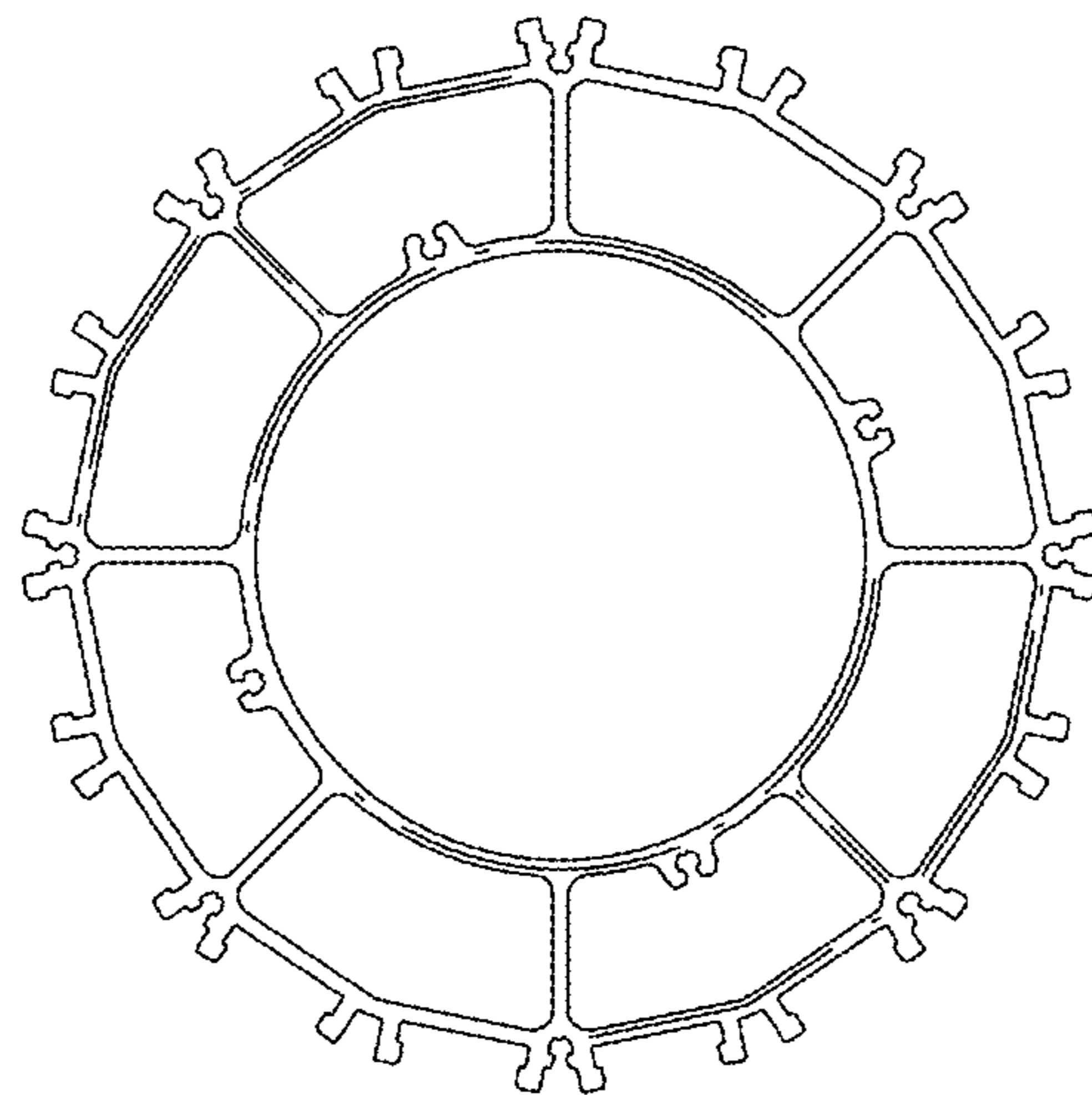

Fig. 6

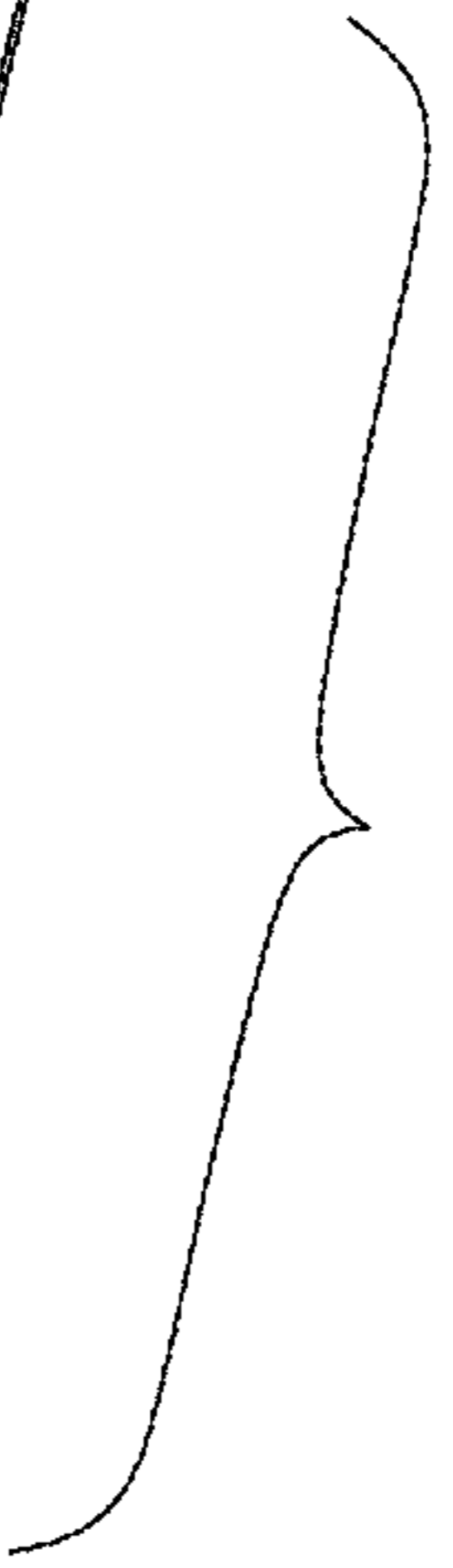
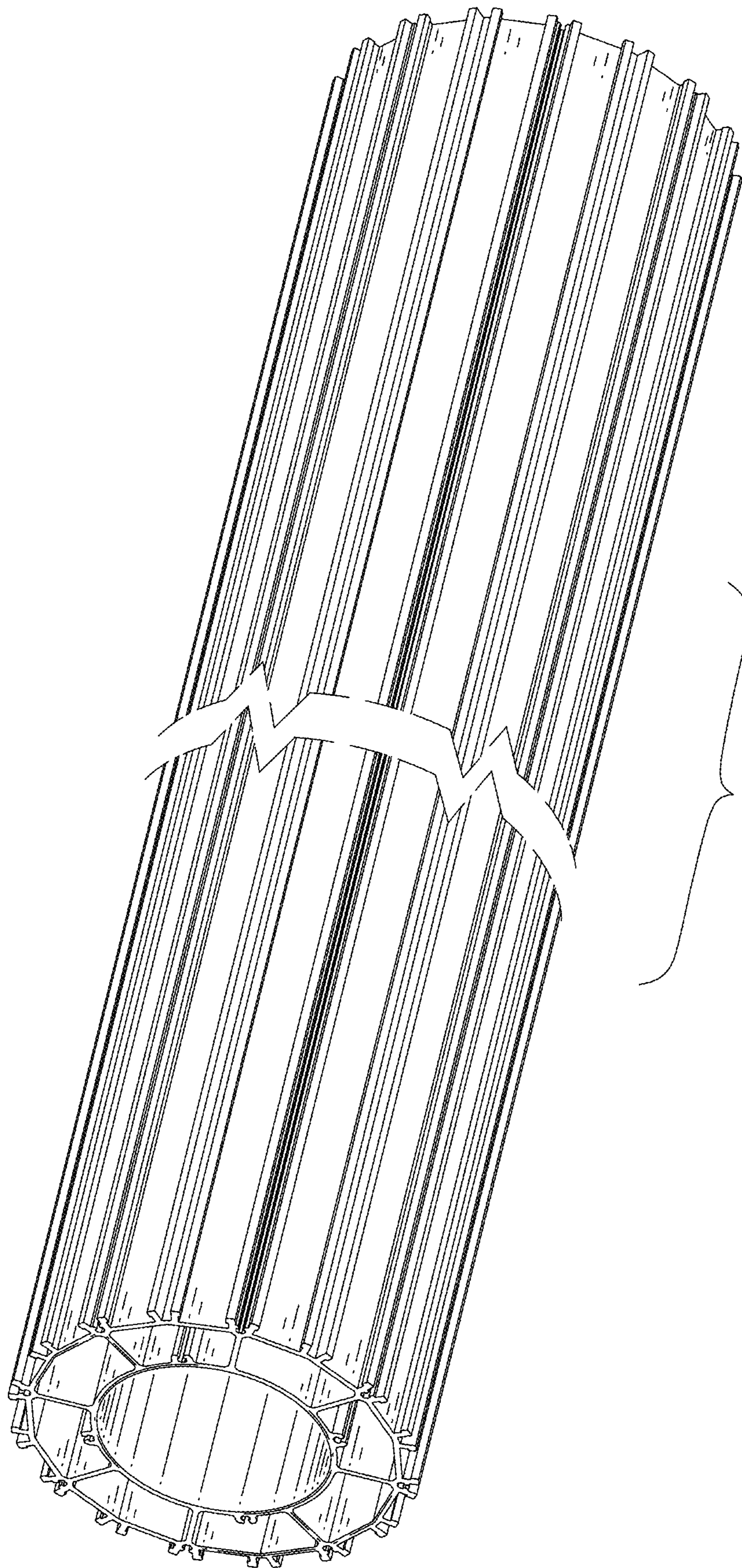

Fig. 7