



US00D875907S

(12) **United States Design Patent**  
**Jiang**

(10) **Patent No.:** **US D875,907 S**

(45) **Date of Patent:** **\*\* Feb. 18, 2020**

(54) **BIDET**

CPC ..... A47K 13/00; A47K 13/05  
See application file for complete search history.

(71) Applicants: **XIAMEN SOOTHINGWARE  
SANITARY CO., LTD.**, Xiamen (CN);  
**BBC INNOVATION  
CORPORATION**, Crystal Lake, IL  
(US)

(56) **References Cited**

U.S. PATENT DOCUMENTS

7,896,298 B2 \* 3/2011 Meyers ..... A61M 5/1415  
248/124.1  
2016/0010319 A1 \* 1/2016 Willers ..... E03D 9/08  
4/448

\* cited by examiner

(72) Inventor: **Jian Bing Jiang**, Xiamen (CN)

*Primary Examiner* — Robert A Delehanty

(73) Assignees: **Xiamen Soothingware Sanitary Co.,  
Ltd.**, Xiamen, Fujian Prov. (CN); **BBC  
Innovation Corporation**, Crystal Lake,  
IL (US)

(74) *Attorney, Agent, or Firm* — Rosenberg, Klein & Lee

(57) **CLAIM**

The ornamental design for a bidet, as shown and described.

**DESCRIPTION**

(\*\*) Term: **15 Years**

FIG. 1 is a top-front perspective view of a bidet showing the new design;  
FIG. 2 is a top-rear perspective view thereof;  
FIG. 3 is a top elevational view thereof;  
FIG. 4 is a left-side elevational view thereof;  
FIG. 5 is a right-side elevational view thereof;  
FIG. 6 is a rear elevational view thereof;  
FIG. 7 is a front elevational view thereof;  
FIG. 8 is an enlarged partial view of FIG. 3;  
FIG. 9 is a view of FIG. 8 in an operational state;  
FIG. 10 is a view of FIG. 8 in an operational state;  
FIG. 11 is a view of FIG. 8 in an operational state;  
FIG. 12 is a view of FIG. 8 in an operational state;  
FIG. 13 is a view of FIG. 8 in an operational state;  
FIG. 14 is an enlarged partial view of FIG. 1; and,  
FIG. 15 is an enlarged partial view of FIG. 2.

(21) Appl. No.: **29/662,177**

The broken lines in the figures depict environmental subject matter and form no part of the claimed design.

(22) Filed: **Sep. 4, 2018**

(30) **Foreign Application Priority Data**

Jun. 19, 2018 (CN) ..... 2018 3 0312649

(51) **LOC (12) Cl.** ..... **23-01**

(52) **U.S. Cl.**  
USPC ..... **D23/309**

(58) **Field of Classification Search**  
USPC ..... D23/303, 309–312, 295, 299

**1 Claim, 15 Drawing Sheets**

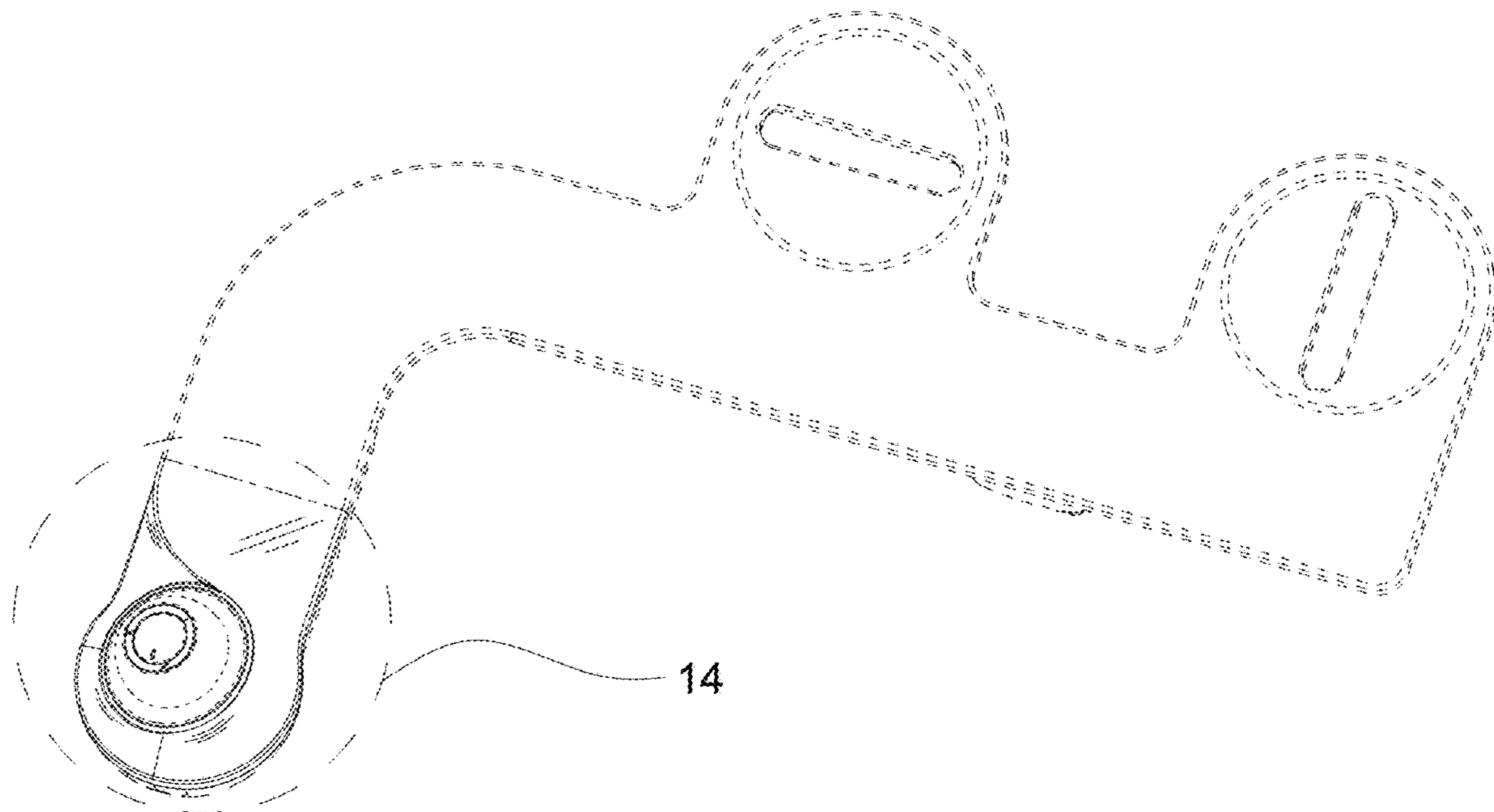

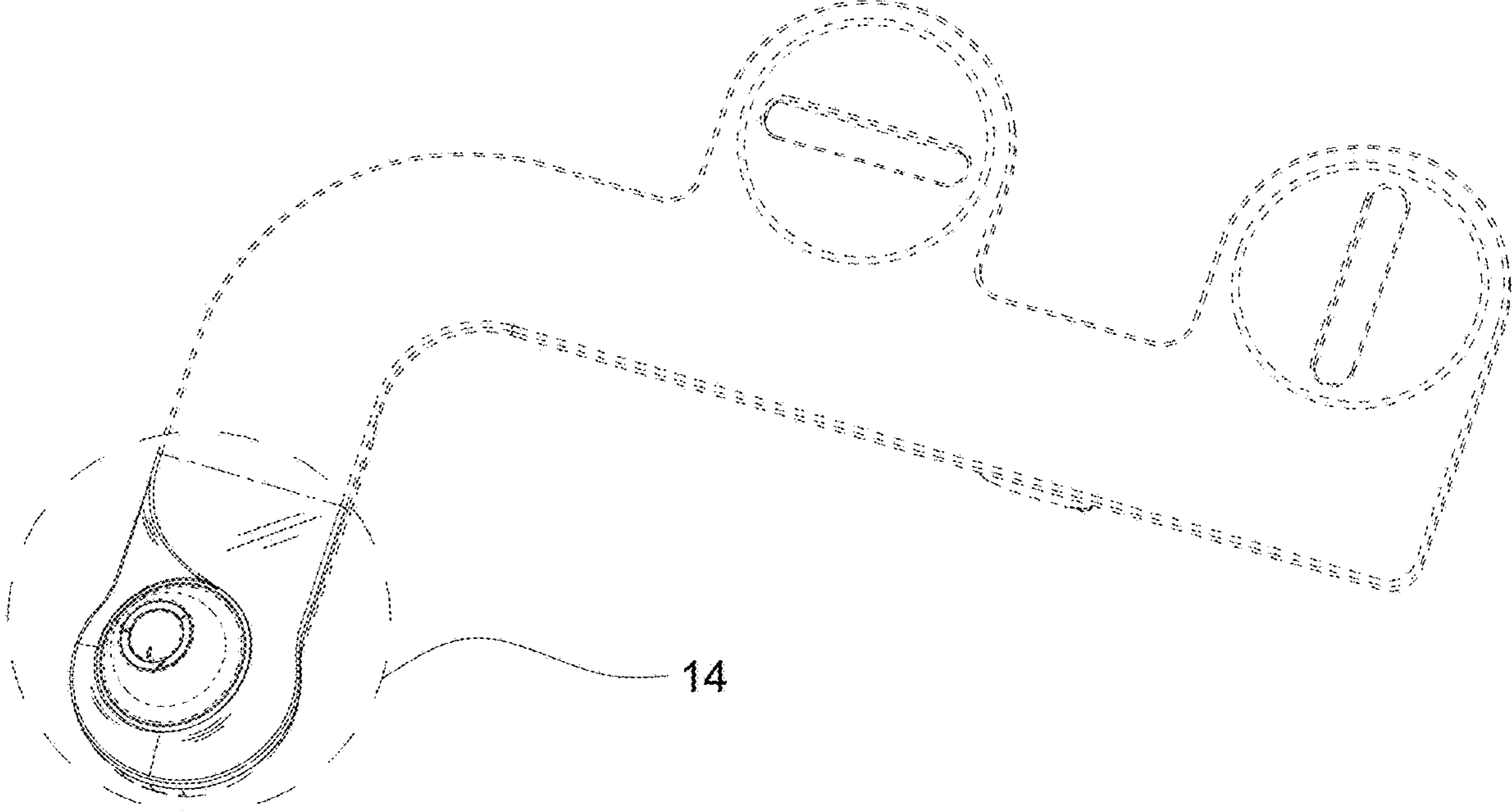

FIG.1

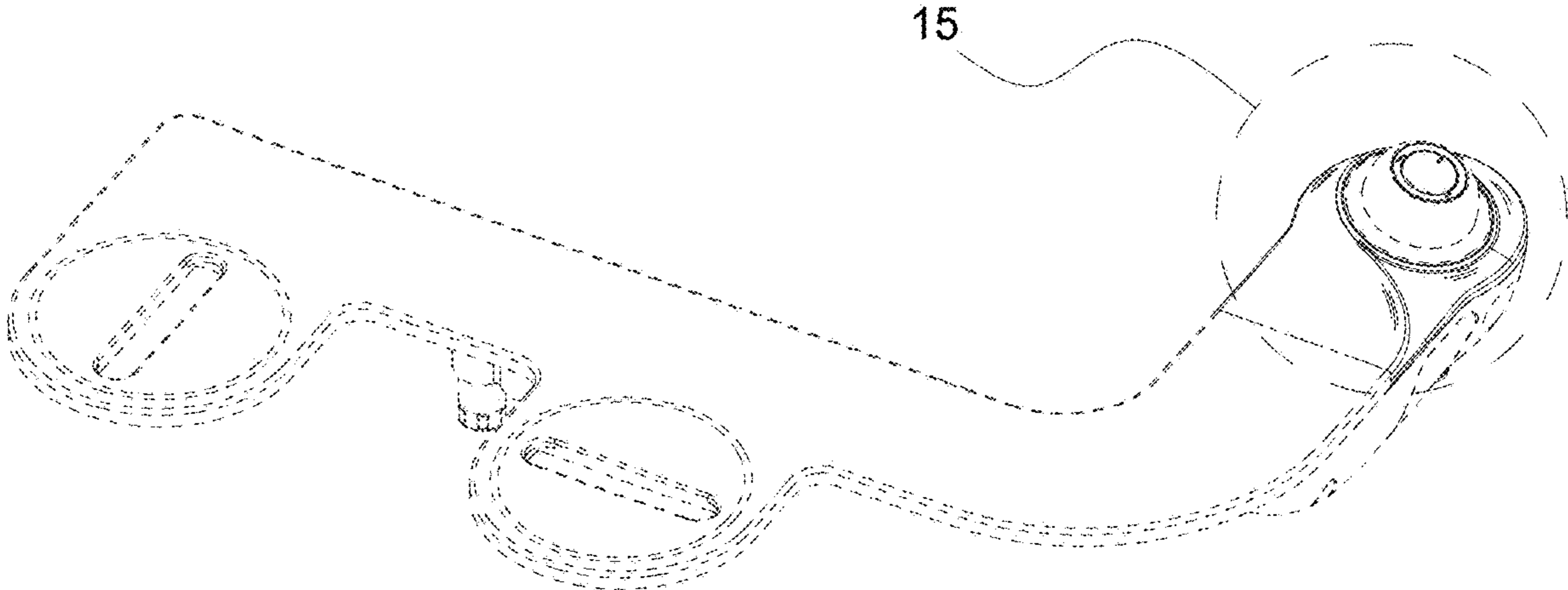

FIG.2

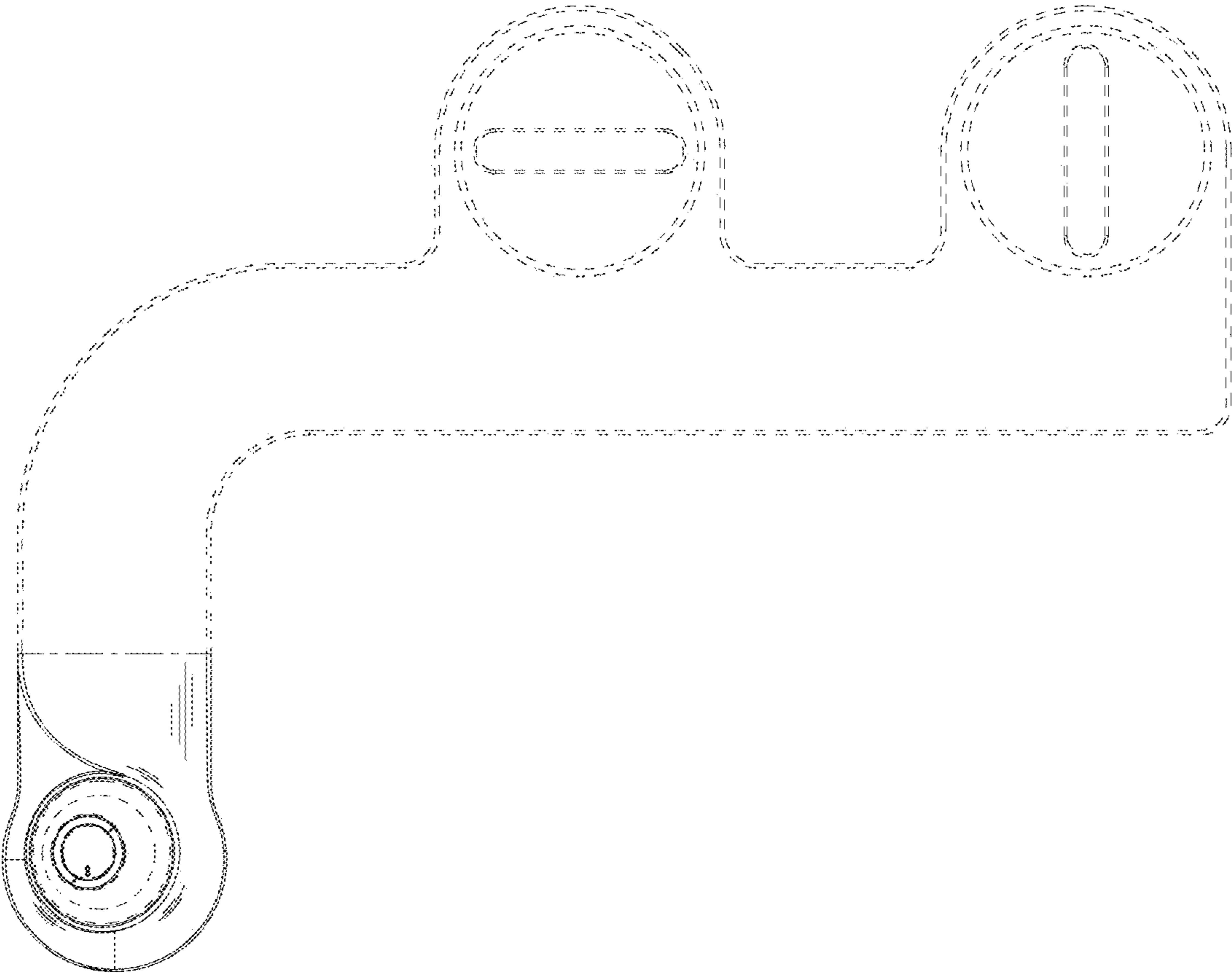

FIG.3

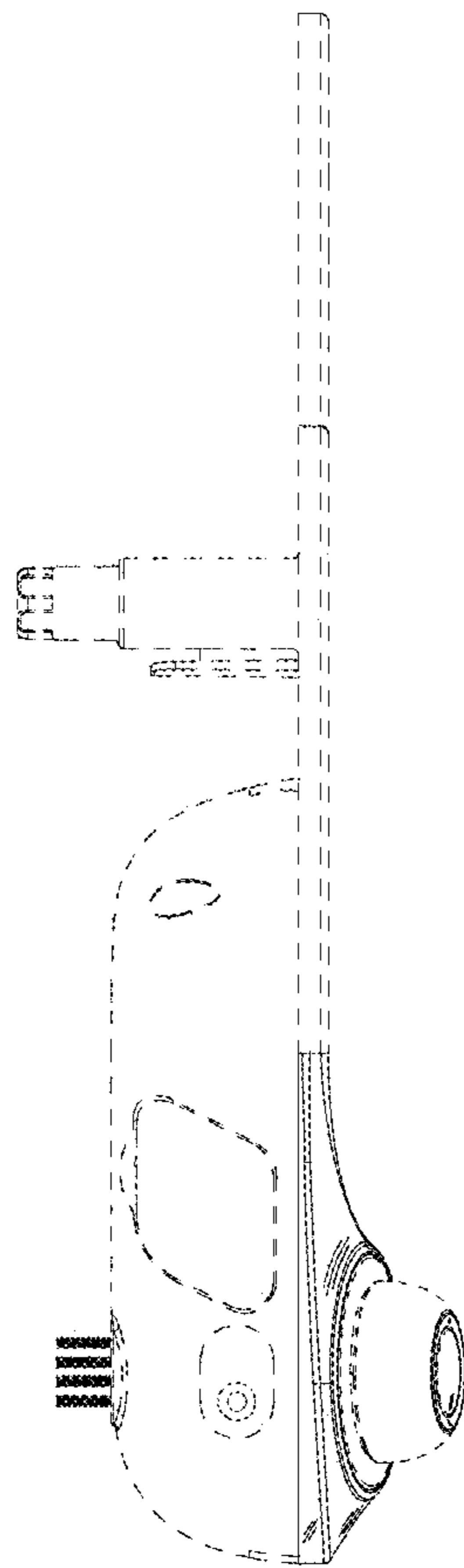

FIG.4

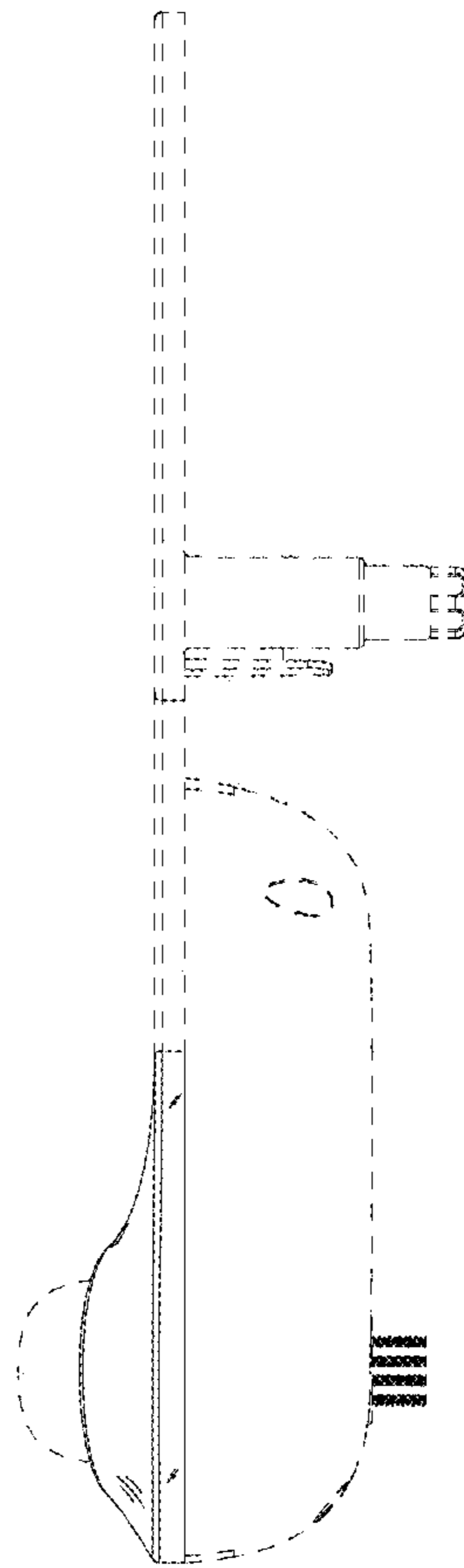

FIG.5

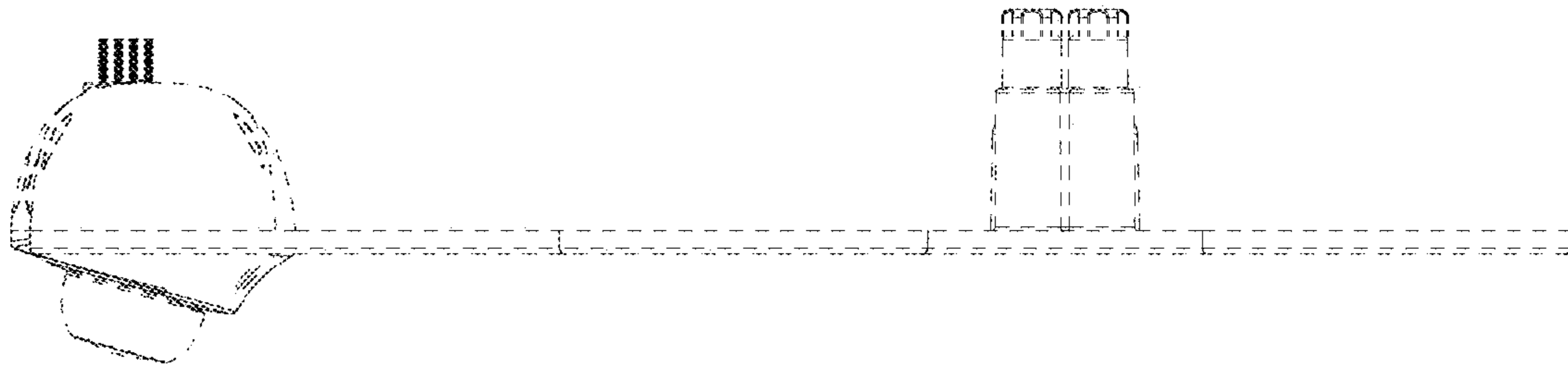

FIG.6

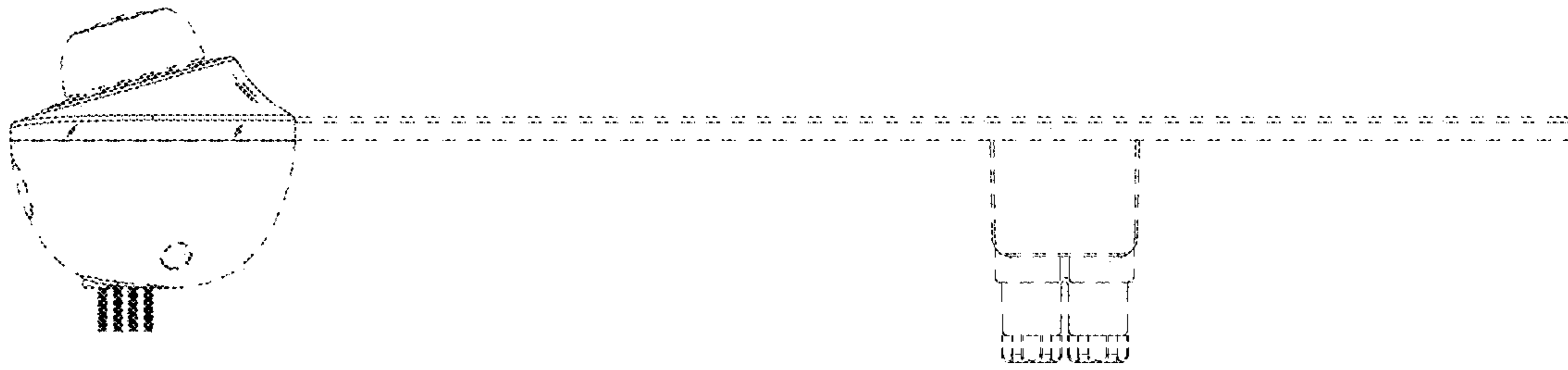

FIG.7



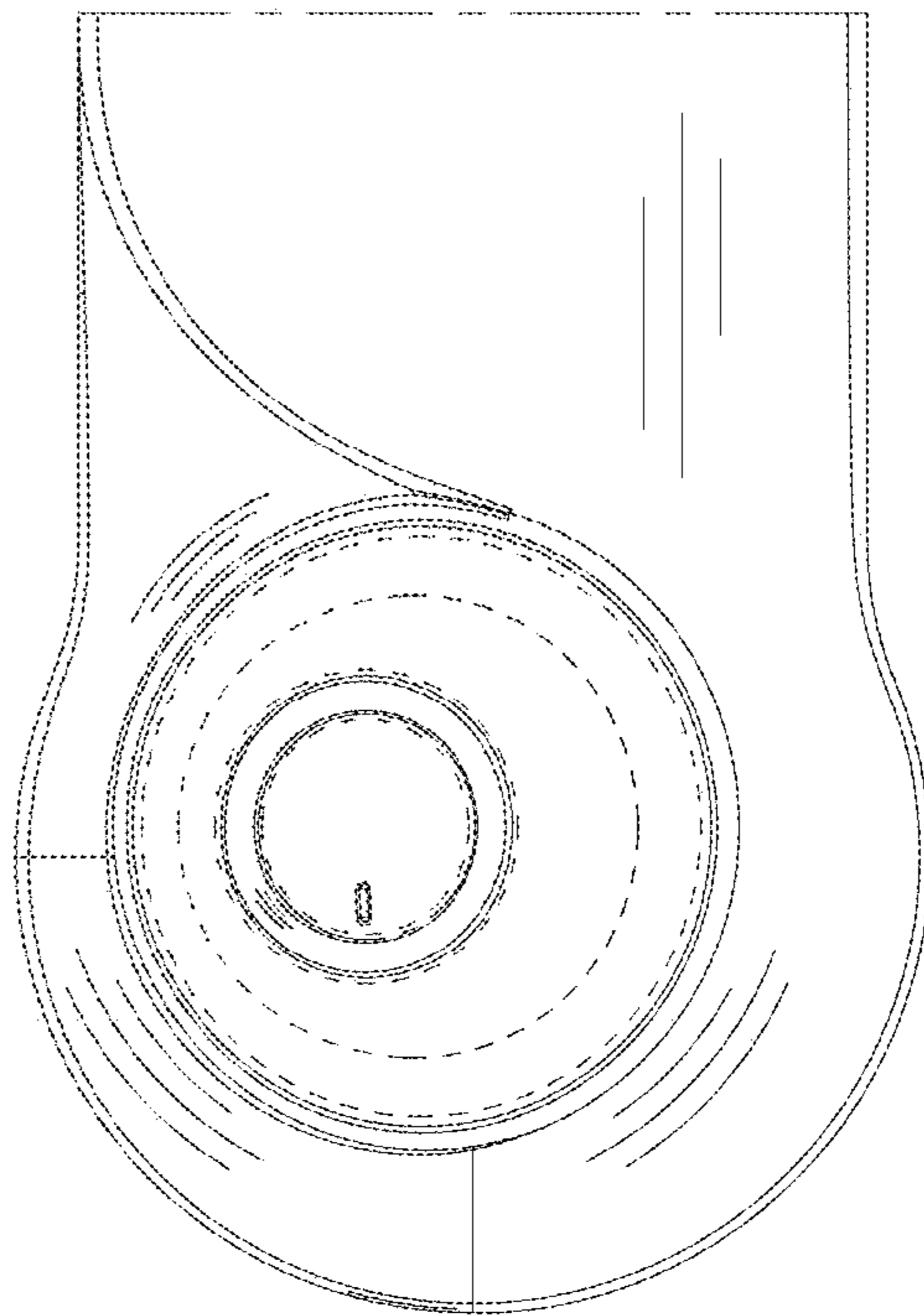

FIG.8

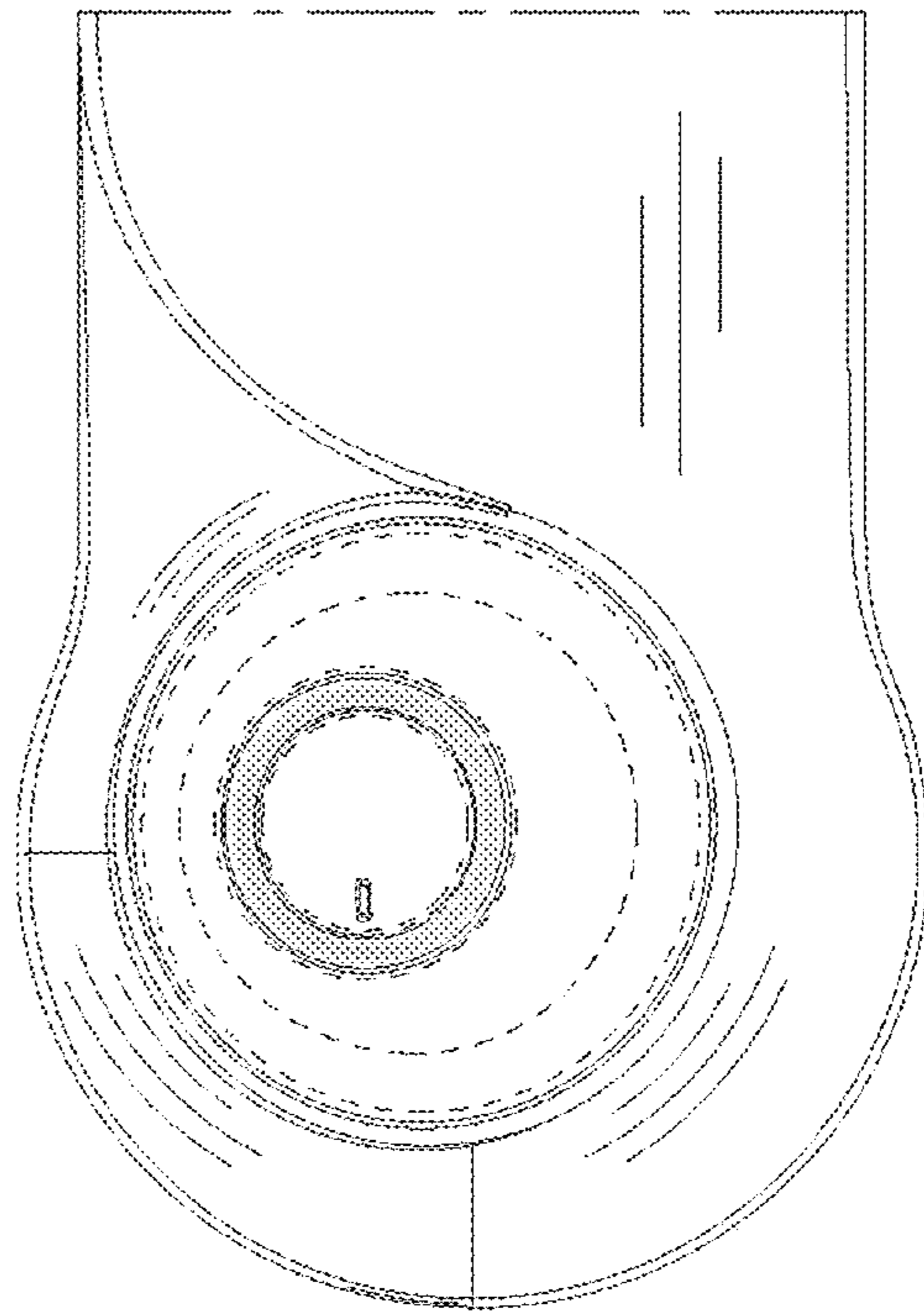

FIG.9

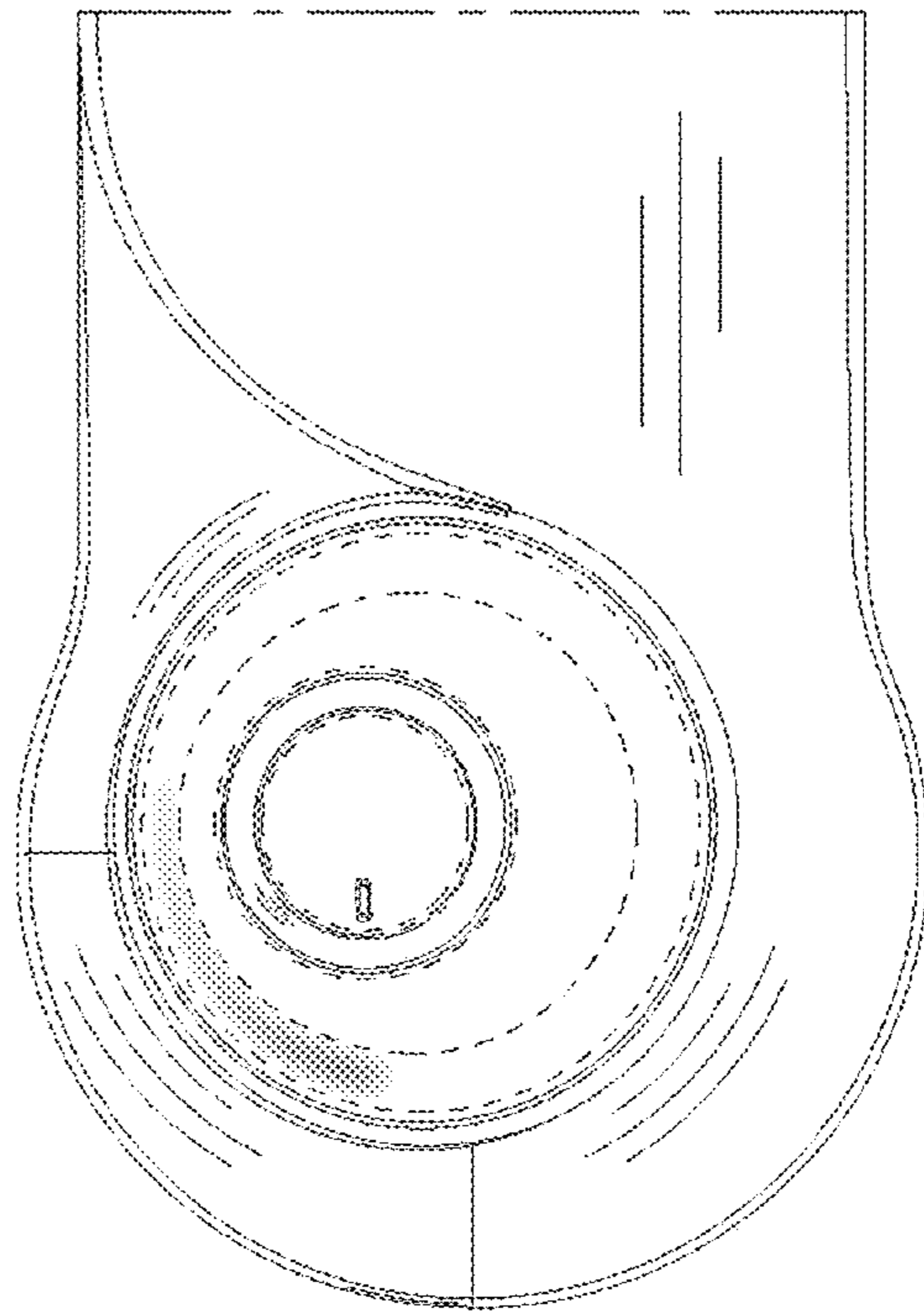

FIG.10

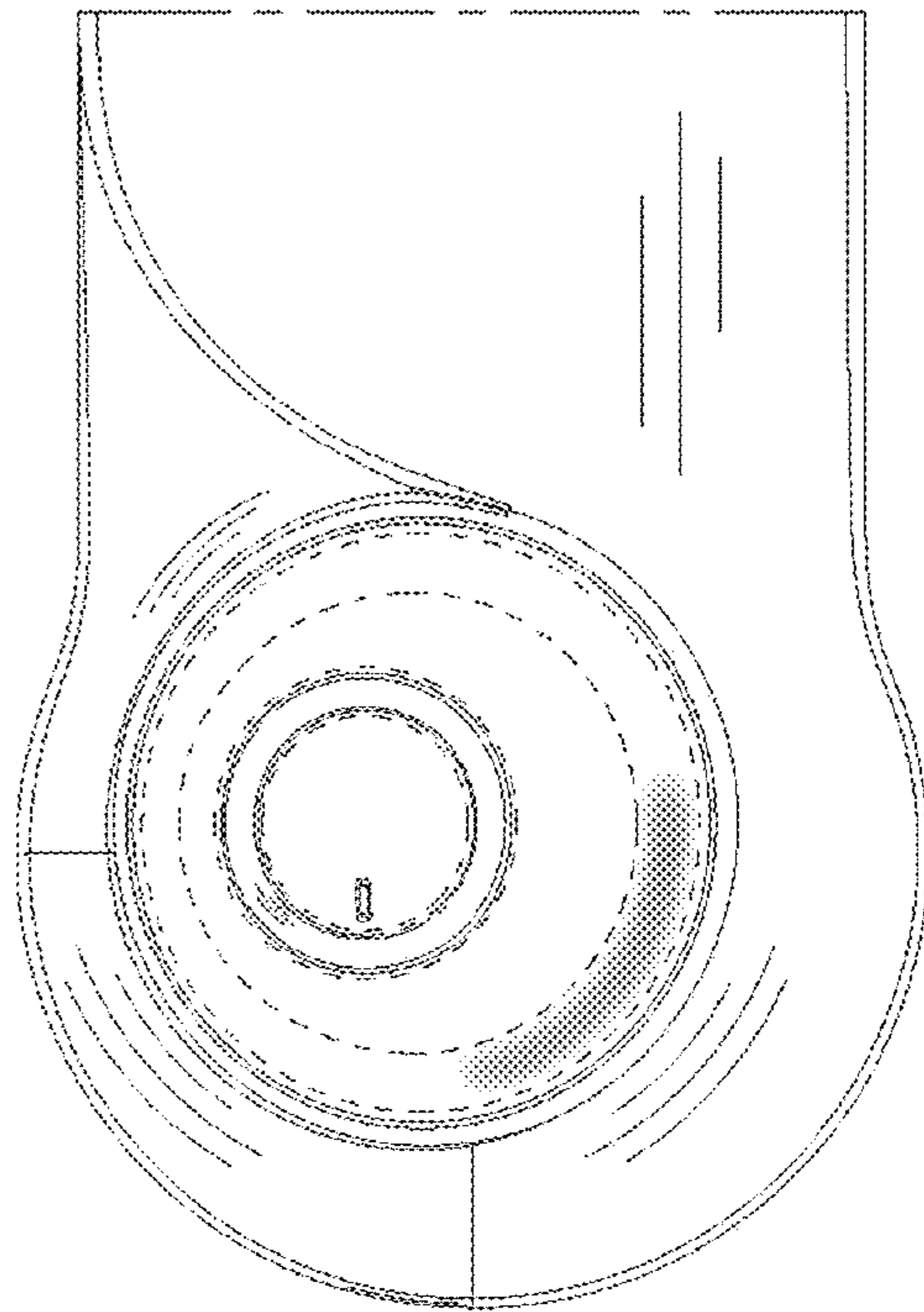

FIG.11

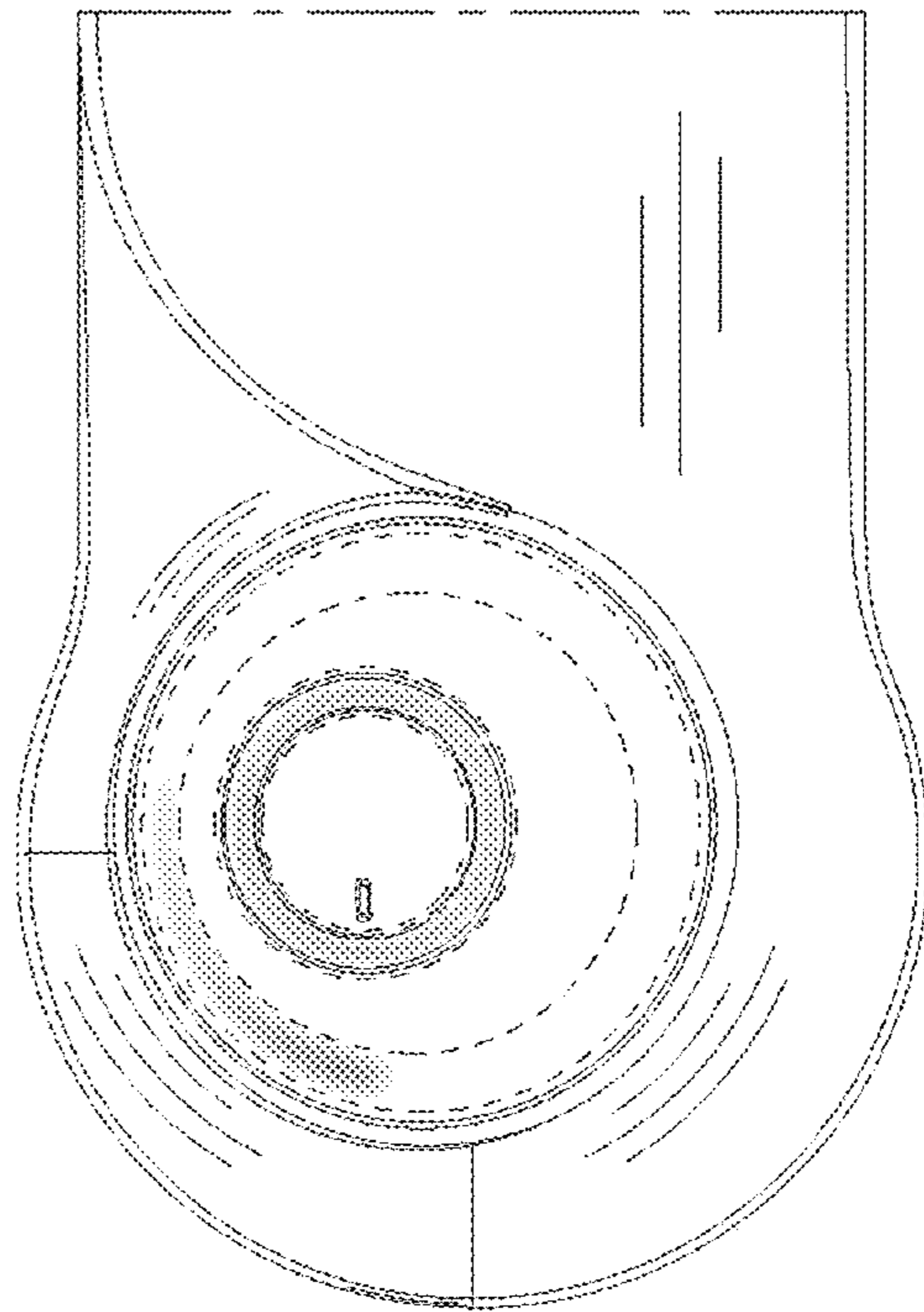

FIG.12

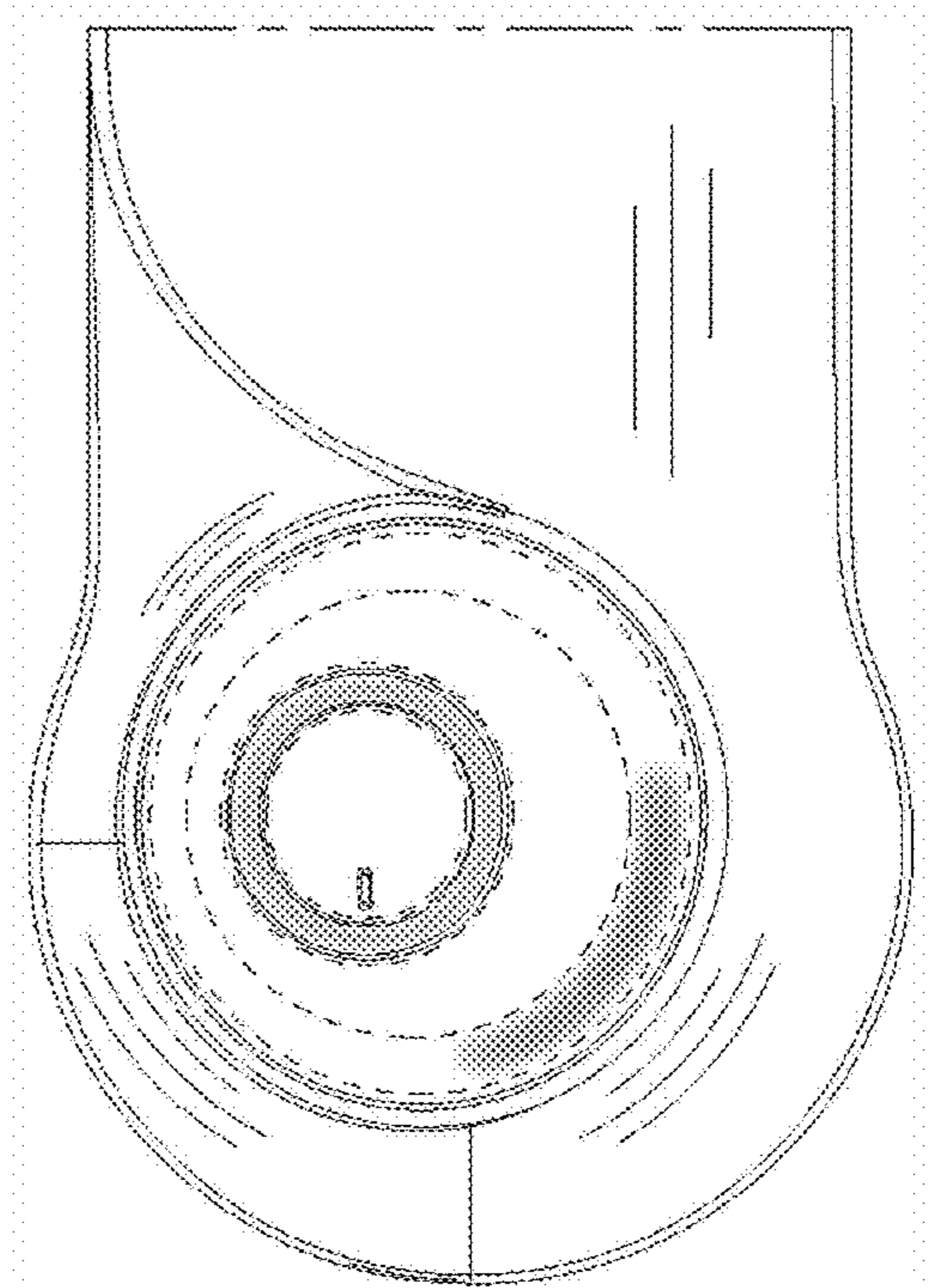

FIG.13

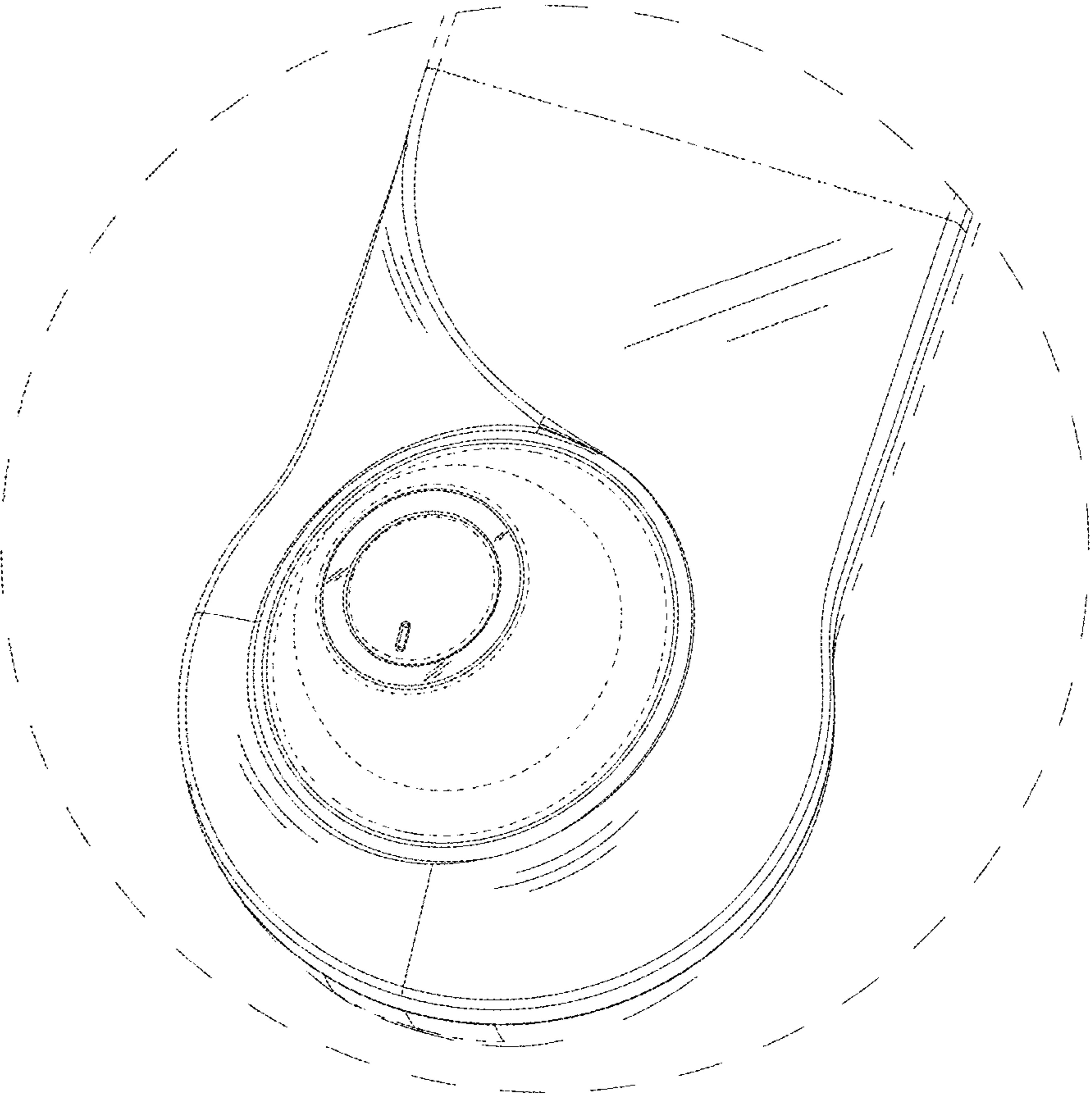

FIG.14

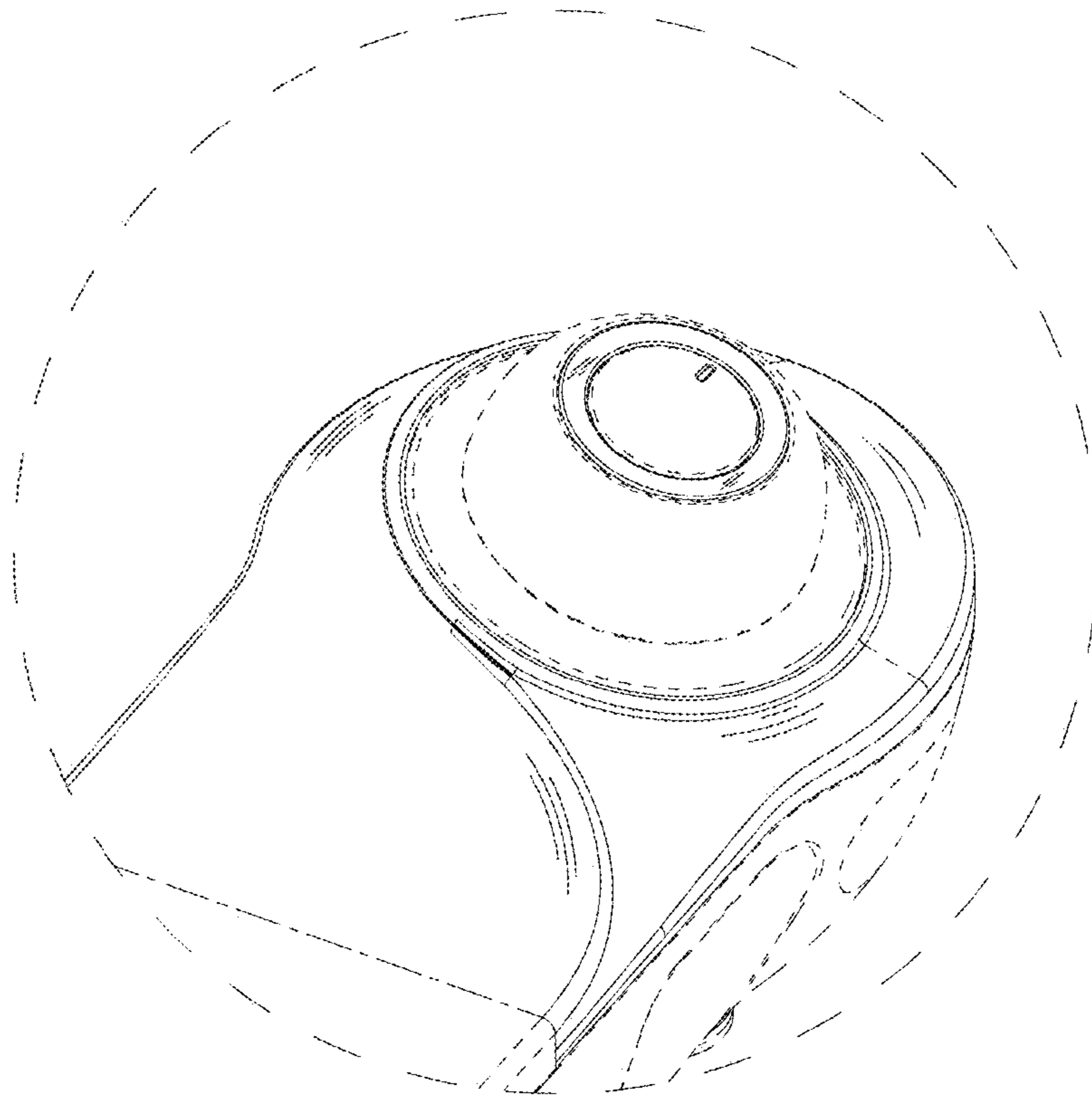

FIG.15