



US00D875882S

(12) **United States Design Patent** (10) **Patent No.:** **US D875,882 S**
Harmon (45) **Date of Patent:** **** Feb. 18, 2020**

(54) **DISCHARGE VALVE ASSEMBLY**
(71) Applicant: **Jetech, Inc.**, Battle Creek, MI (US)
(72) Inventor: **Jacob Harmon**, Wayland, MI (US)
(73) Assignee: **Jetech, Inc.**, Battle Creek, MI (US)
(**) Term: **15 Years**

D715,401 S * 10/2014 Spraw D23/213
D726,282 S * 4/2015 Ivy D23/213
8,998,593 B2 4/2015 Vicars
9,188,122 B1 11/2015 Reed
D745,638 S * 12/2015 Hickman D23/233
9,249,798 B2 2/2016 Ganguly et al.
9,382,905 B2 7/2016 Huang
D765,222 S * 8/2016 Norris, Jr. D23/213
9,670,922 B2 6/2017 Pacht
D838,350 S * 1/2019 Downs F16L 37/0841
D23/262
2011/0189040 A1 8/2011 Vicars

(21) Appl. No.: **29/635,741**

(22) Filed: **Feb. 2, 2018**

(51) **LOC (12) Cl.** **23-01**

(52) **U.S. Cl.**
USPC **D23/213**

(58) **Field of Classification Search**
USPC D23/233, 235, 237, 241, 247, 248, 249,
D23/262, 213; 251/148; 137/223, 438,
137/614.03, 624.27, 874, 454.4, 512,
137/543.23; 417/559, 437, 571, 454, 567
CPC F16L 41/04; F16L 47/345; F16L 41/18;
F16L 25/14; F16K 27/067
See application file for complete search history.

(56) **References Cited**

U.S. PATENT DOCUMENTS

5,605,449 A 2/1997 Reed
D435,635 S * 12/2000 Taneya D23/233
D463,537 S * 9/2002 Koza D23/233
D499,464 S * 12/2004 Caine D23/233
D567,900 S * 4/2008 Patterson D23/213
D620,084 S * 7/2010 Talamantez D23/262
D623,264 S * 9/2010 Parrott D23/213

* cited by examiner

Primary Examiner — Gino Colan

(74) *Attorney, Agent, or Firm* — Warner Norcross + Judd, LLP

(57) **CLAIM**

The ornamental design for a discharge valve assembly, as shown and described.

DESCRIPTION

FIG. 1 is a top perspective view of a discharge valve assembly showing my new design; FIG. 2 is a right side elevation view thereof; FIG. 3 is a front elevation view thereof, the rear elevation view being a mirror image thereof; FIG. 4 is a left side elevation view thereof; FIG. 5 is a top plan view thereof; and, FIG. 6 is a bottom plan view thereof. The broken lines shown in the figures are included for the purpose of illustrating environment and form no part of the claimed design.

1 Claim, 3 Drawing Sheets

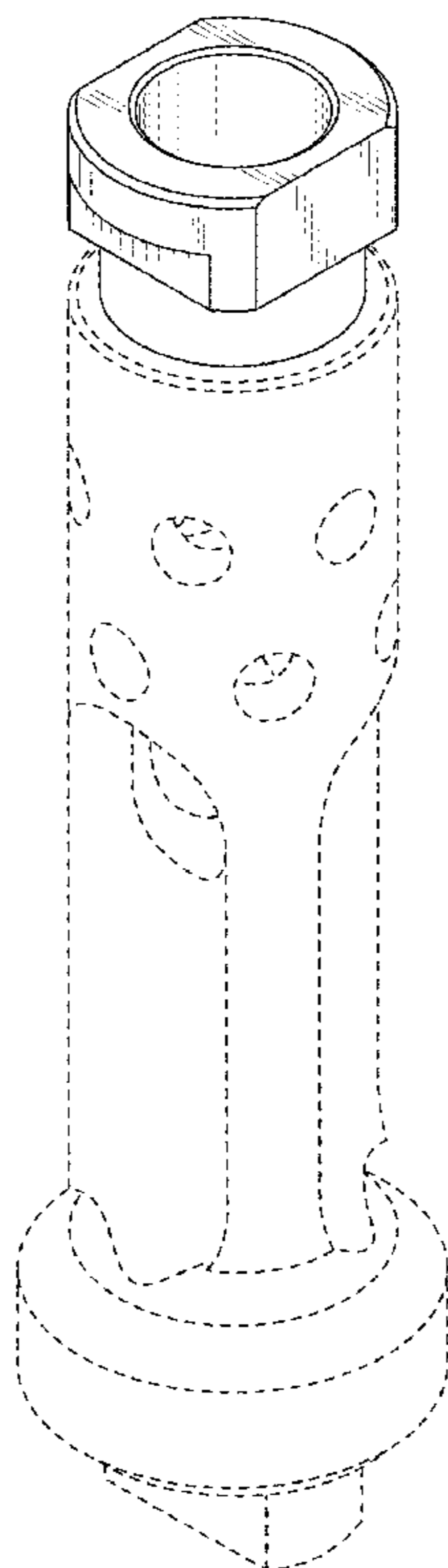

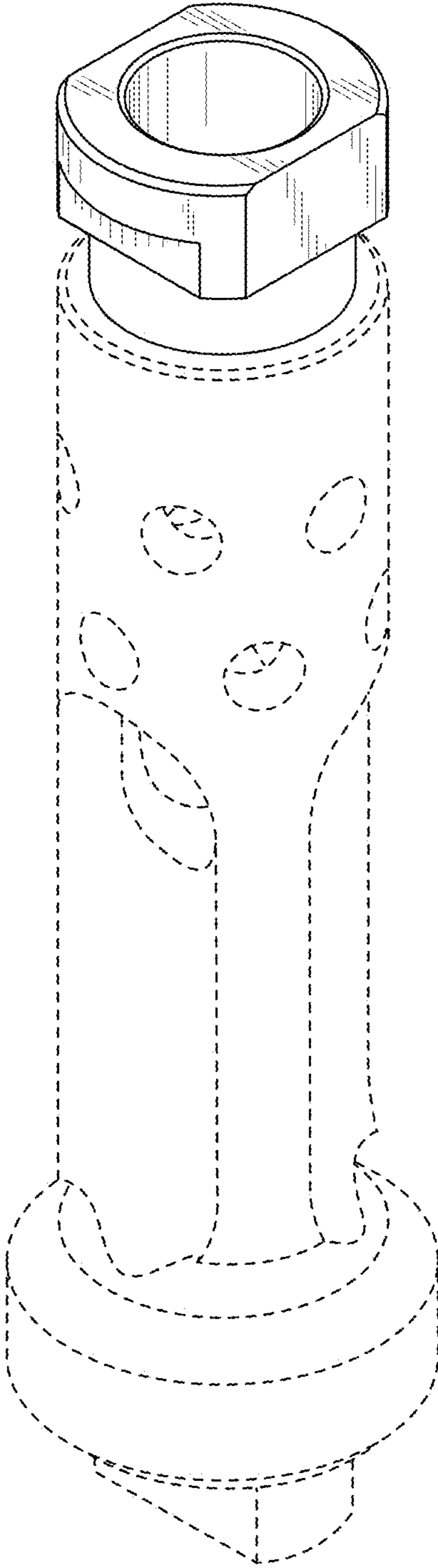

Fig. 1

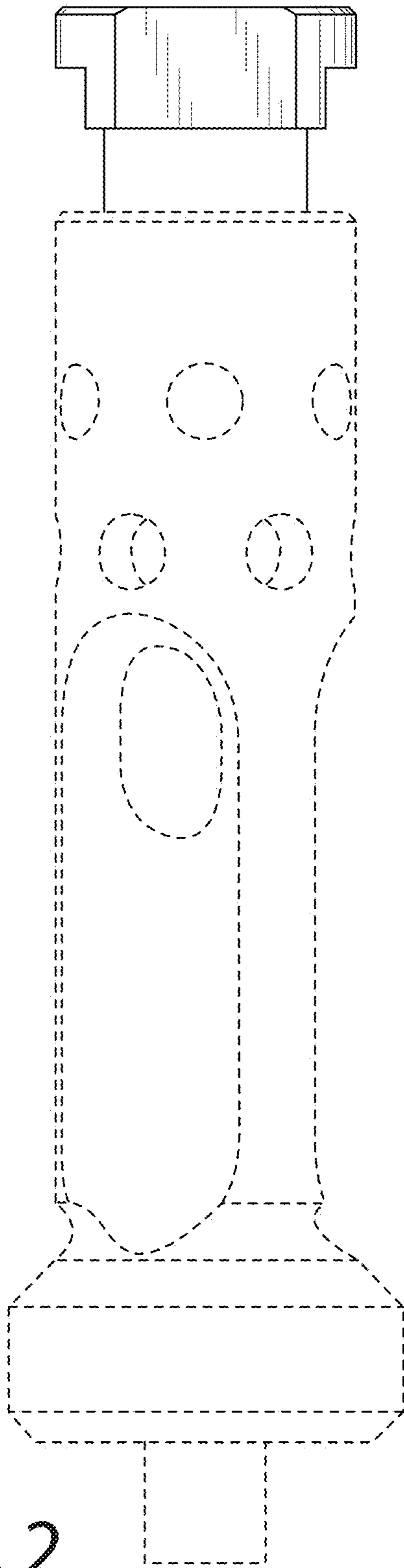

Fig. 2

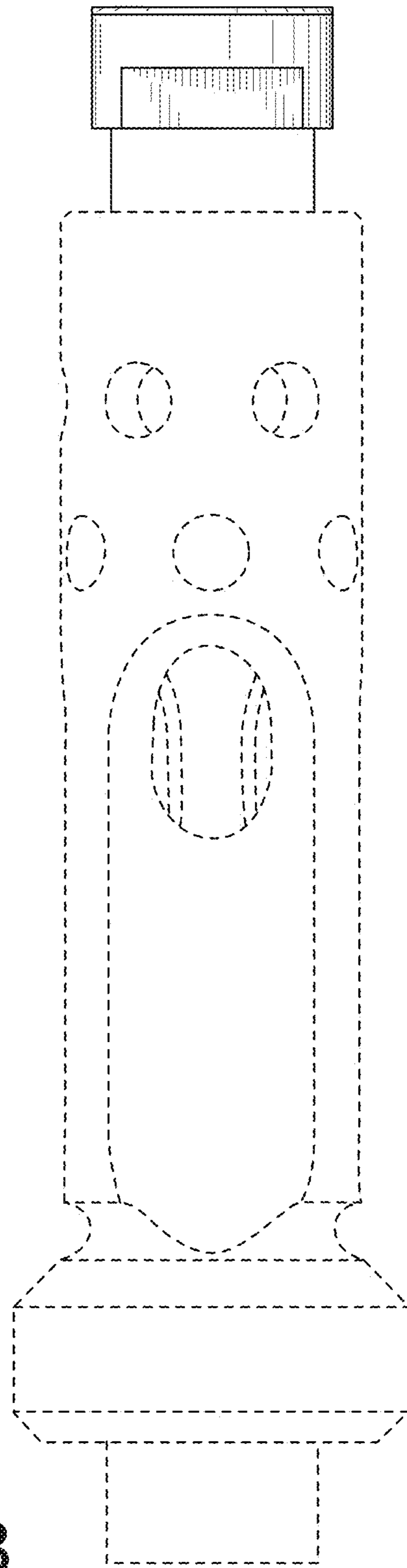

Fig. 3

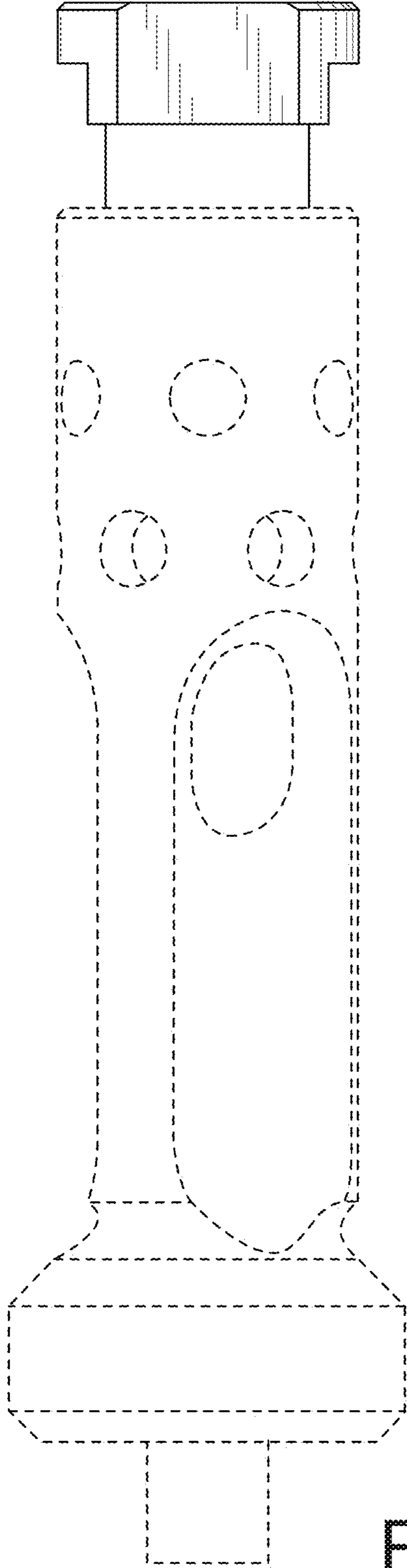

Fig. 4

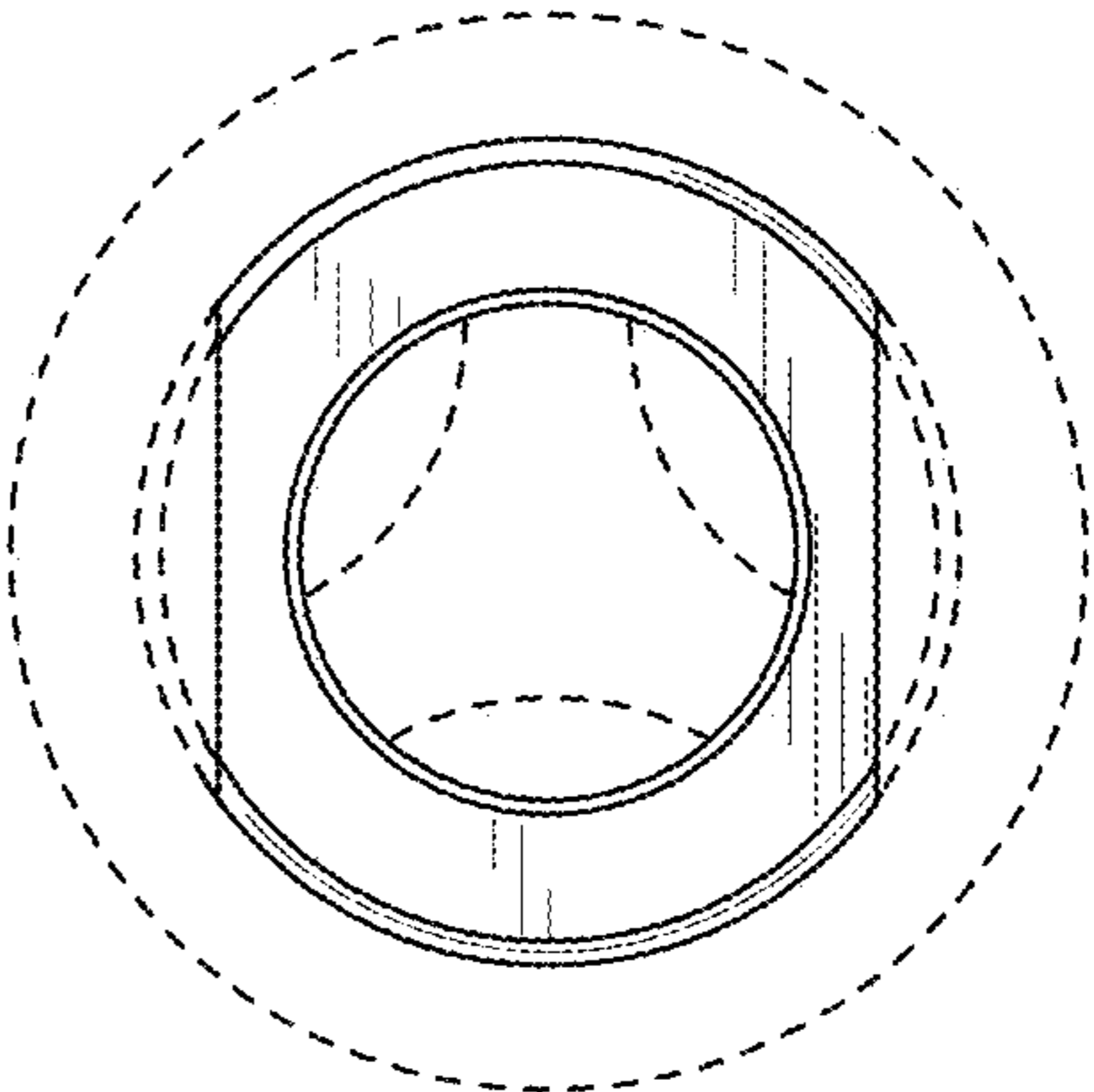

Fig. 5

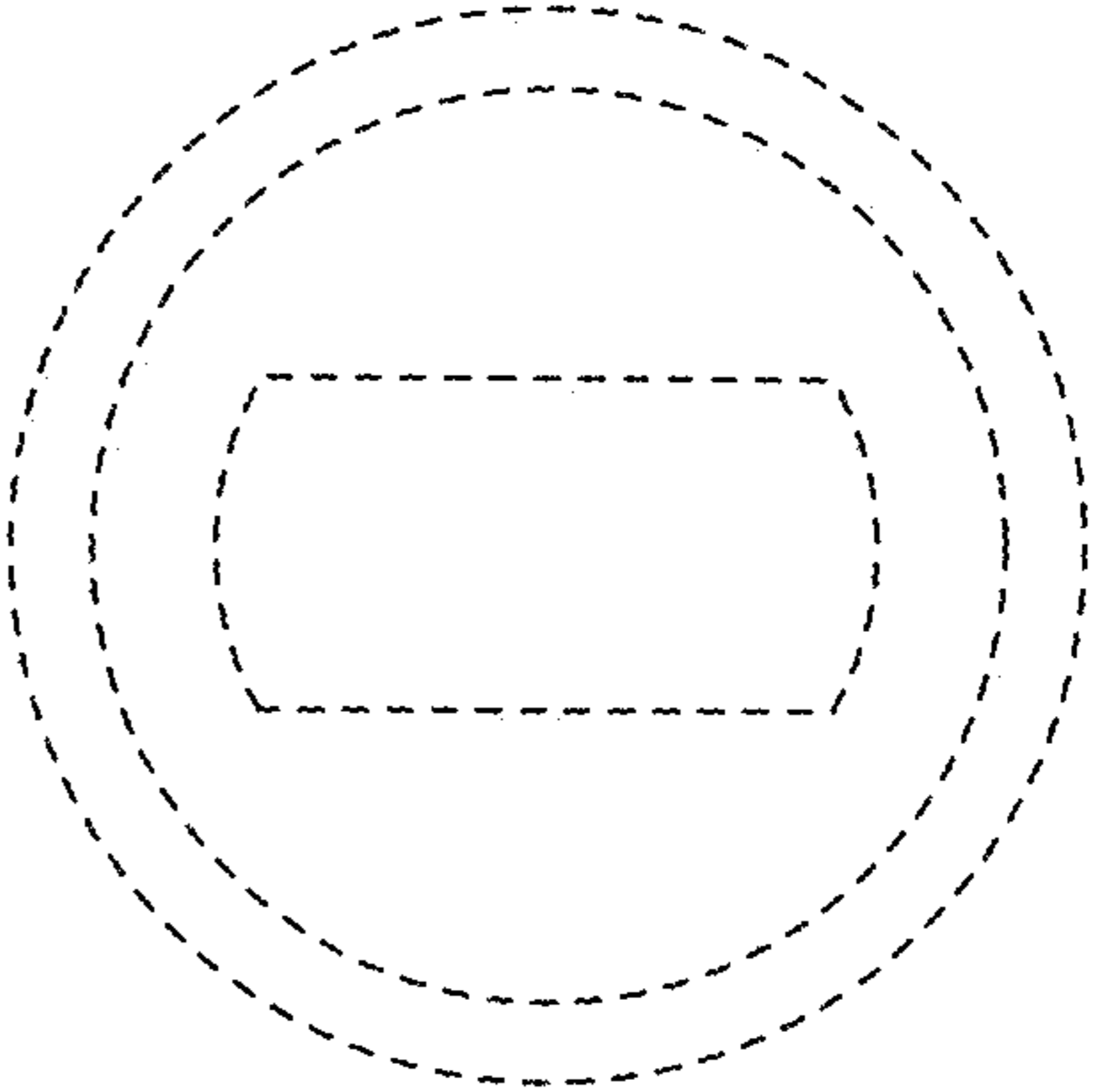

Fig. 6