



US00D875792S

(12) **United States Design Patent** (10) **Patent No.:** **US D875,792 S**
Huang et al. (45) **Date of Patent:** **** Feb. 18, 2020**

(54) **REFRIGERATOR**

(56) **References Cited**

(71) Applicants: **HEFEI MIDEA REFRIGERATOR CO., LTD.**, Anhui (CN); **HEFEI HUALING CO., LTD.**, Anhui (CN); **MIDEA GROUP CO., LTD.**, Guangdong (CN)

U.S. PATENT DOCUMENTS

D639,315 S	*	6/2011	Yang	D15/85
D655,321 S	*	3/2012	Lee	D15/86
D668,696 S	*	10/2012	Seo	D15/86
D685,010 S	*	6/2013	Seo	D15/86
D707,735 S	*	6/2014	Cho	D15/91
D709,105 S	*	7/2014	Saejin	D15/85
D710,402 S	*	8/2014	Jeon	D15/86
D718,346 S	*	11/2014	Cho	D15/81
D759,733 S	*	6/2016	Lee	D15/85

(72) Inventors: **Wei Huang**, Anhui (CN); **Ankai Liao**, Anhui (CN); **Feng Wen**, Anhui (CN)

* cited by examiner

(73) Assignees: **HEFEI MIDEA REFRIGERATOR CO., LTD.**, Hefei (CN); **HEFEI HUALING CO., LTD.**, Hefei (CN); **MIDEA GROUP CO., LTD.**, Foshan (CN)

Primary Examiner — Khawaja Anwar
 (74) *Attorney, Agent, or Firm* — Morgan, Lewis & Bockius LLP

(**) Term: **15 Years**

(57) **CLAIM**

The ornamental design for a refrigerator, as shown and described.

(21) Appl. No.: **29/644,959**

DESCRIPTION

(22) Filed: **Apr. 23, 2018**

(51) **LOC (12) Cl.** **15-07**

(52) **U.S. Cl.**
USPC **D15/85**

(58) **Field of Classification Search**
 USPC D15/79–91
 CPC F25D 17/065; F25D 23/028; F25D 23/04;
 F25D 21/00; F25D 21/006; F25D 21/008;
 F25D 21/04; F25D 21/08; F25D 21/14;
 F25D 2317/061; F25D 2317/062; F25D
 23/065; F25D 23/067; F25D 2400/02;
 F25D 2500/06; F25D 2600/06; F25D
 2700/02; F25D 2700/14; F25D 29/00

FIG. 1 is a front perspective view of a refrigerator showing our new design;
 FIG. 2 is a front elevational view of the refrigerator showing our new design;
 FIG. 3 is a rear elevational view of the refrigerator shown in FIG. 1;
 FIG. 4 is a left-side elevational view of the refrigerator shown in FIG. 1;
 FIG. 5 is a right-side elevational view of the refrigerator shown in FIG. 1;
 FIG. 6 is a top plan view of the refrigerator shown in FIG. 1; and,
 FIG. 7 is a bottom plan view of the refrigerator shown in FIG. 1.

See application file for complete search history.

1 Claim, 5 Drawing Sheets

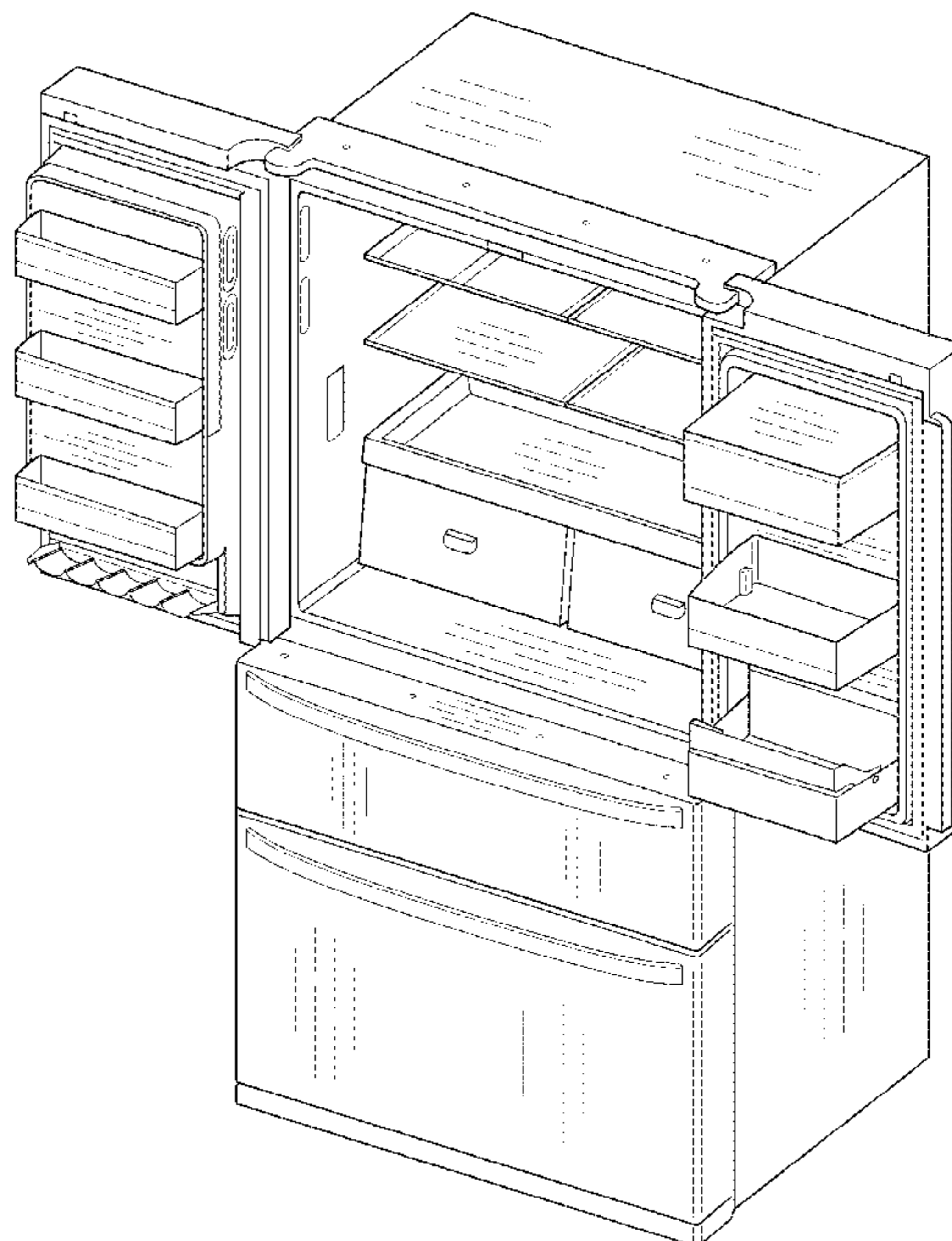

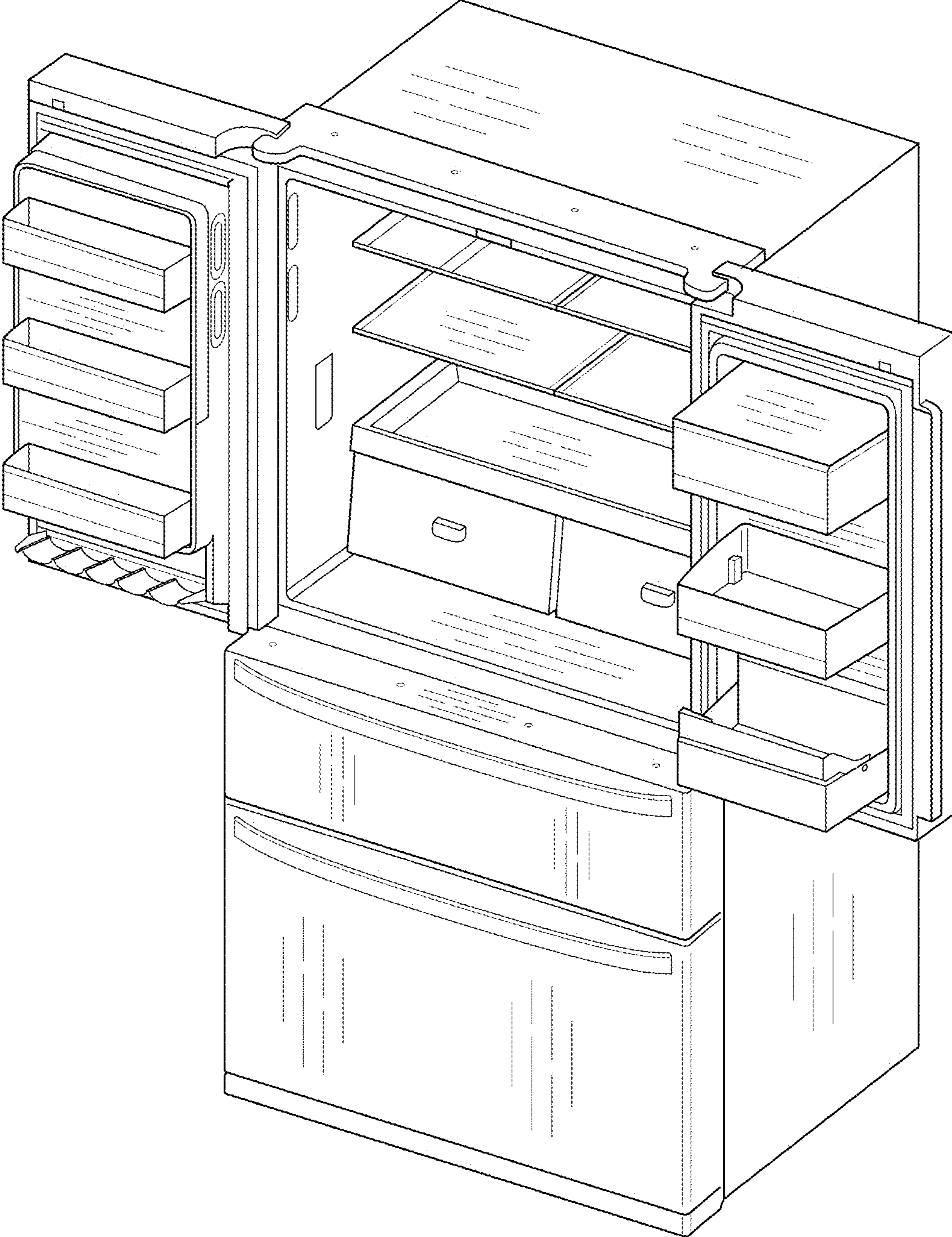

FIG. 1

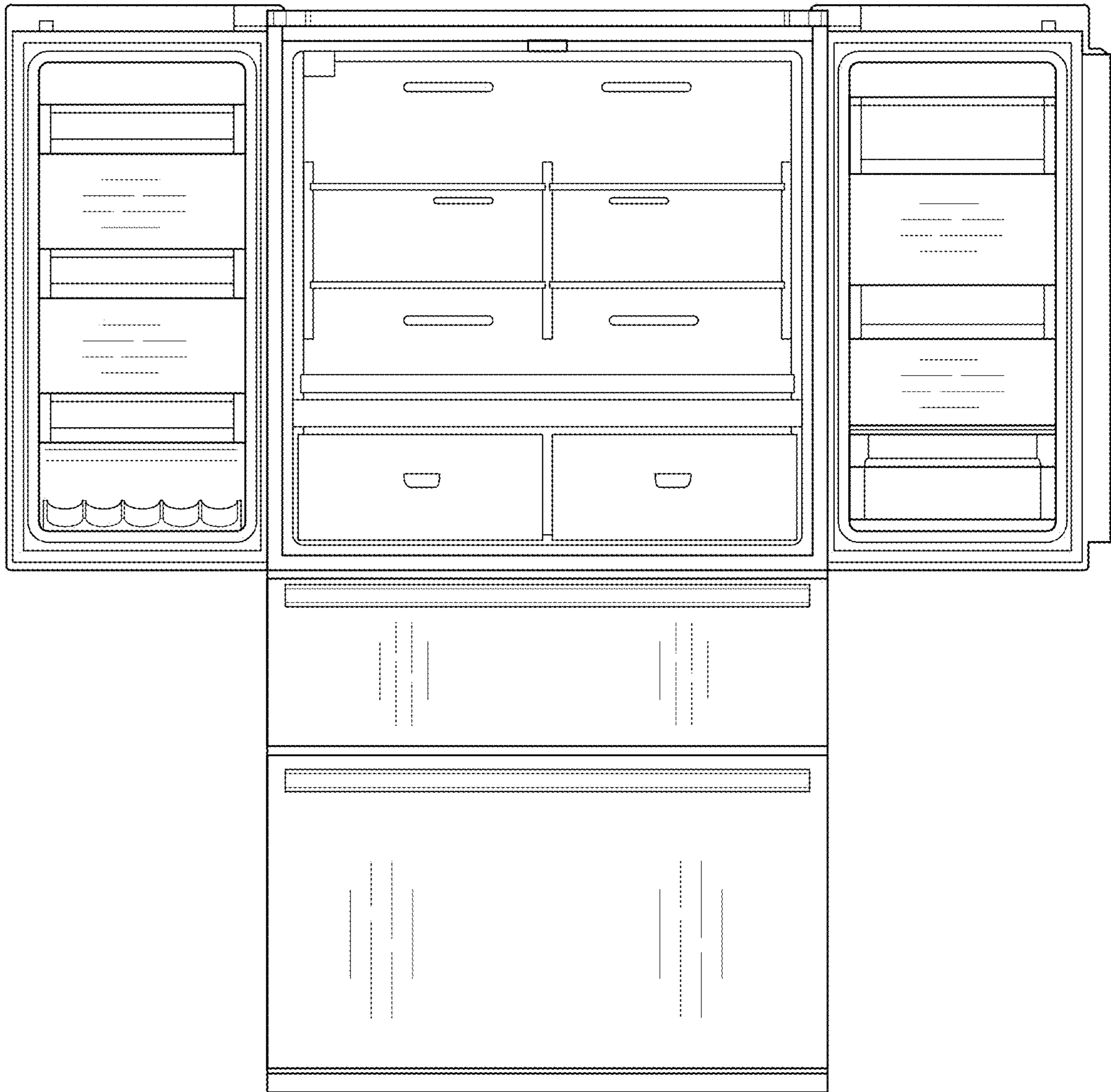

FIG. 2

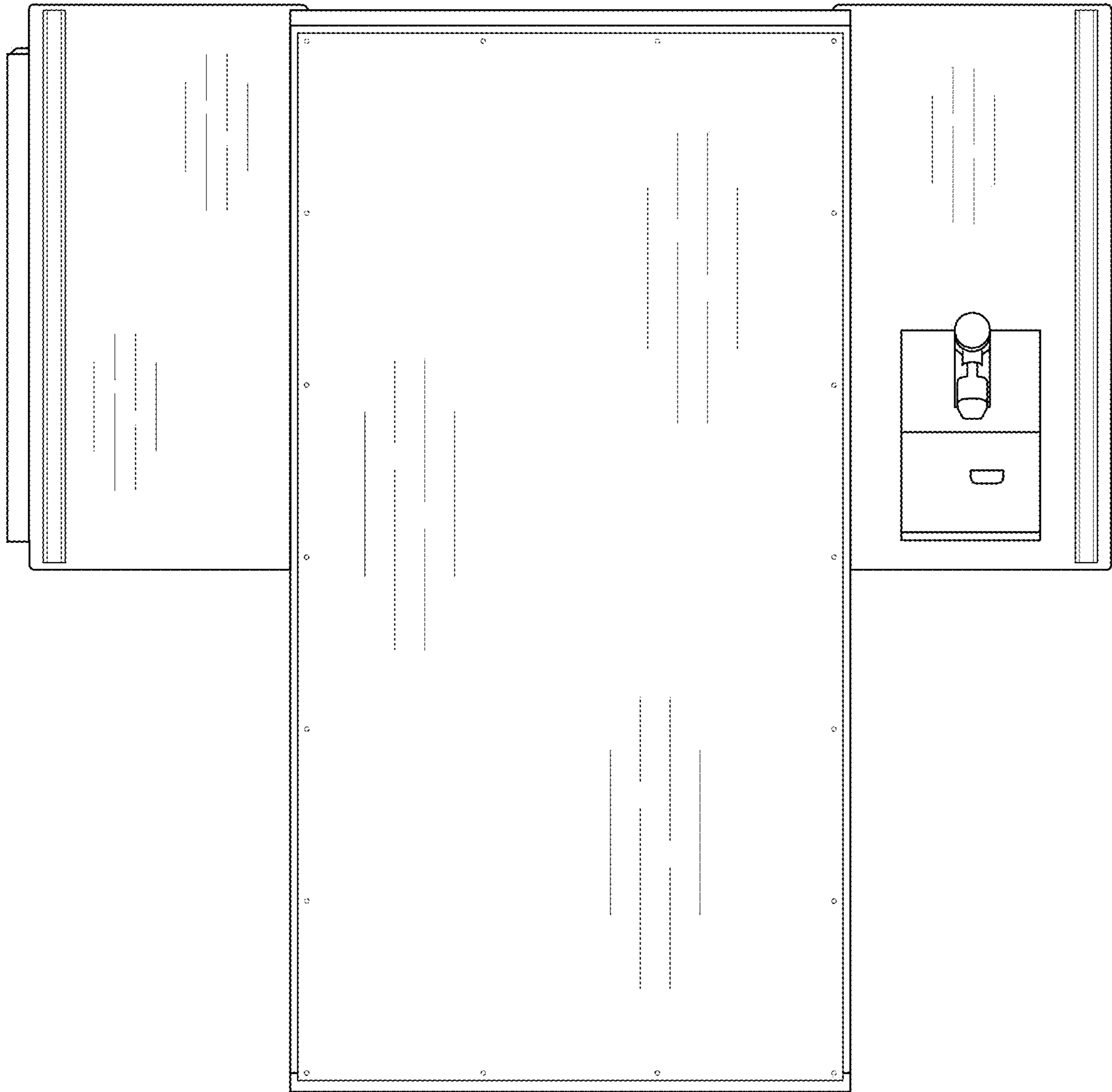

FIG. 3

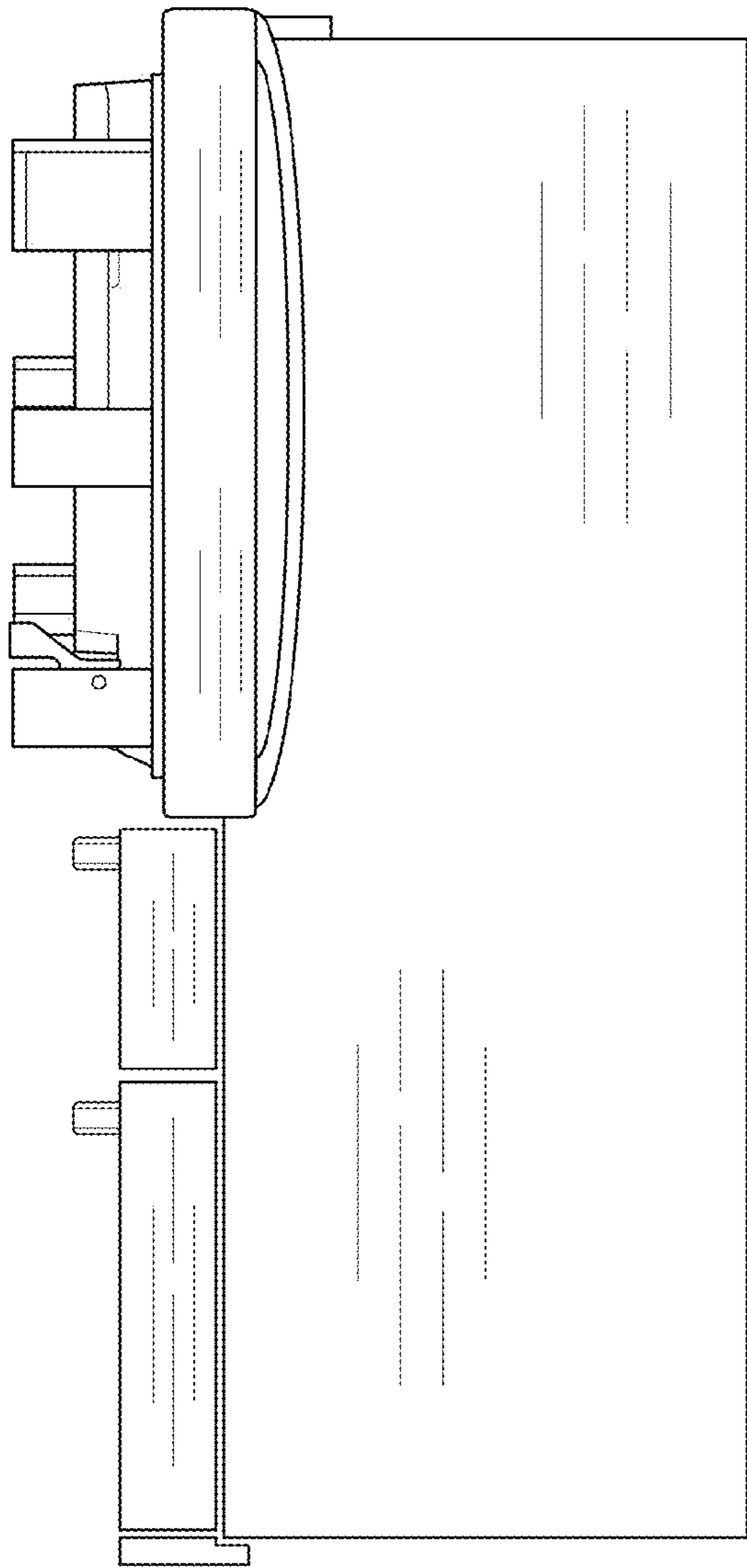

FIG. 4

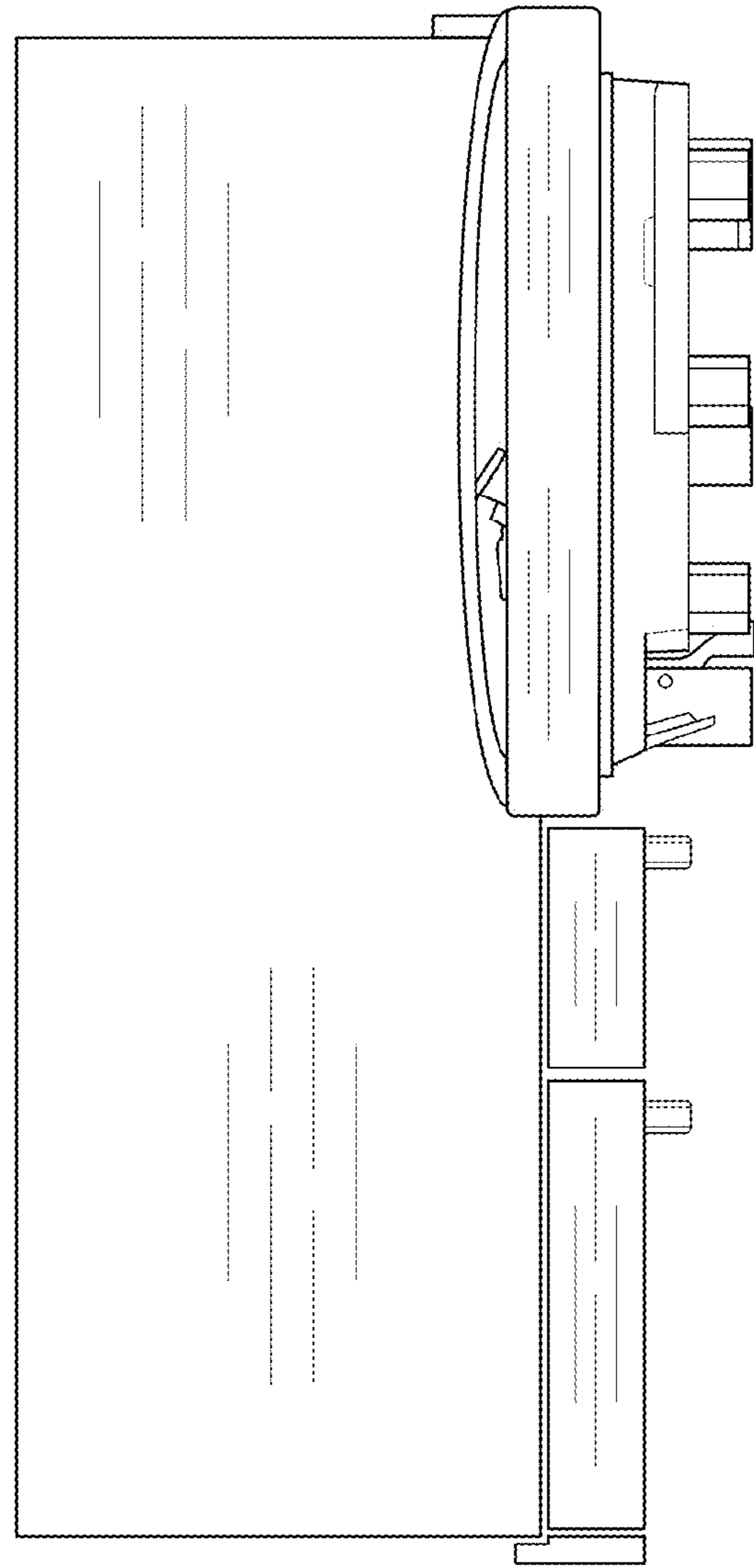

FIG. 5

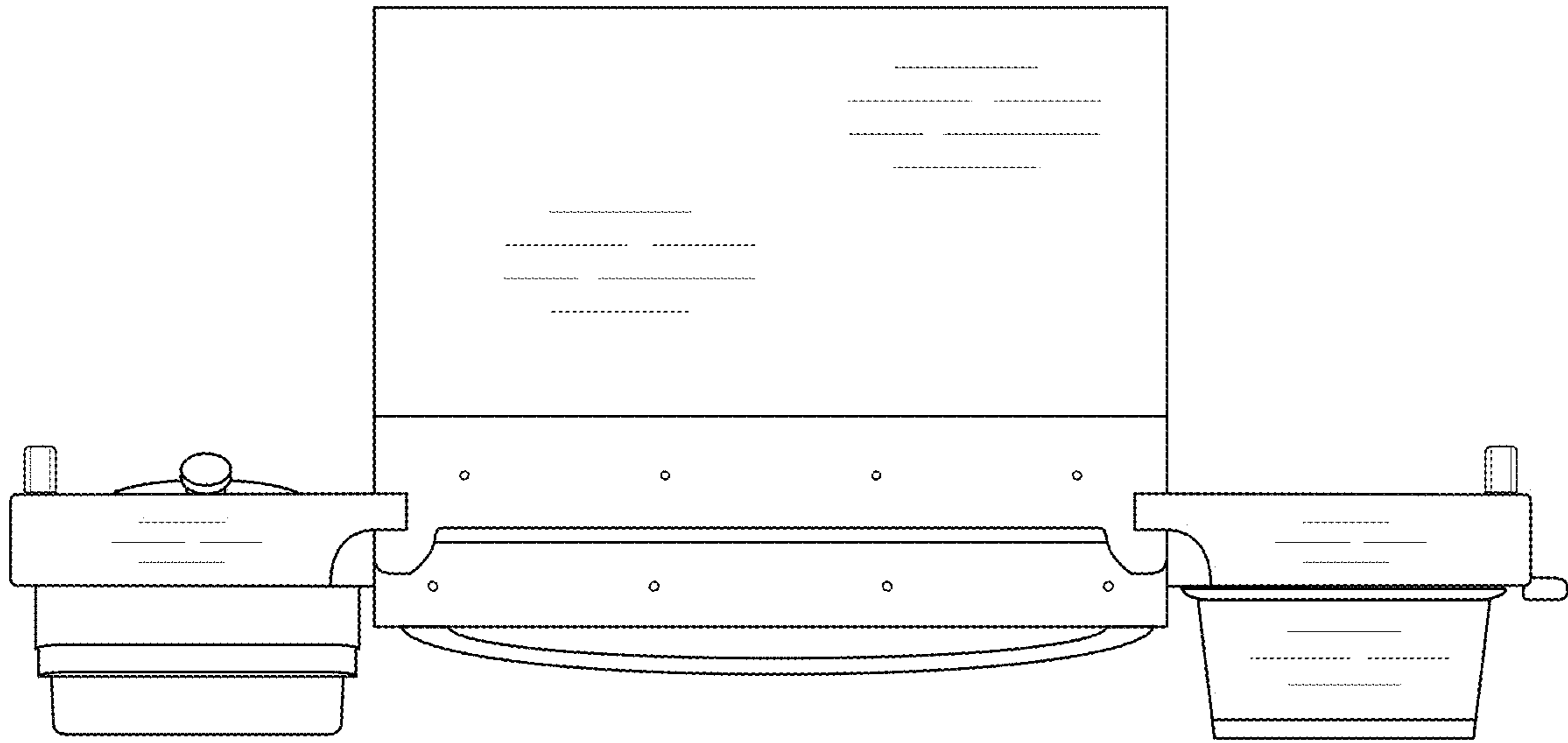

FIG. 6

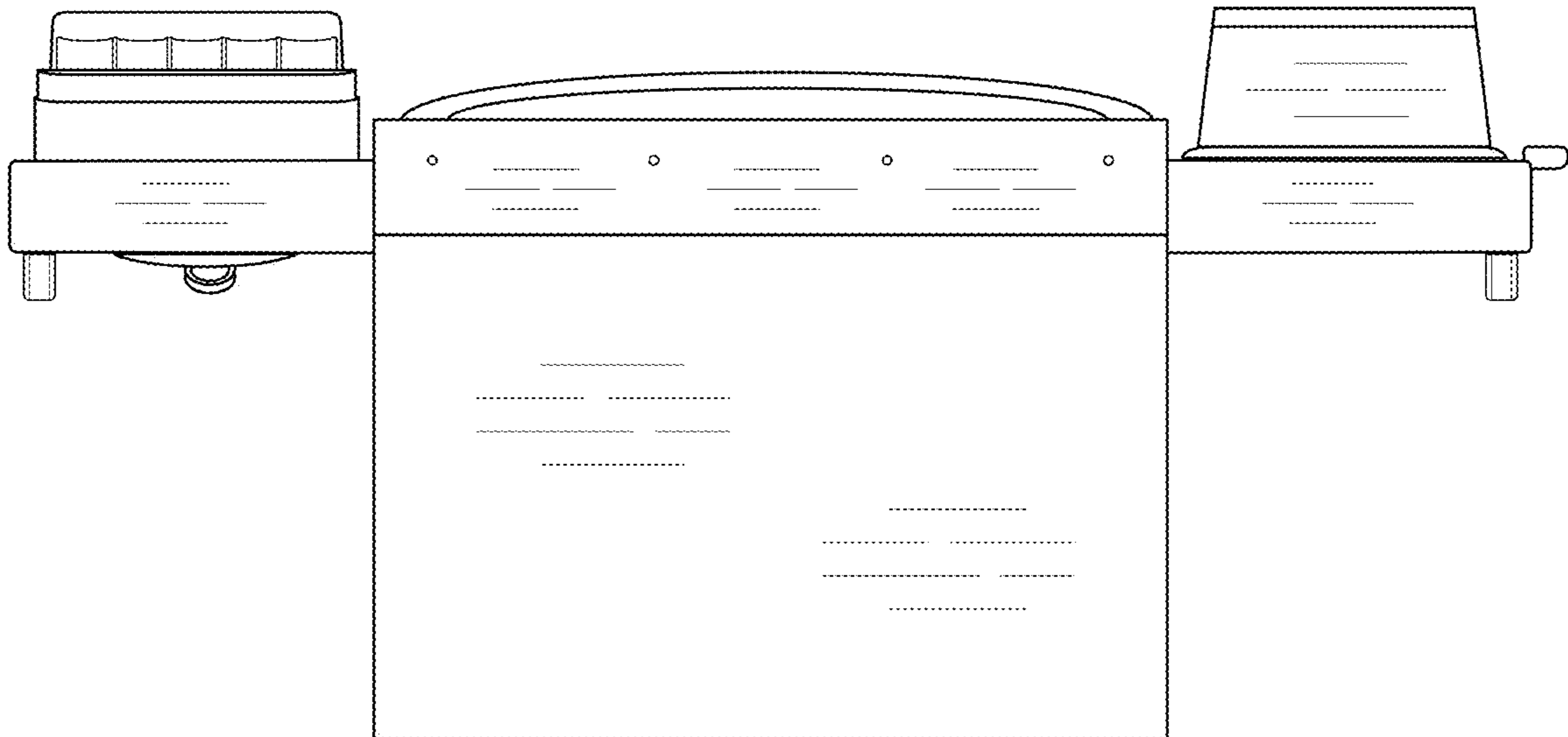

FIG. 7