



US00D875730S

(12) **United States Design Patent**  
**Lau et al.**

(10) **Patent No.:** **US D875,730 S**

(45) **Date of Patent:** **\*\* Feb. 18, 2020**

(54) **HEAD-MOUNTED DISPLAY DEVICE**

(71) Applicant: **VOTANIC Ltd.**, Hong Kong (CN)

(72) Inventors: **Ying Kei Henry Lau**, Hong Kong (CN); **Kin Yip Chan**, Hong Kong (CN); **Wai Lam Tam**, Hong Kong (CN); **Ka Tsun Adrian Ng**, Hong Kong (CN); **Hing Tobey Ko**, Hong Kong (CN)

(73) Assignee: **VOTANIC LTD.**, Hong Kong (CN)

(\*\*) Term: **15 Years**

(21) Appl. No.: **29/662,436**

(22) Filed: **Sep. 5, 2018**

(51) **LOC (12) Cl.** ..... **14-02**

(52) **U.S. Cl.**  
USPC ..... **D14/372**

(58) **Field of Classification Search**  
USPC ..... D14/372, 496, 432, 371, 125, 126, 129, D14/299; D16/300-342; 351/158, 153, 351/144; 345/7-9, 905; 455/344; 348/115, 53, 121, 739  
CPC ..... G02B 27/017; G02B 27/0158; G02B 27/0161; G02B 27/0181; G02B 27/0185; G02B 27/0189

See application file for complete search history.

(56) **References Cited**

**U.S. PATENT DOCUMENTS**

D785,619 S \* 5/2017 Su ..... D14/372  
D795,867 S \* 8/2017 Huang ..... D14/372

D796,505 S \* 9/2017 Natsume ..... D14/372  
D796,506 S \* 9/2017 Natsume ..... D14/372  
D807,358 S \* 1/2018 Huang ..... D14/372  
D809,516 S \* 2/2018 Tabata ..... D14/372  
D812,612 S \* 3/2018 Gribetz ..... D14/372  
D815,092 S \* 4/2018 Liao ..... D14/372  
D839,269 S \* 1/2019 Wang ..... D14/372  
D844,605 S \* 4/2019 Yeh ..... D14/372  
D862,464 S \* 10/2019 Natsume ..... D14/372  
D862,468 S \* 10/2019 Chen ..... D14/372

\* cited by examiner

*Primary Examiner* — Austin Murphy

(74) *Attorney, Agent, or Firm* — Leason Ellis LLP

(57) **CLAIM**

The ornamental design for a head-mounted display device, as shown and described.

**DESCRIPTION**

FIG. 1 is a top, right-side perspective view of a head-mounted display device showing our new design; FIG. 2 is a left side elevation view thereof; FIG. 3 is a right-side elevation view thereof; FIG. 4 is a top plan view thereof; FIG. 5 is bottom plan view thereof; and FIG. 6 is a front elevation view thereof; and, FIG. 7 is a rear elevation view thereof.

The broken lines in the drawings represent portions of the head-mounted display device that form no part of the claimed design.

**1 Claim, 7 Drawing Sheets**

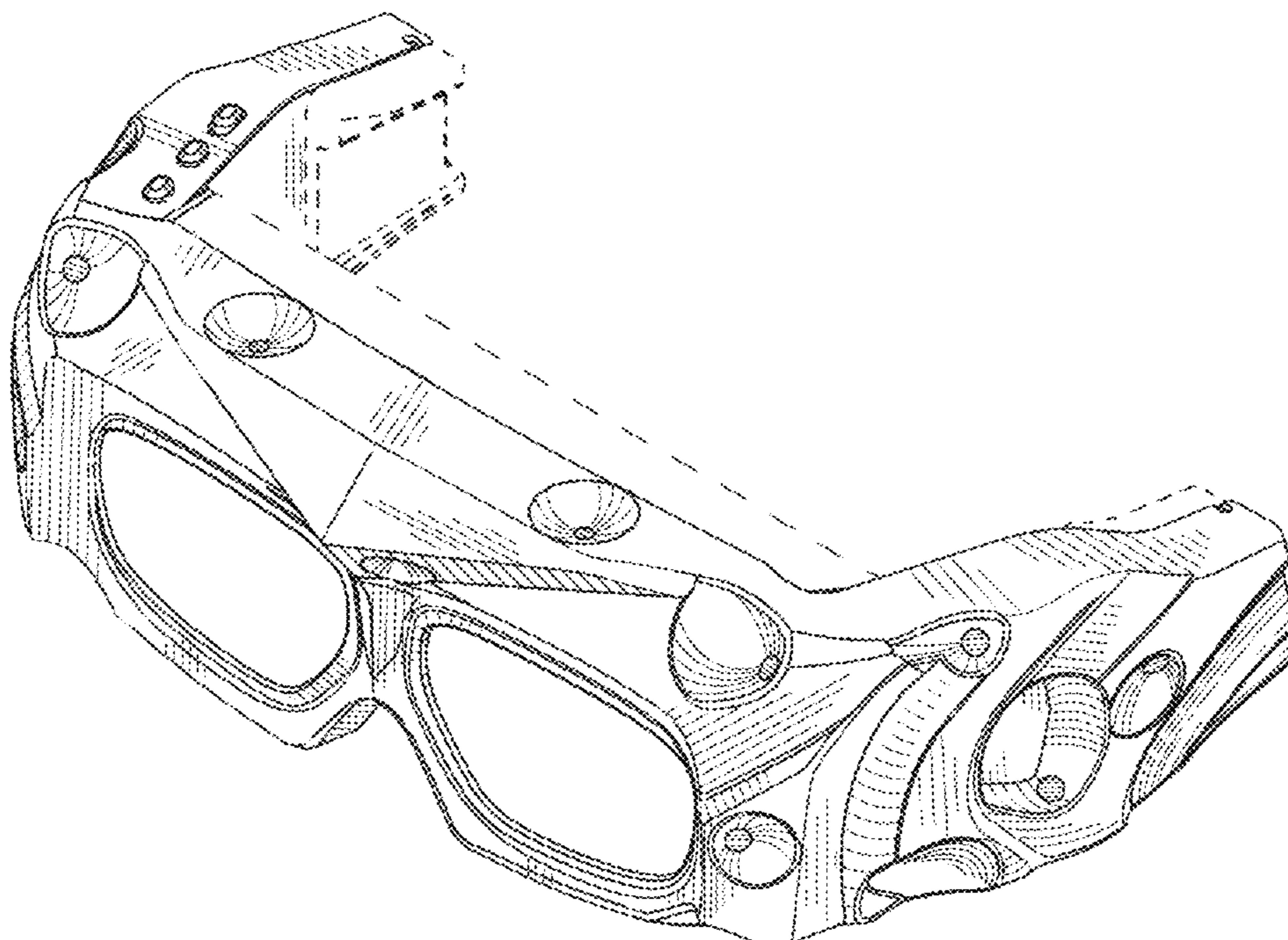

FIG. 1

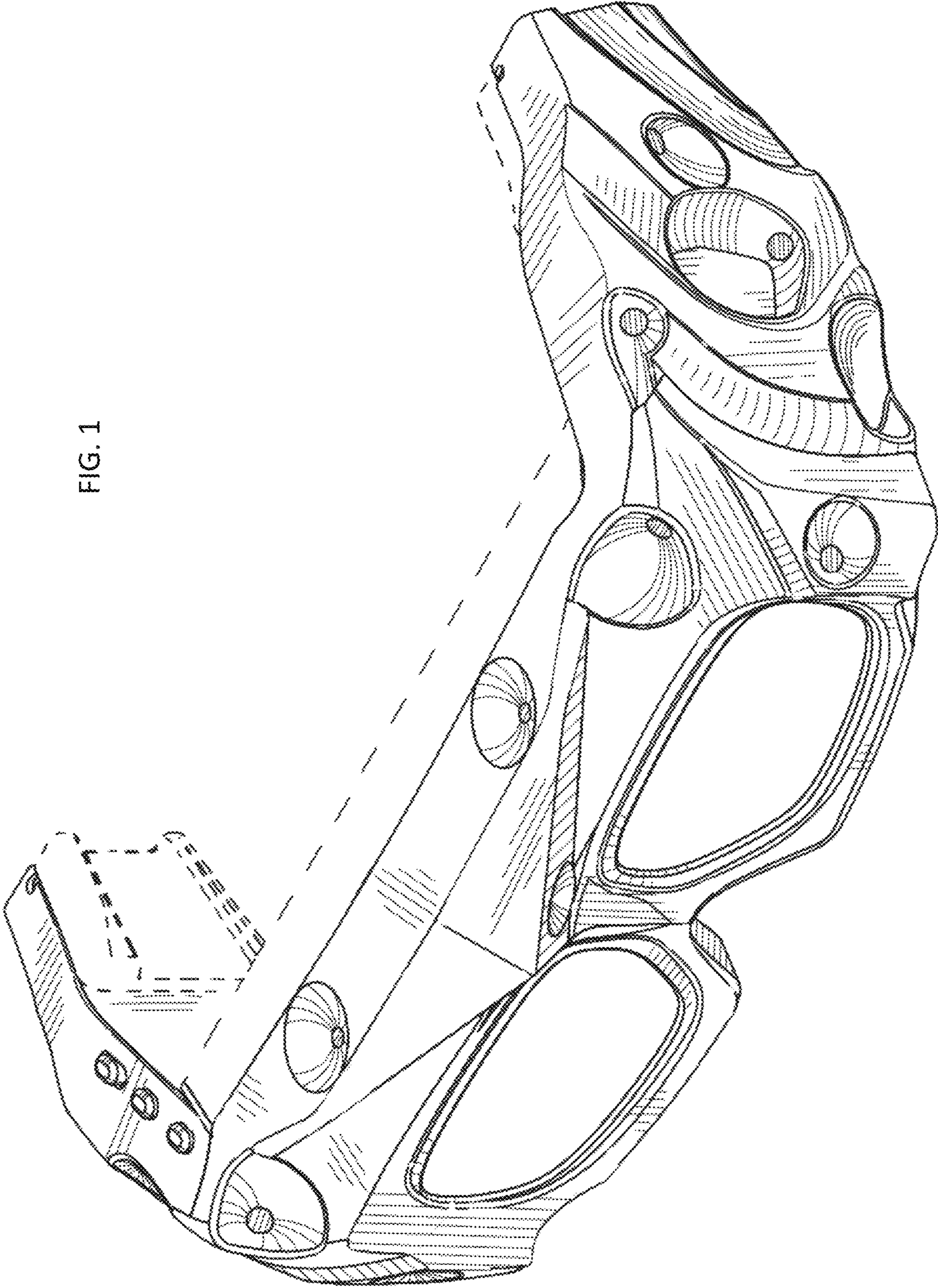

FIG. 2

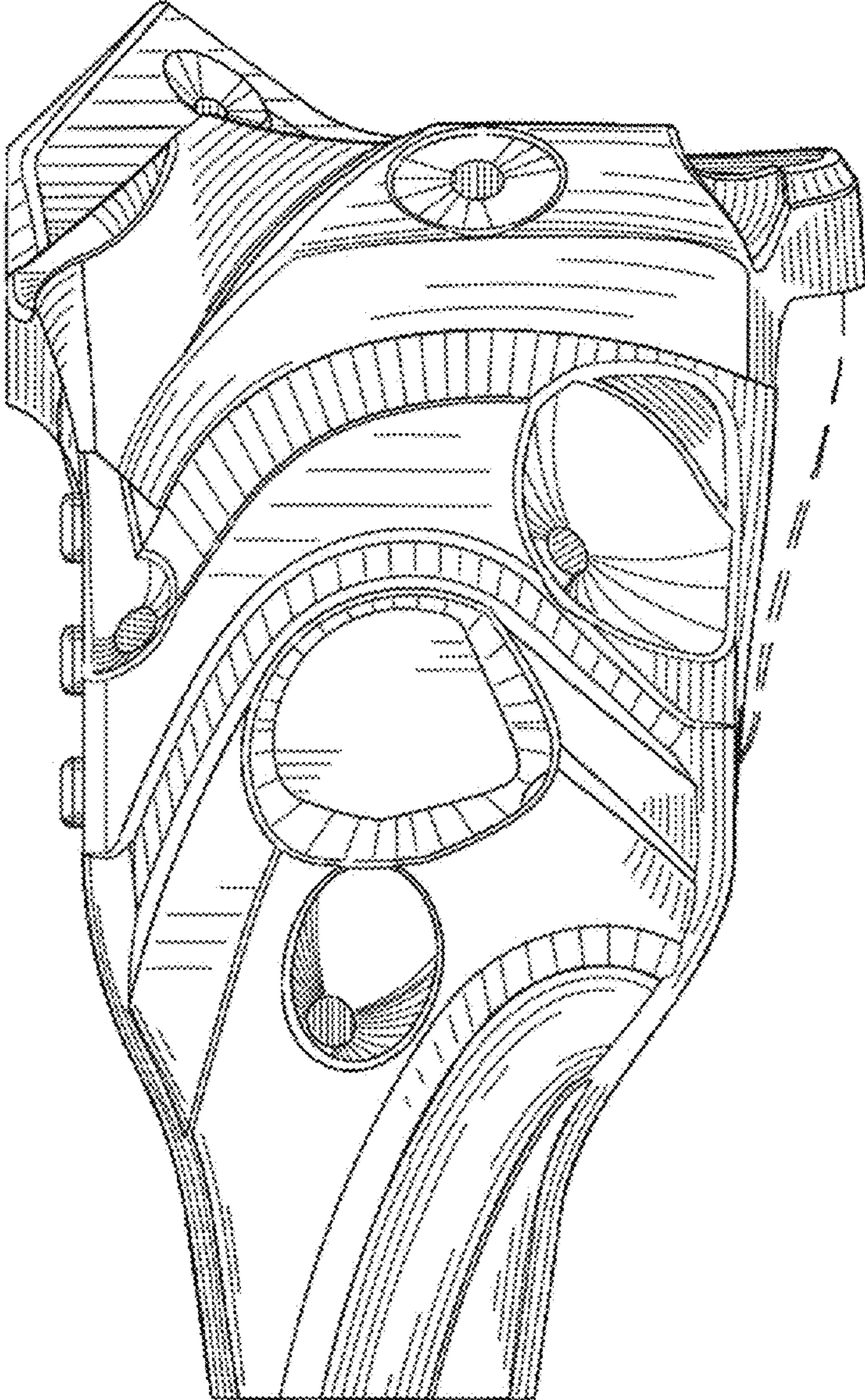

FIG. 3

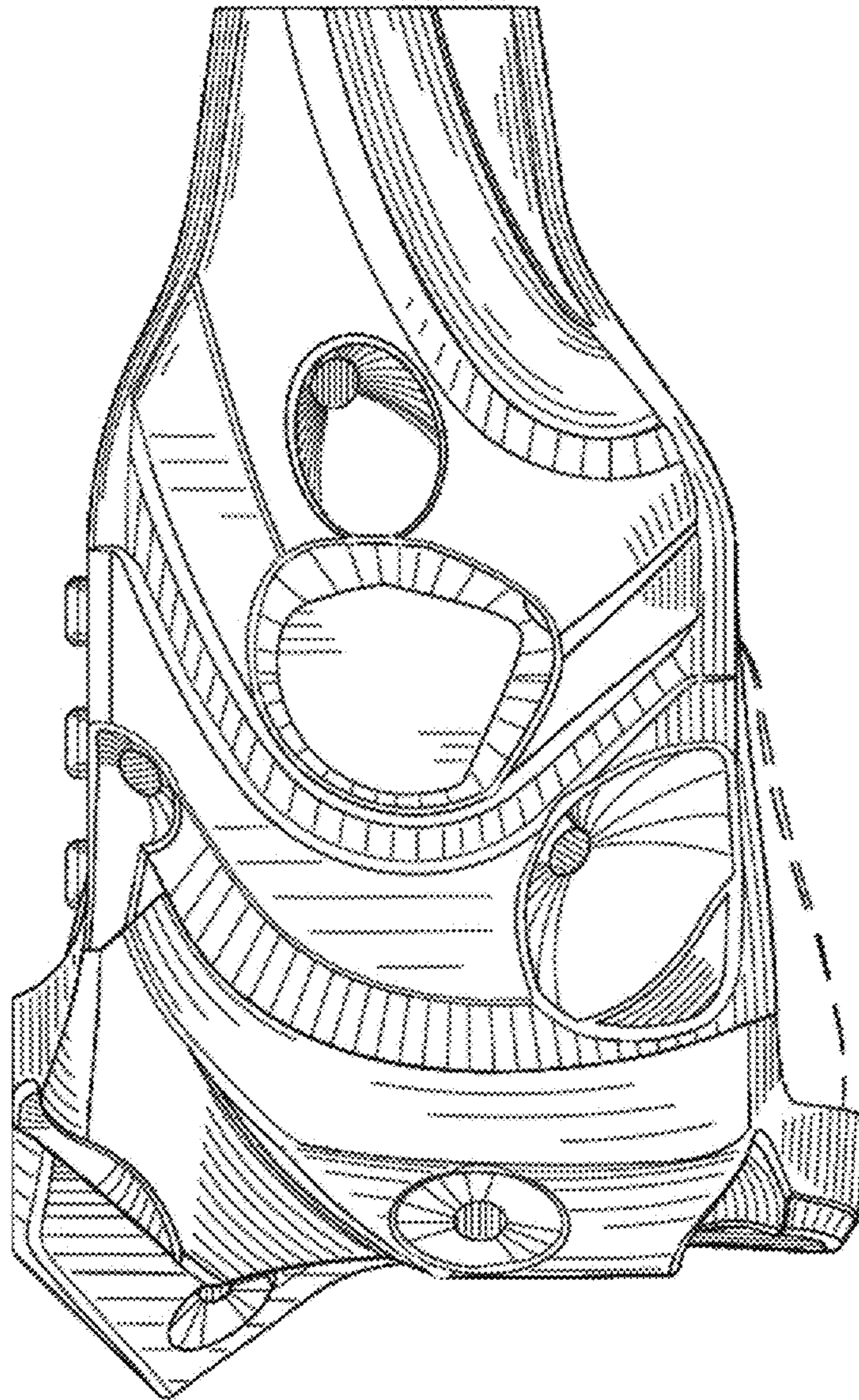

FIG. 4

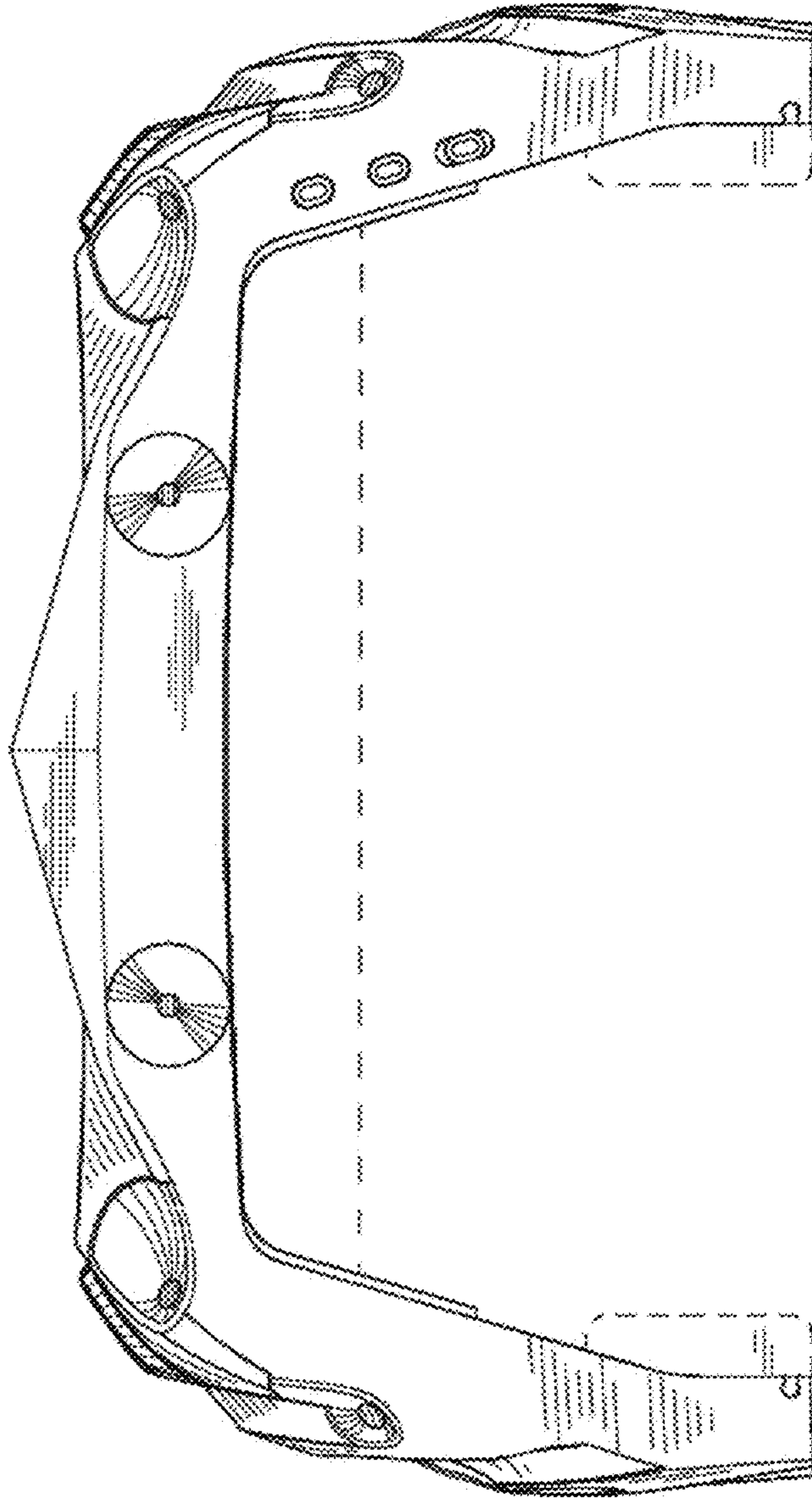

FIG. 5

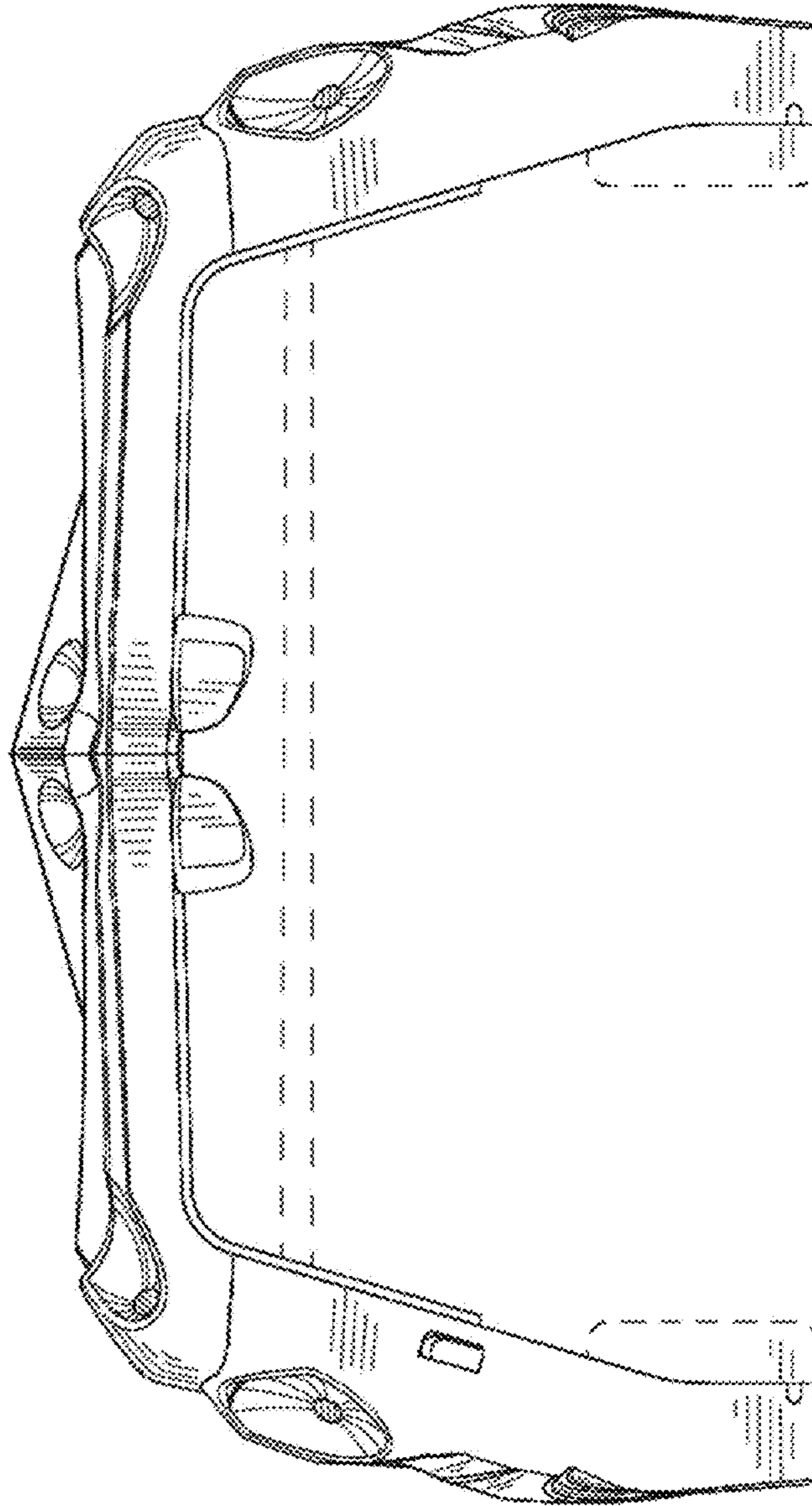

FIG. 6

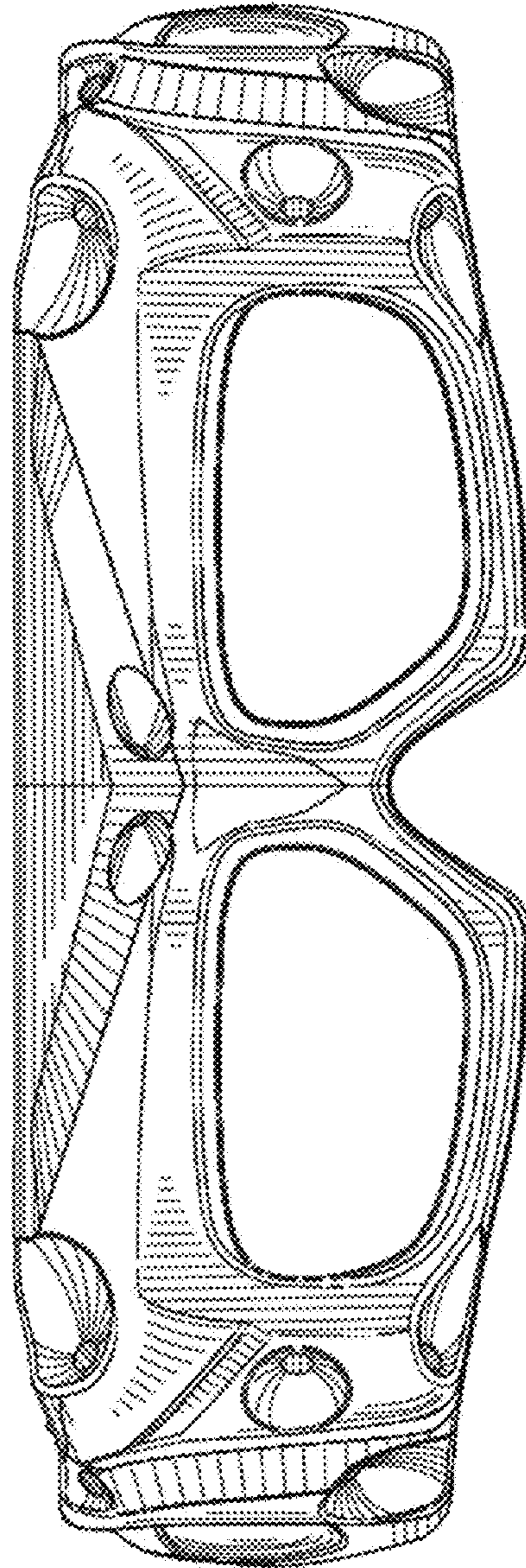

FIG. 7

