



US00D875704S

(12) **United States Design Patent**
Lee et al.

(10) **Patent No.:** **US D875,704 S**

(45) **Date of Patent:** **** Feb. 18, 2020**

(54) **MOBILE PHONE**

(71) Applicant: **LG ELECTRONICS INC.**, Seoul
(KR)

(72) Inventors: **Seungyup Lee**, Seoul (KR); **Dongsoon Kim**, Seoul (KR)

(73) Assignee: **LG ELECTRONICS INC.**, Seoul
(KR)

(**) Term: **15 Years**

(21) Appl. No.: **35/506,263**

(22) Filed: **Jun. 26, 2018**

(80) **Hague Agreement Data**

Int. Filing Date: **Jun. 26, 2018**
Int. Reg. No.: **DM/101830**
Int. Reg. Date: **Jun. 26, 2018**
Int. Reg. Pub. Date: **Dec. 28, 2018**

(30) **Foreign Application Priority Data**

Dec. 27, 2017 (KR) 30-2017-0061814

(51) **LOC (12) Cl.** **14-03**

(52) **U.S. Cl.**
USPC **D14/138 AB**

(58) **Field of Classification Search**
USPC D14/138 AB
CPC H04M 1/0214; H04M 1/0216
See application file for complete search history.

(56) **References Cited**

U.S. PATENT DOCUMENTS

D449,605 S * 10/2001 Schebesch D14/138 AB
D488,154 S * 4/2004 Lovelady D14/138 AB

D488,453 S * 4/2004 Chang D14/138 AB
D507,251 S * 7/2005 Burns D14/138 AB
D519,966 S * 5/2006 Salmi D14/138 AB
D551,643 S * 9/2007 Kim D14/138 AB
D558,721 S * 1/2008 Cha D14/138 AB
D559,218 S * 1/2008 Park D14/138 AB
D573,575 S * 7/2008 Song D14/138 AB

* cited by examiner

Primary Examiner — Michael A. Pratt

(74) *Attorney, Agent, or Firm* — Birch, Stewart, Kolasch & Birch, LLP

(57) **CLAIM**

The ornamental design for a mobile phone, as shown and described.

DESCRIPTION

- 1. Mobile phone
- 1.1 : Perspective
- 1.2 : Front
- 1.3 : Back
- 1.4 : Left
- 1.5 : Right
- 1.6 : Top
- 1.7 : Bottom
- 1.8 : Reference view

The broken lines depict portions of the mobile phone that form no part of the claimed design; reproduction 1.1 is a front perspective view of the mobile phone; reproduction 1.2 is a front view thereof; reproduction 1.3 is a back view thereof; reproduction 1.4 is a left view thereof; reproduction 1.5 is a right view thereof; reproduction 1.6 is a top view thereof; reproduction 1.7 is a bottom view thereof; reproduction 1.8 is a reference view in condition that the claimed design has been opened.

1 Claim, 8 Drawing Sheets

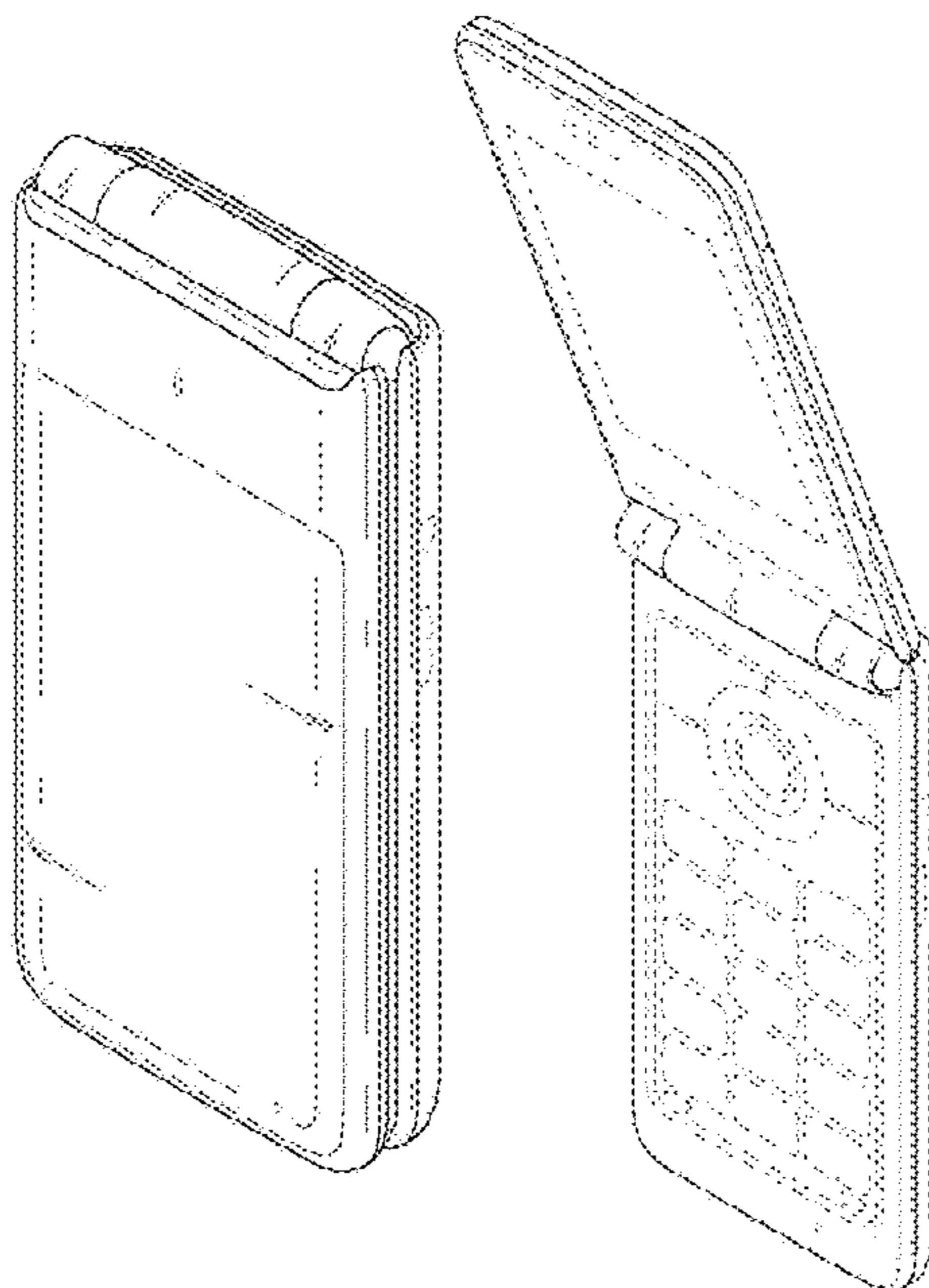

1.1

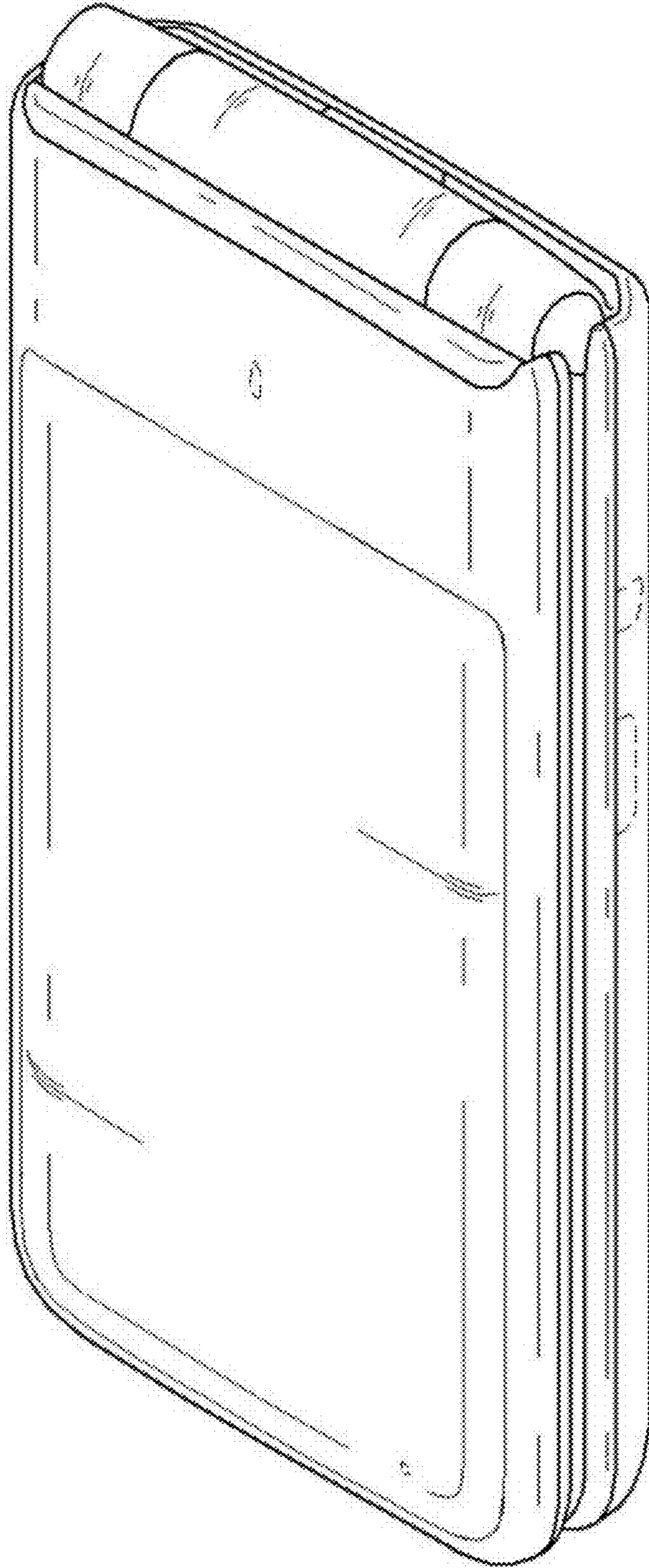

1.2

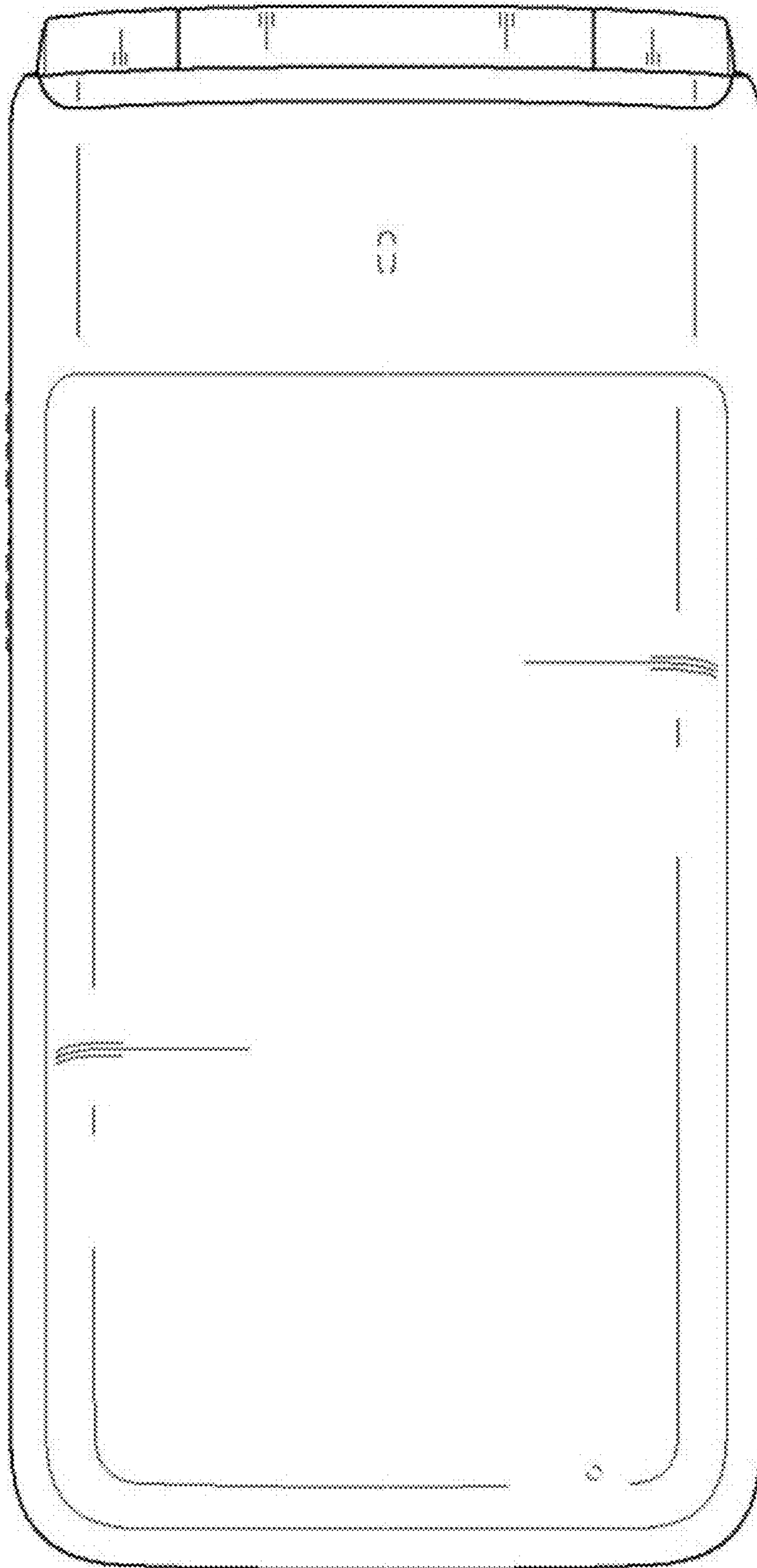

1.3

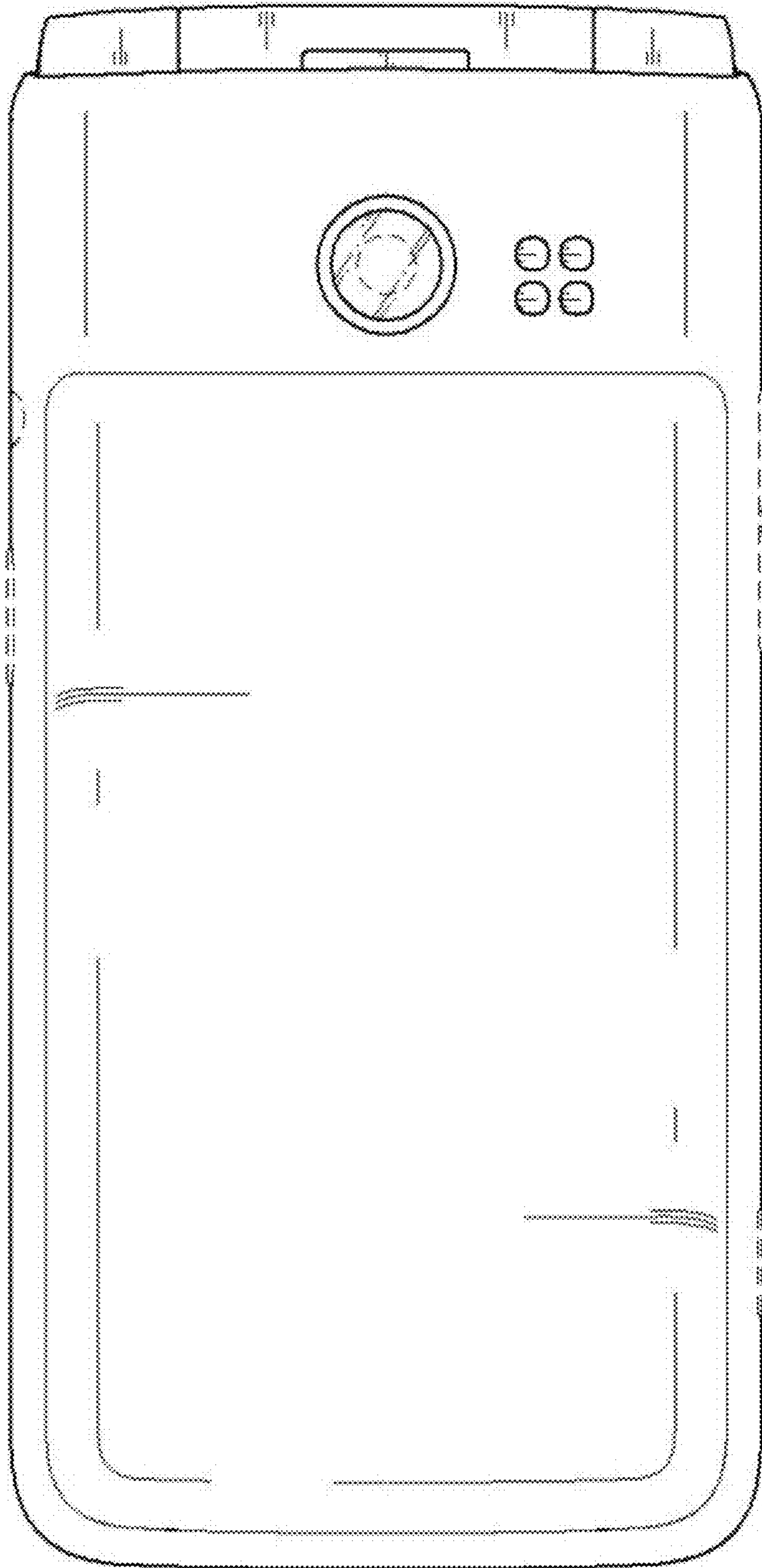

1.4

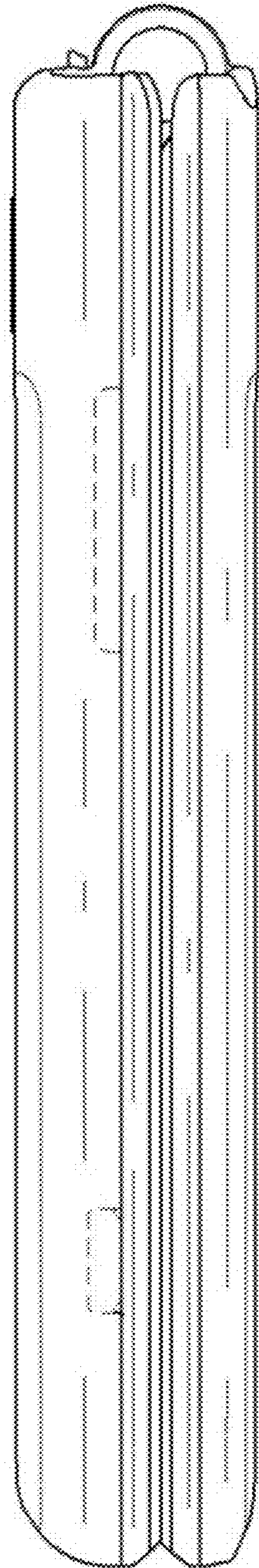

1.5

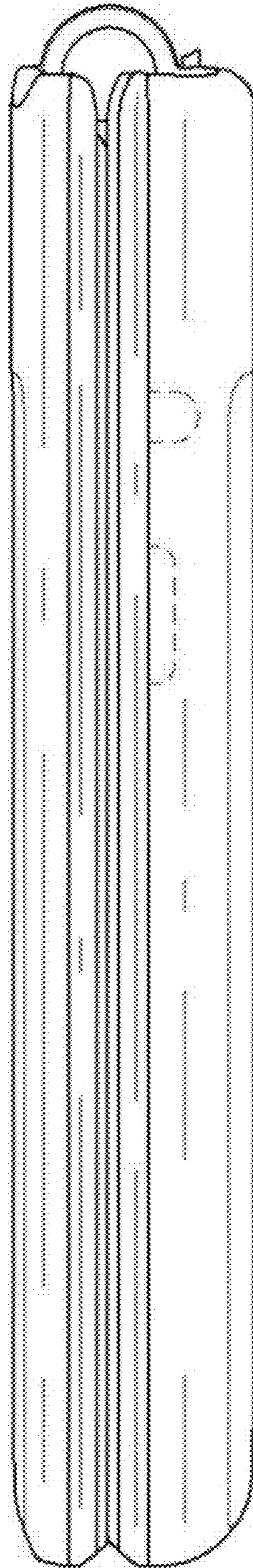

1.6

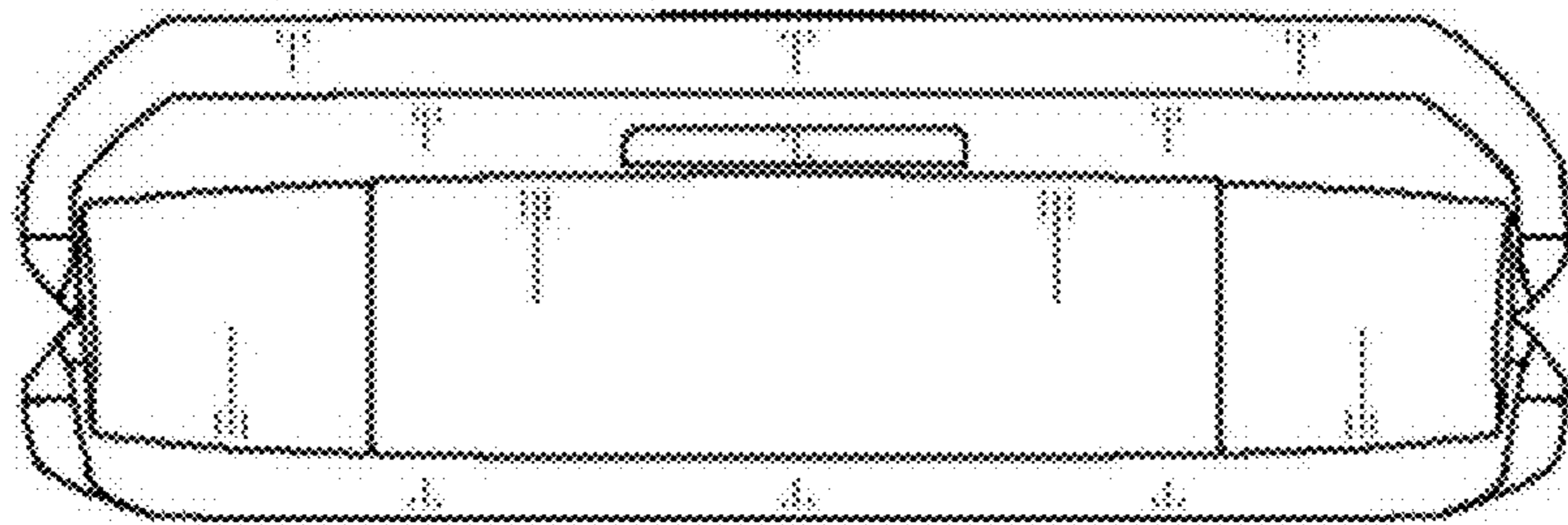

1.7

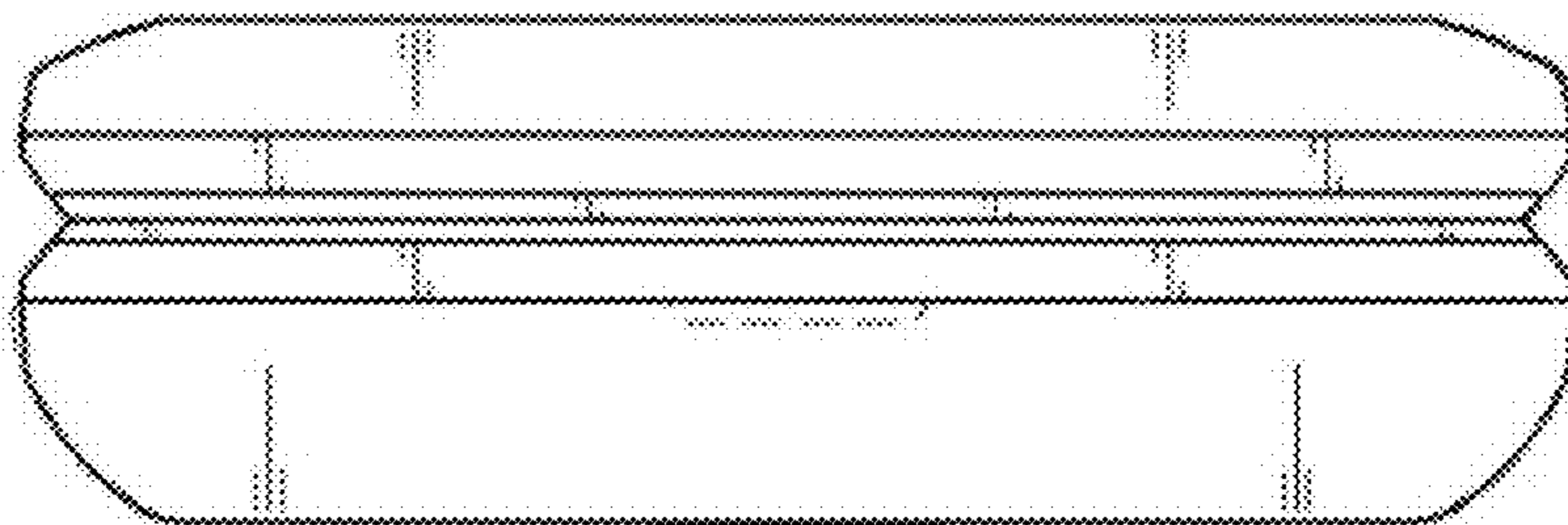

1.8

