



US00D875668S

(12) **United States Design Patent**  
**Jiao**

(10) **Patent No.:** **US D875,668 S**

(45) **Date of Patent:** **\*\* Feb. 18, 2020**

(54) **BATTERY CASE**

(71) Applicant: **Zhongpeng Jiao**, Henan (CN)

(72) Inventor: **Zhongpeng Jiao**, Henan (CN)

(\*\*) Term: **15 Years**

(21) Appl. No.: **29/645,275**

(22) Filed: **Apr. 25, 2018**

(51) **LOC (12) Cl.** ..... **13-02**

(52) **U.S. Cl.**  
USPC ..... **D13/103**

(58) **Field of Classification Search**

USPC ..... D13/103-110, 118, 119, 184, 199;  
D14/251, 253, 432, 434  
CPC ..... Y02E 60/10; Y02E 60/12; Y02E 60/122;  
Y02E 60/124; Y02E 60/50; H01M 2/02;  
H01M 2/022; H01M 2/0202; H01M  
2/0207; H01M 2/0212; H01M 2/1061;  
H01M 2/1022; H01M 2/1055; H01M  
2/1066; H01M 2/105; H01M 2/20; H01M  
2/202; H01M 2/204; H01M 2/206; H01M  
10/44; H01M 10/46; H01M 10/465;  
H01M 10/482; H01M 2200/30; H01M  
2250/30; H01M 2250/40; H02J 7/00;  
H02J 7/0003; H02J 7/0011; H02J 7/0013;  
H02J 7/0054; H02J 7/0055; H02J 7/0057;  
H02J 2007/0062

See application file for complete search history.

(56) **References Cited**

**U.S. PATENT DOCUMENTS**

D547,264 S \* 7/2007 Kondo ..... D13/103  
D609,178 S \* 2/2010 Mack ..... D13/104  
D609,179 S \* 2/2010 Mack ..... D13/104  
D609,631 S \* 2/2010 Mack ..... D13/104

D633,862 S \* 3/2011 Qualls ..... D13/104  
D633,863 S \* 3/2011 Qualls ..... D13/106  
D637,156 S \* 5/2011 Yoon ..... D13/119  
D720,291 S \* 12/2014 Liu ..... D13/119  
D736,155 S \* 8/2015 Alesi ..... D13/110  
D762,573 S \* 8/2016 Behar ..... D13/110  
D766,181 S \* 9/2016 Cooper ..... D13/119  
D815,034 S \* 4/2018 Zhao ..... D13/107  
2007/0015039 A1\* 1/2007 Homma ..... H01M 8/004  
429/457  
2010/0209799 A1\* 8/2010 Ogawa ..... H01M 8/0204  
429/457  
2011/0039169 A1\* 2/2011 Cleland ..... H01M 8/04089  
429/414  
2011/0045378 A1\* 2/2011 Miyazaki ..... H01M 8/0206  
429/457  
2015/0214556 A1\* 7/2015 Romand ..... B63G 8/08  
29/825  
2018/0130990 A1\* 5/2018 Liu ..... H01M 2/1077

\* cited by examiner

*Primary Examiner* — Rosemary K Tarcza

*Assistant Examiner* — Christy M Nemeth

(74) *Attorney, Agent, or Firm* — Justin Lampel

(57) **CLAIM**

The ornamental design for a battery case, as shown and described.

**DESCRIPTION**

FIG. 1 is a perspective view of a battery case showing my new design;

FIG. 2 is a front side view thereof;

FIG. 3 is a rear side view thereof;

FIG. 4 is a right side view thereof;

FIG. 5 is a left side view thereof;

FIG. 6 is a bottom plan view thereof; and,

FIG. 7 is a top plan view thereof.

**1 Claim, 7 Drawing Sheets**

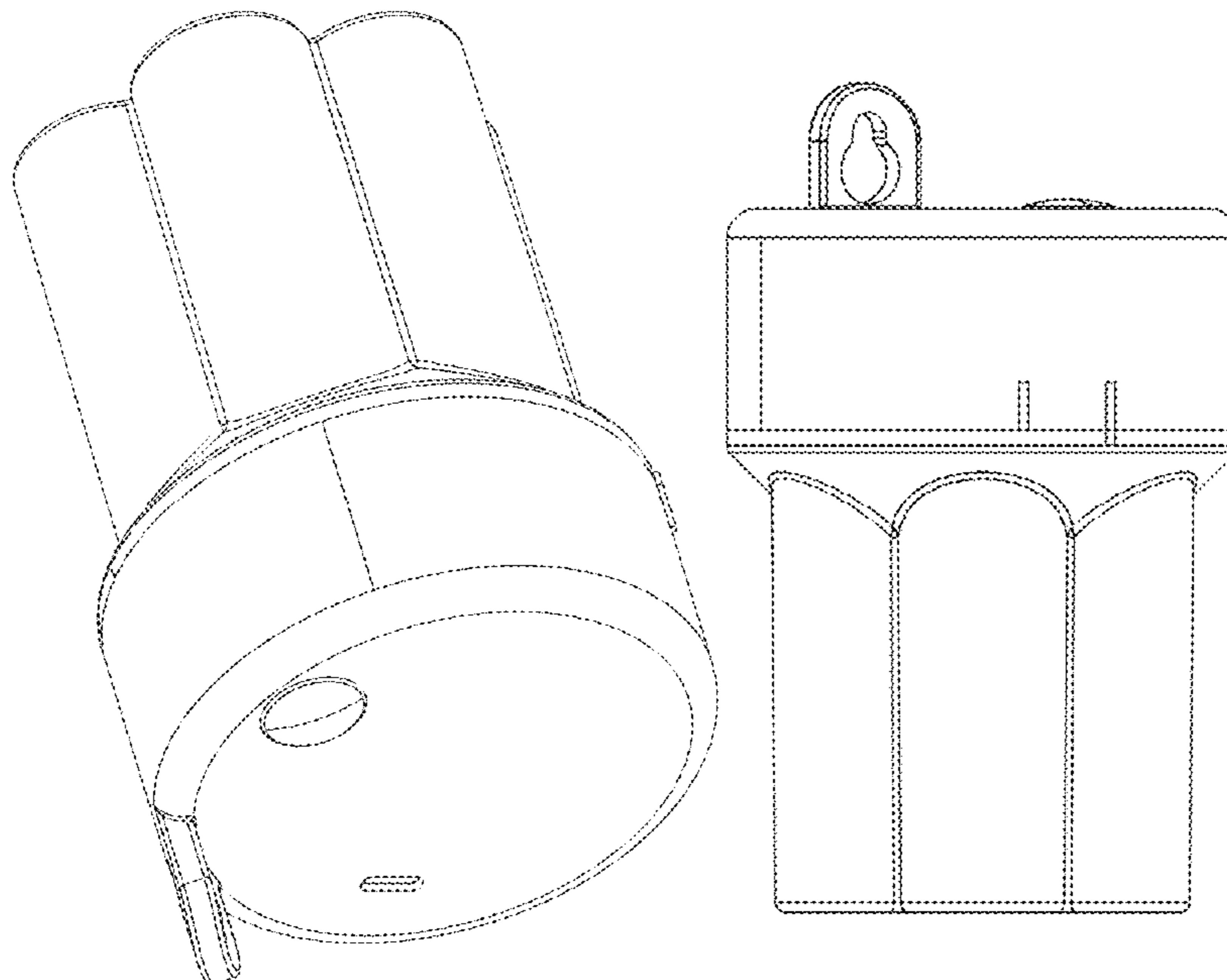

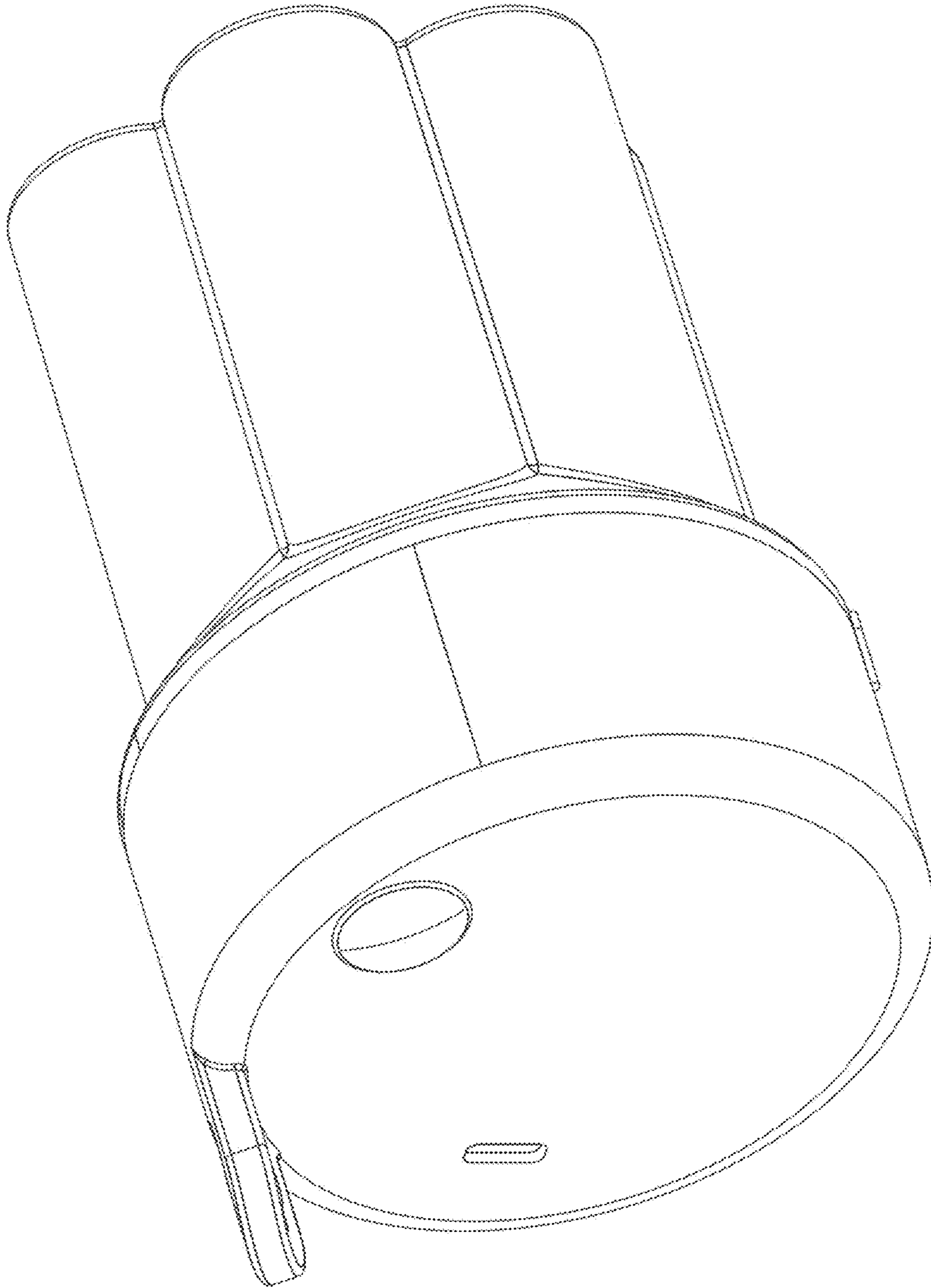

FIG. 1

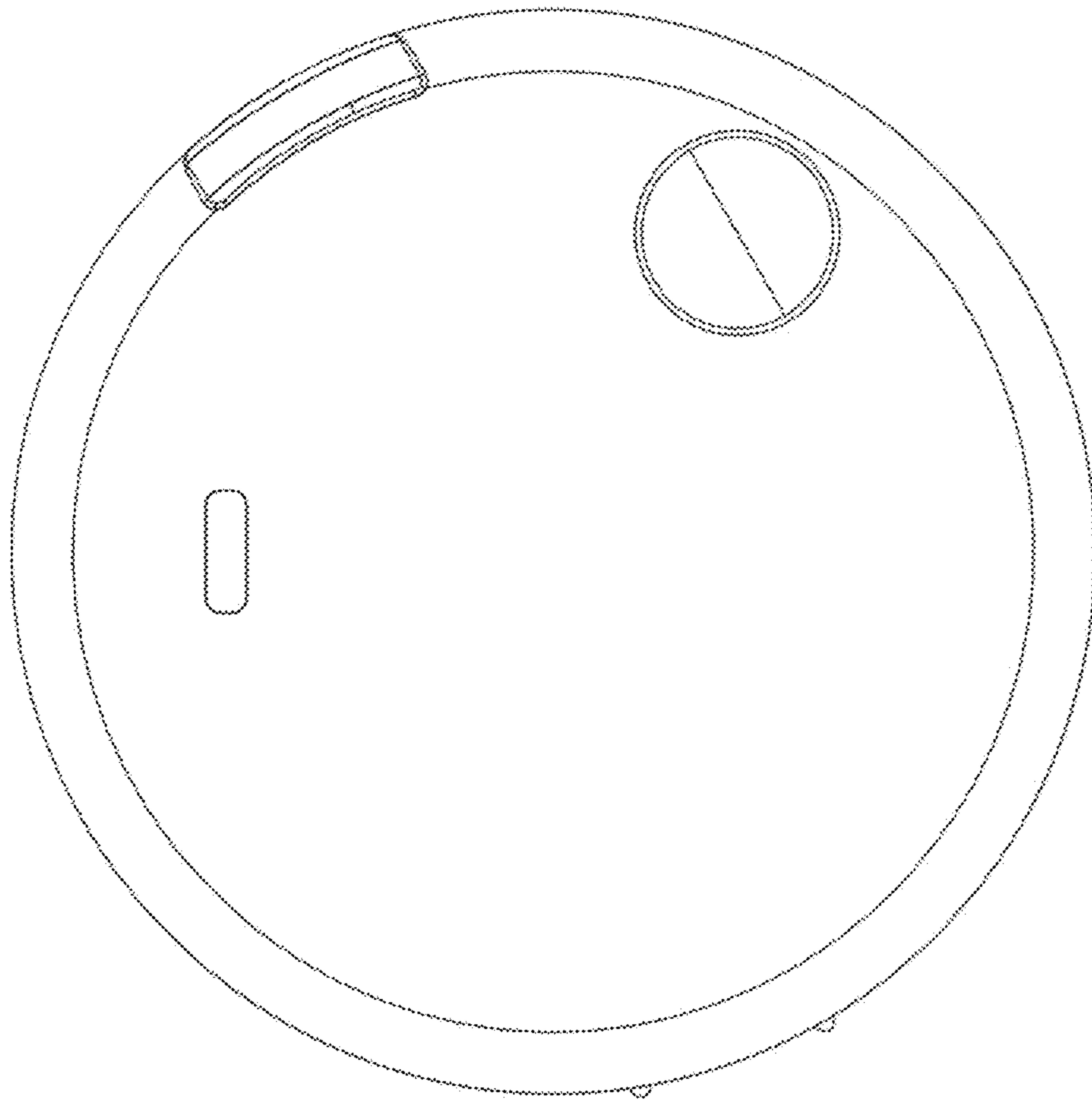

FIG. 2

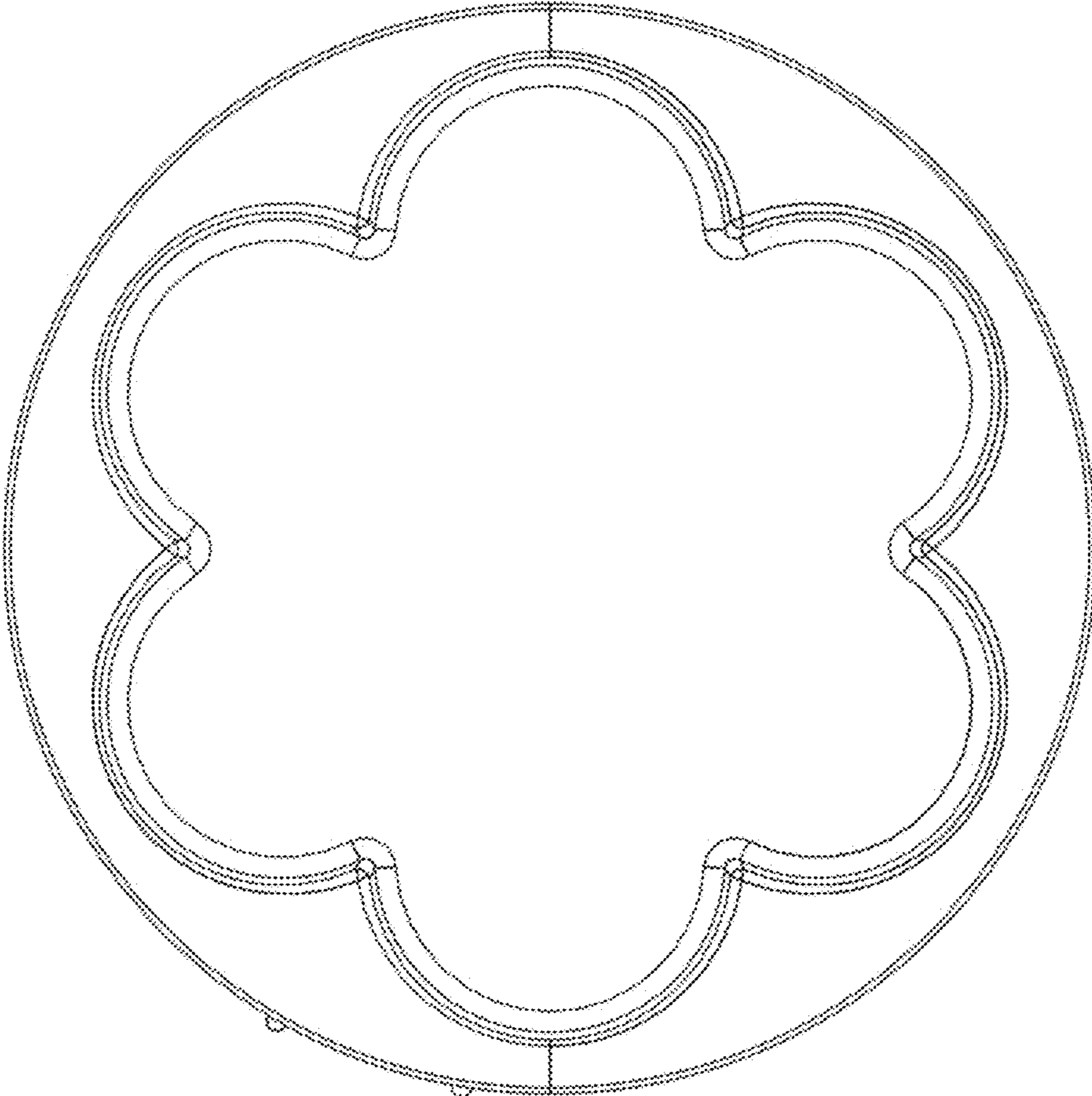

FIG. 3

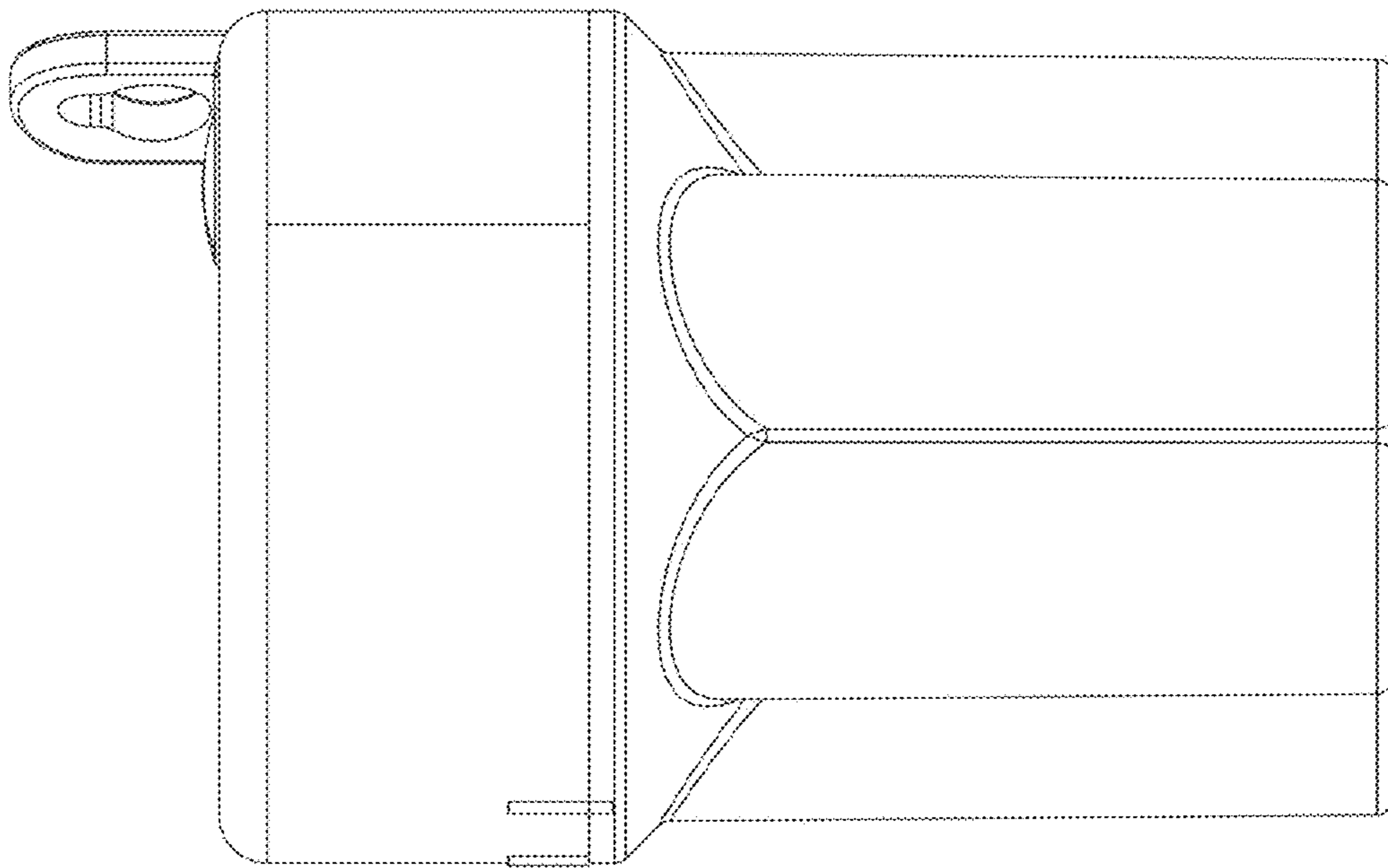

FIG. 4

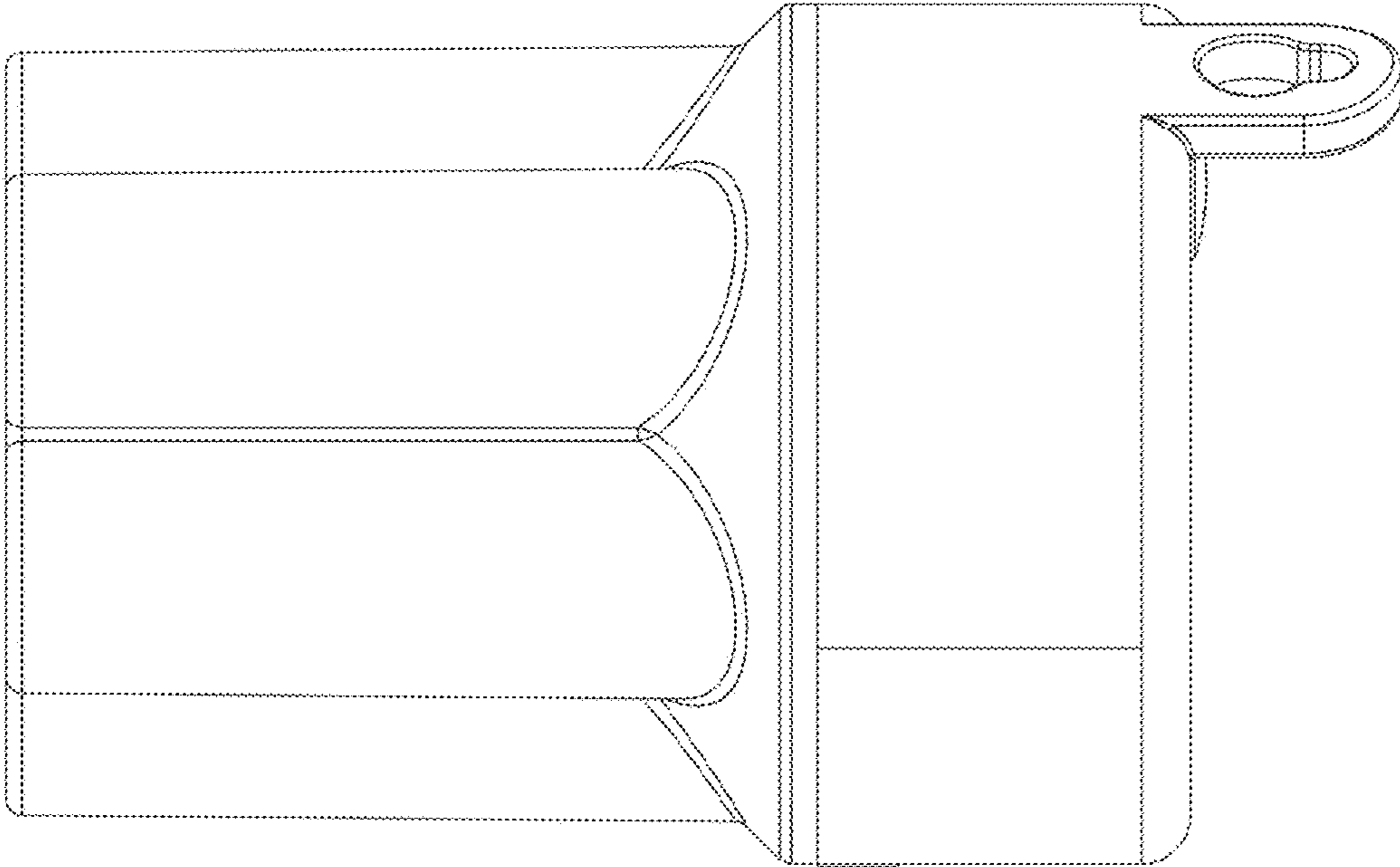

FIG. 5

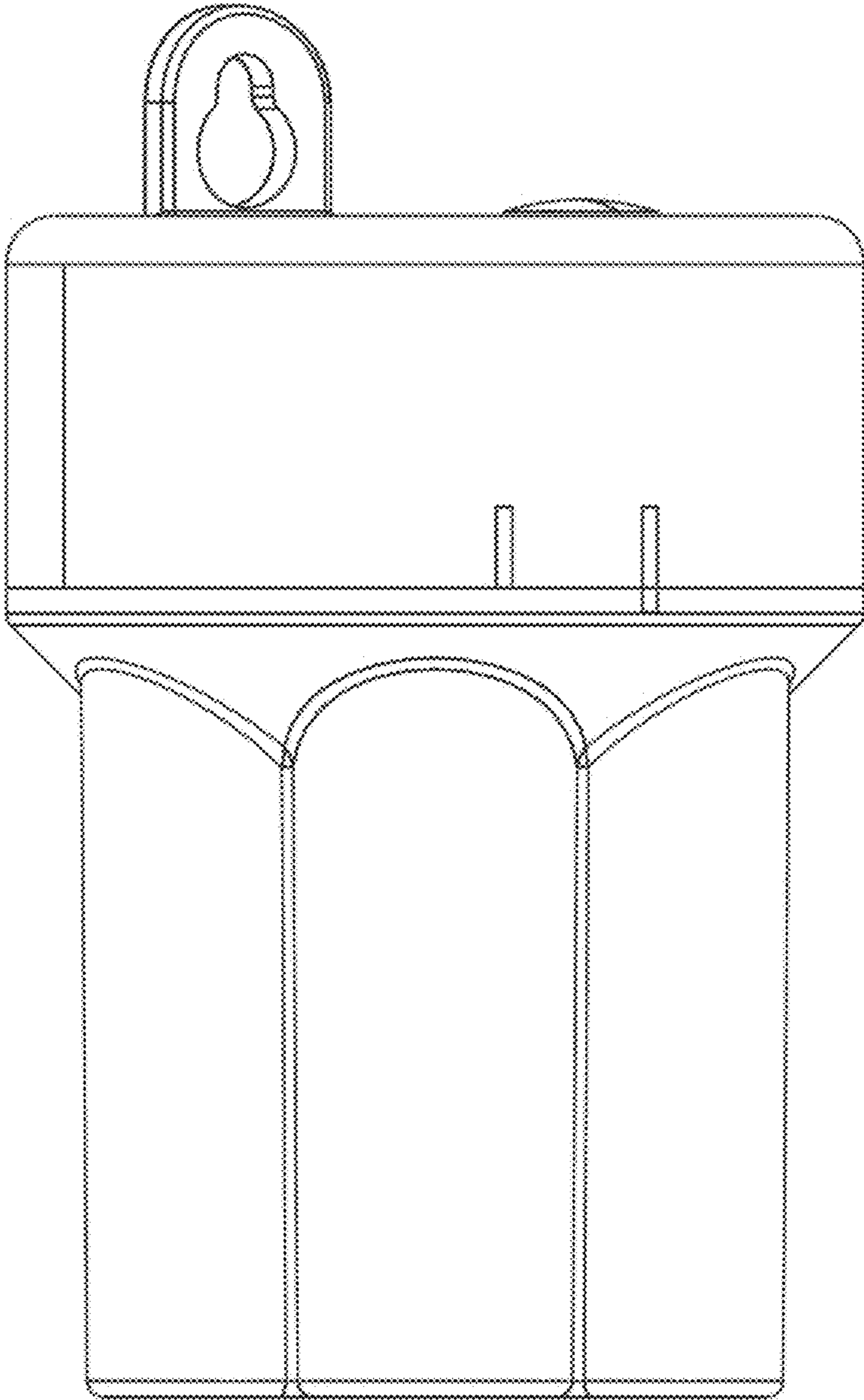

FIG. 6

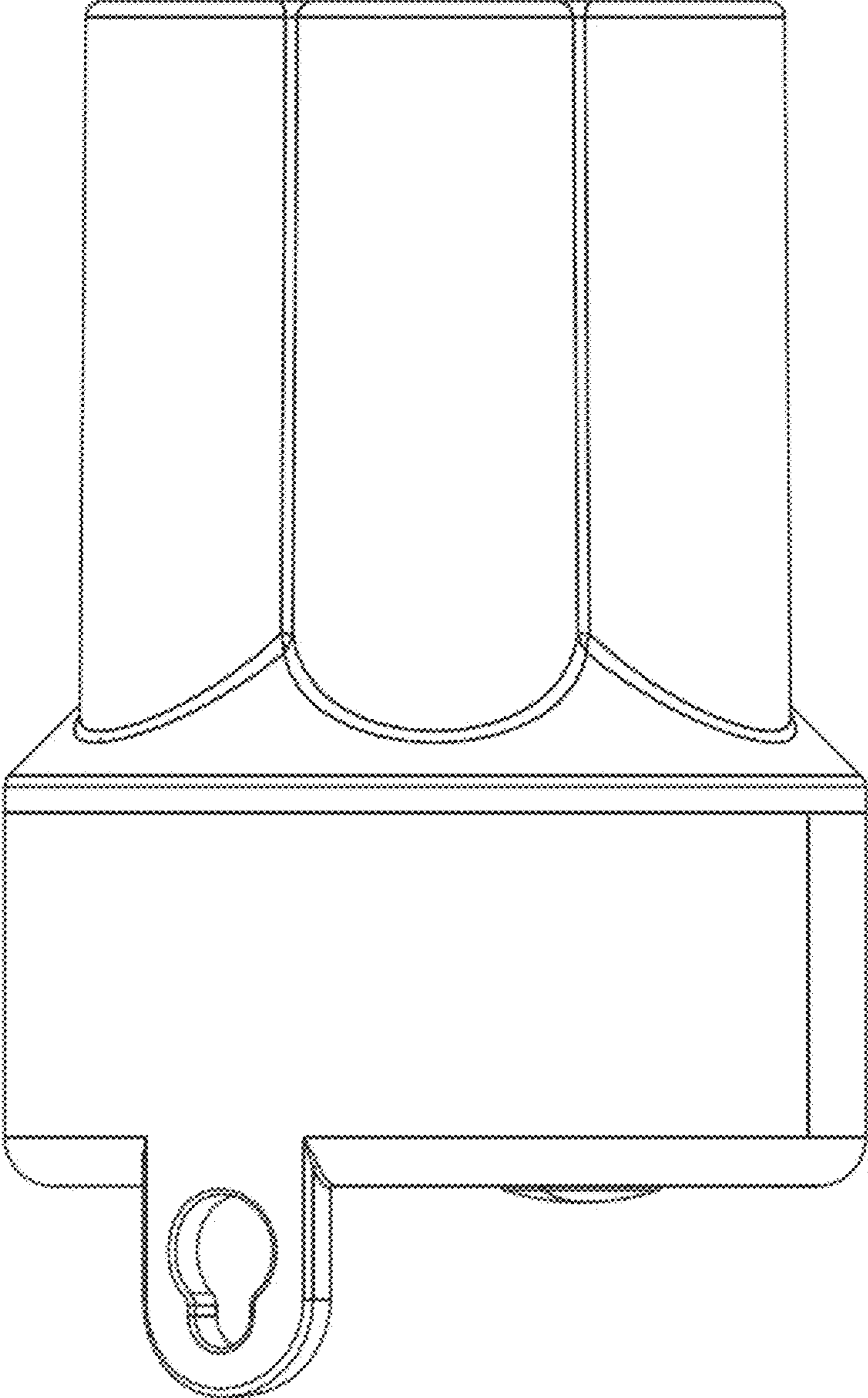

FIG. 7