



US00D875658S

(12) **United States Design Patent** (10) **Patent No.:** **US D875,658 S**
Takemori (45) **Date of Patent:** **** *Feb. 18, 2020**

(54) **AUTOMOBILE TIRE**

FOREIGN PATENT DOCUMENTS

(71) Applicant: **THE YOKOHAMA RUBBER CO., LTD.**, Minato-ku, Tokyo (JP)

JP D1543483 S 2/2016
JP D1543484 S 2/2016

(72) Inventor: **Ryohei Takemori**, Hiratsuka (JP)

OTHER PUBLICATIONS

(73) Assignee: **THE YOKOHAMA RUBBER CO., LTD.**, Minato-ku, Tokyo (JP)

Yokohama Geolandar [Apr. 12, 2019] found online [Apr. 12, 2019]—<https://www.amazon.com/Yokohama-Tires-05521-Geolandar-G055e/dp/B0110A0IR4>.*

(*) Notice: This patent is subject to a terminal disclaimer.

(Continued)

(**) Term: **15 Years**

Primary Examiner — Lakiya G Rogers
Assistant Examiner — John A Voytek

(21) Appl. No.: **29/656,735**

(74) *Attorney, Agent, or Firm* — Banner & Witcoff, Ltd.

(22) Filed: **Jul. 16, 2018**

(57) **CLAIM**

(30) **Foreign Application Priority Data**

The ornamental design for an automobile tire, as shown and described.

Jan. 16, 2018 (JP) 2018-000609

(51) **LOC (12) Cl.** **12-15**

DESCRIPTION

(52) **U.S. Cl.**
USPC **D12/588**

(58) **Field of Classification Search**
USPC D12/568, 574–604
CPC Y10T 152/10027; B60C 1/0016; B60C 11/0306; B60C 11/0302; B60C 3/06; B60C 9/17

See application file for complete search history.

FIG. 1 is a perspective view of an automobile tire showing my new design;
FIG. 2 is a front view thereof;
FIG. 3 is a rear view thereof;
FIG. 4 is a right side view thereof;
FIG. 5 is a left side view thereof;
FIG. 6 is a top view thereof;
FIG. 7 is a bottom view thereof;
FIG. 8 is an enlarged perspective view thereof taken at a portion defined by lines 8-8 shown in FIG. 1;
FIG. 9 is an enlarged view thereof taken at a portion defined by lines 9-9 shown in FIG. 2; and,
FIG. 10 is an end view thereof taken at a portion defined by lines 10-10 shown in FIG. 9.
In the drawings, the broken lines depict environmental subject matter only and form no part of the claimed design. The dot and dashed lines represents a boundary between the claimed portion and the non-claimed portion.

(56) **References Cited**

U.S. PATENT DOCUMENTS

D583,310 S	*	12/2008	Dixon	D12/588
D586,733 S	*	2/2009	Shinohara	D12/588
D604,692 S	*	11/2009	Ebiko	D12/587
D729,154 S	*	5/2015	Kwak	D12/588
D749,039 S	*	2/2016	Yamakawa	D12/600
D761,190 S	*	7/2016	Wang	D12/586
D781,778 S	*	3/2017	Shinzawa	D12/586
D782,400 S	*	3/2017	De Giacco	D12/584
D787,429 S	*	5/2017	Shinzawa	D12/586

(Continued)

1 Claim, 10 Drawing Sheets

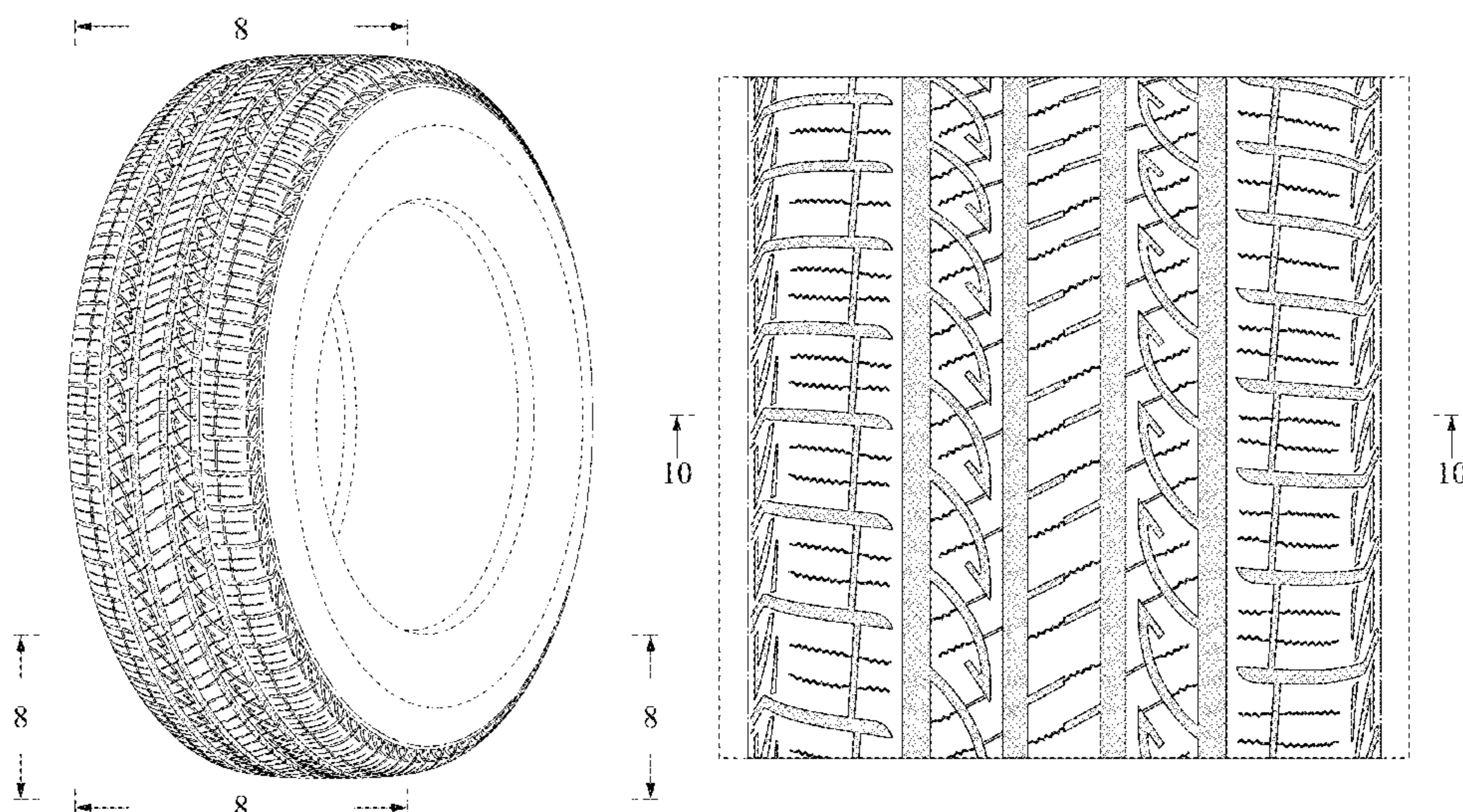

(56)

References Cited

U.S. PATENT DOCUMENTS

D795,171 S * 8/2017 Suzuki D12/586
D813,148 S * 3/2018 Umstot D12/588
D813,149 S * 3/2018 Dixon D12/588

OTHER PUBLICATIONS

May 8, 2018—(JP) Notification of Reasons for Refusal—App
2018-000609.

May 8, 2018—(JP) Notification of Reasons for Refusal—App
2018-000608.

Jul. 16, 2018—(US) Co-pending U.S. Appl. No. 29/656,736.

* cited by examiner

FIG. 1

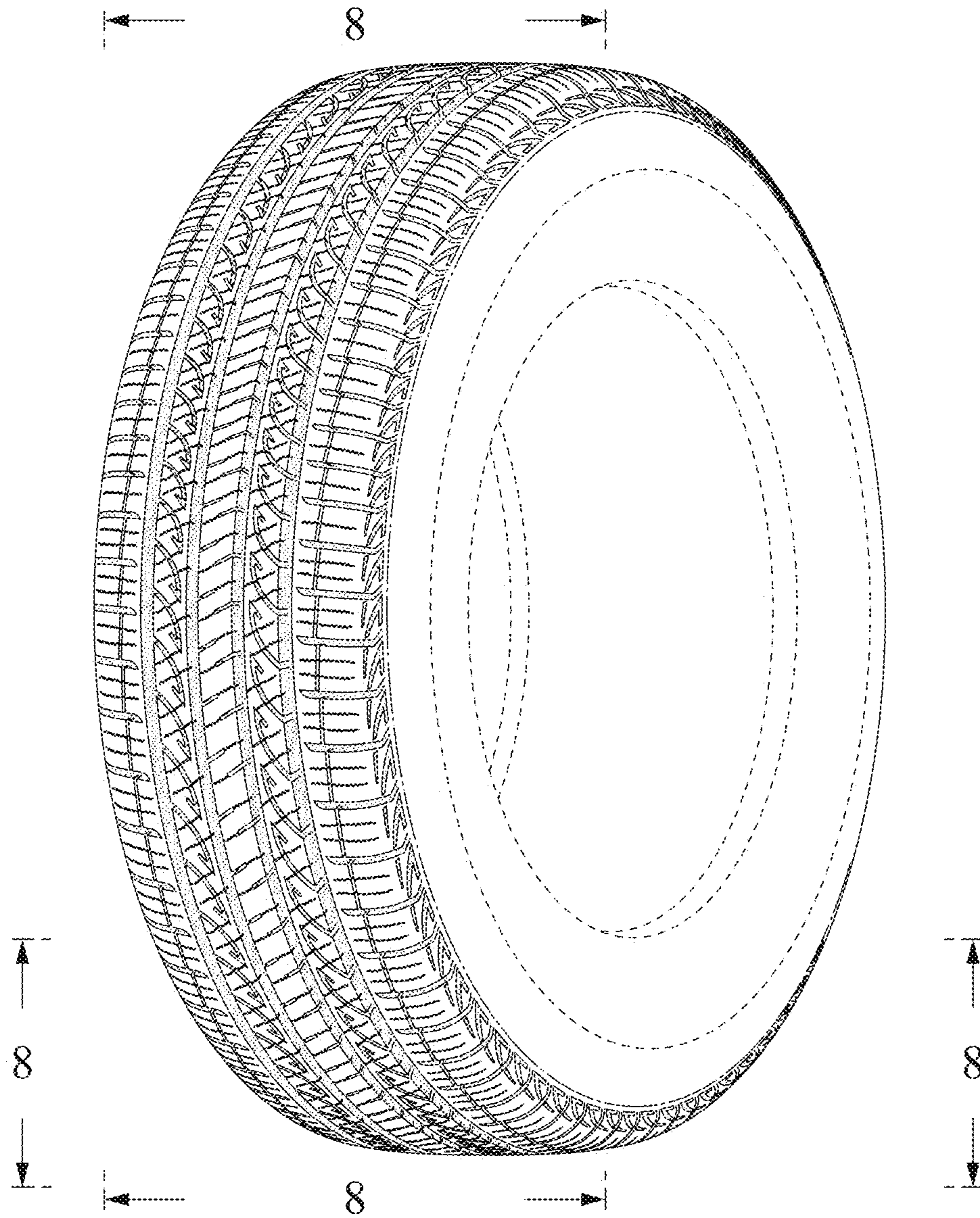

FIG. 2

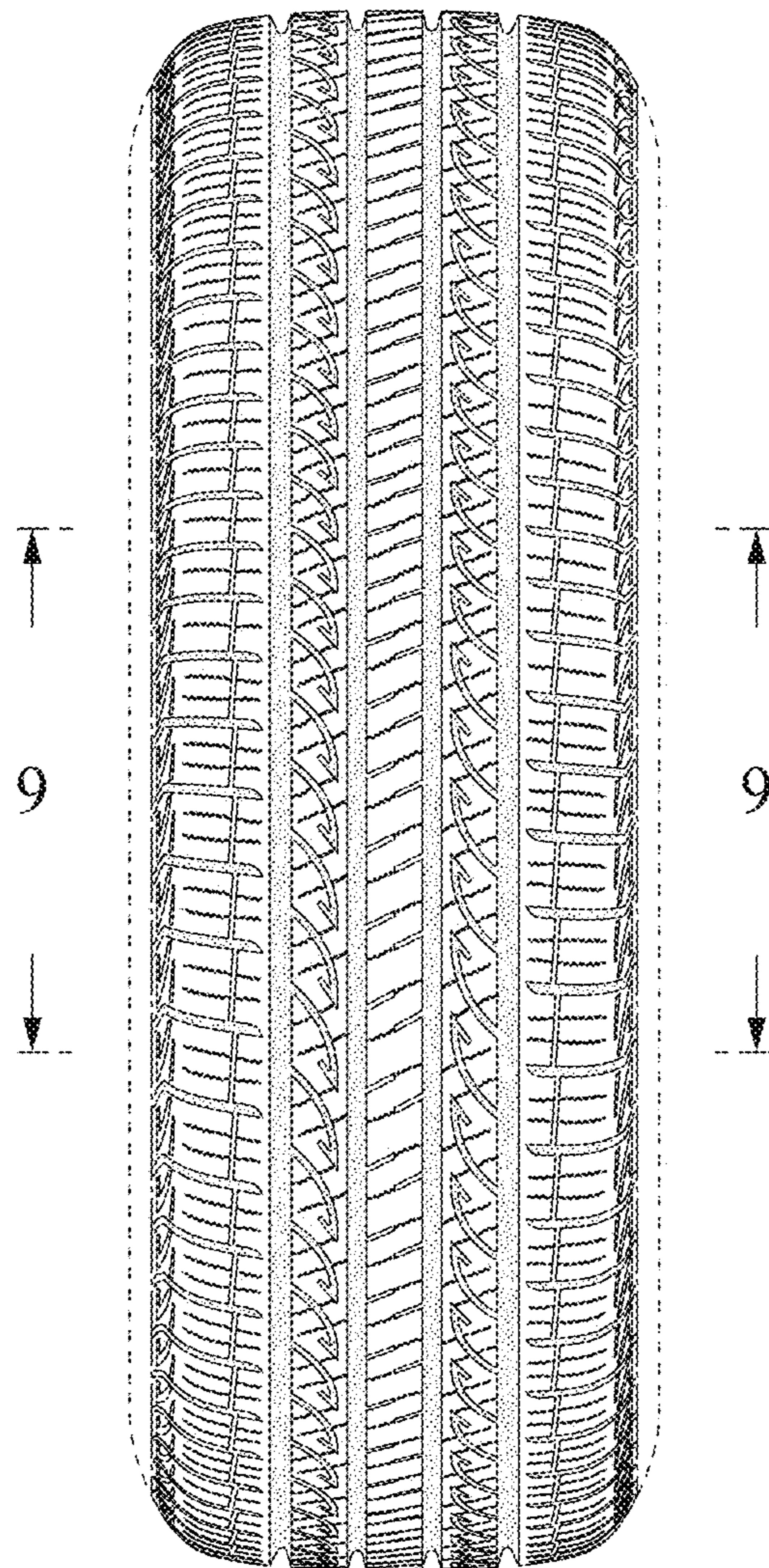

FIG. 3

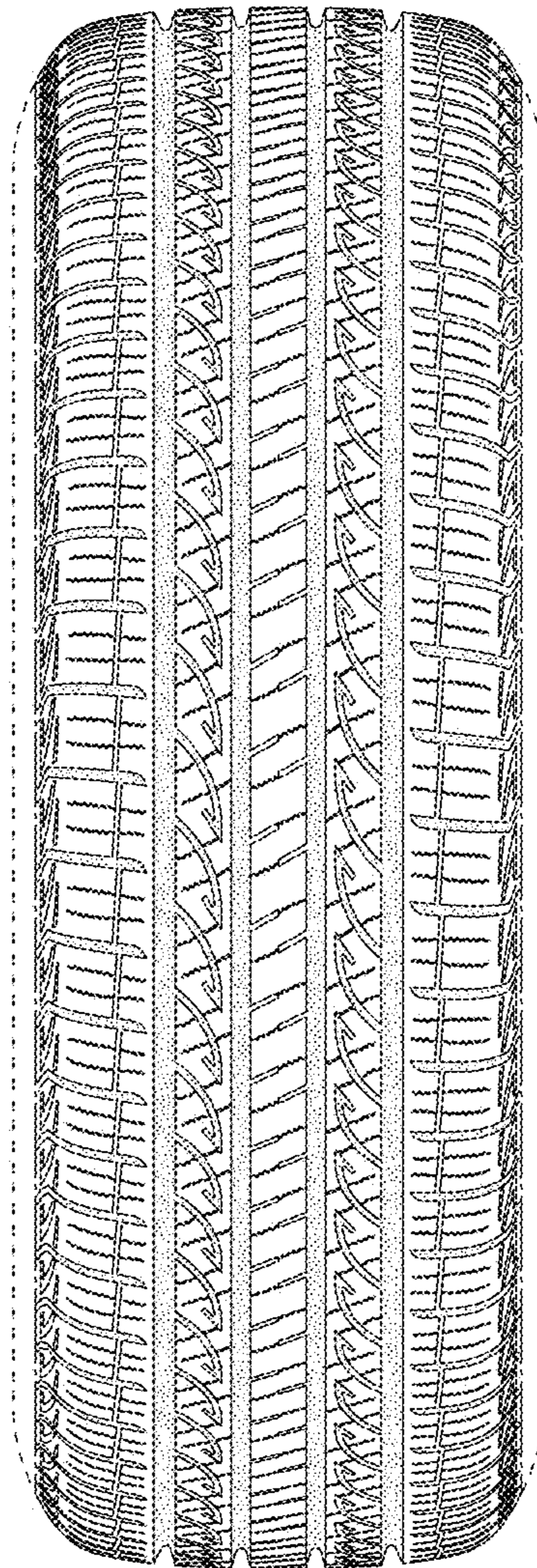

FIG. 4

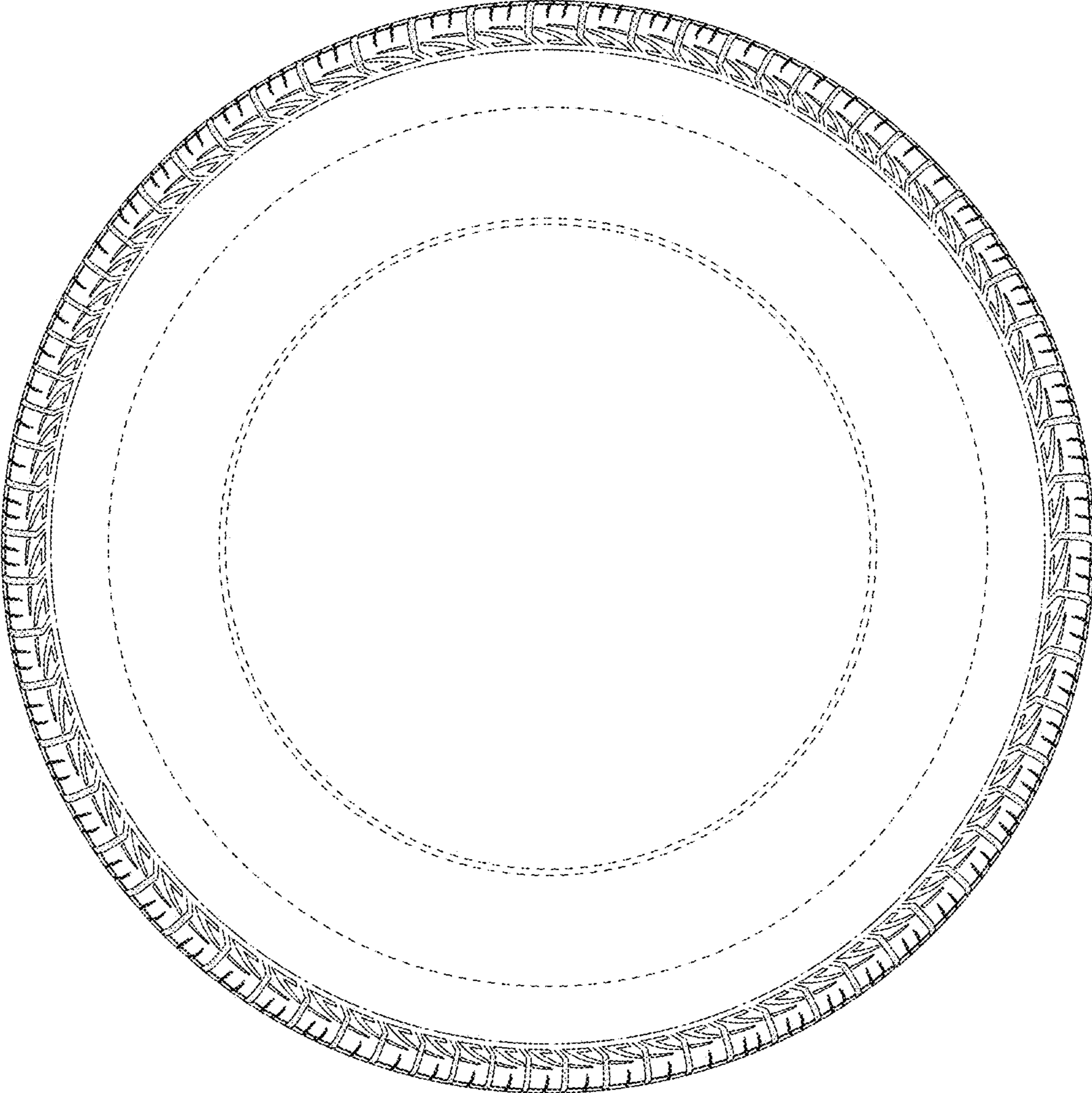

FIG. 5

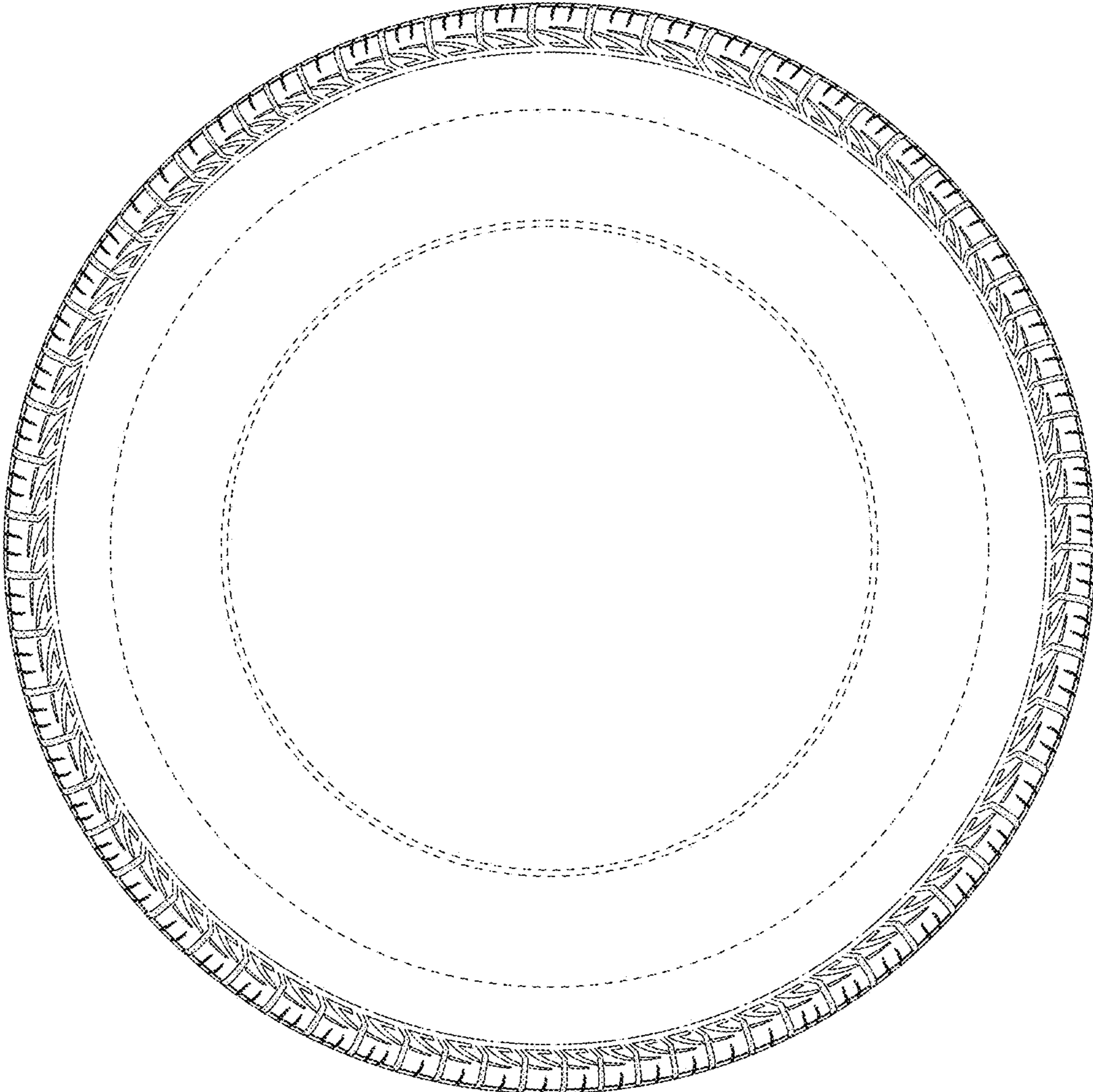

FIG. 6

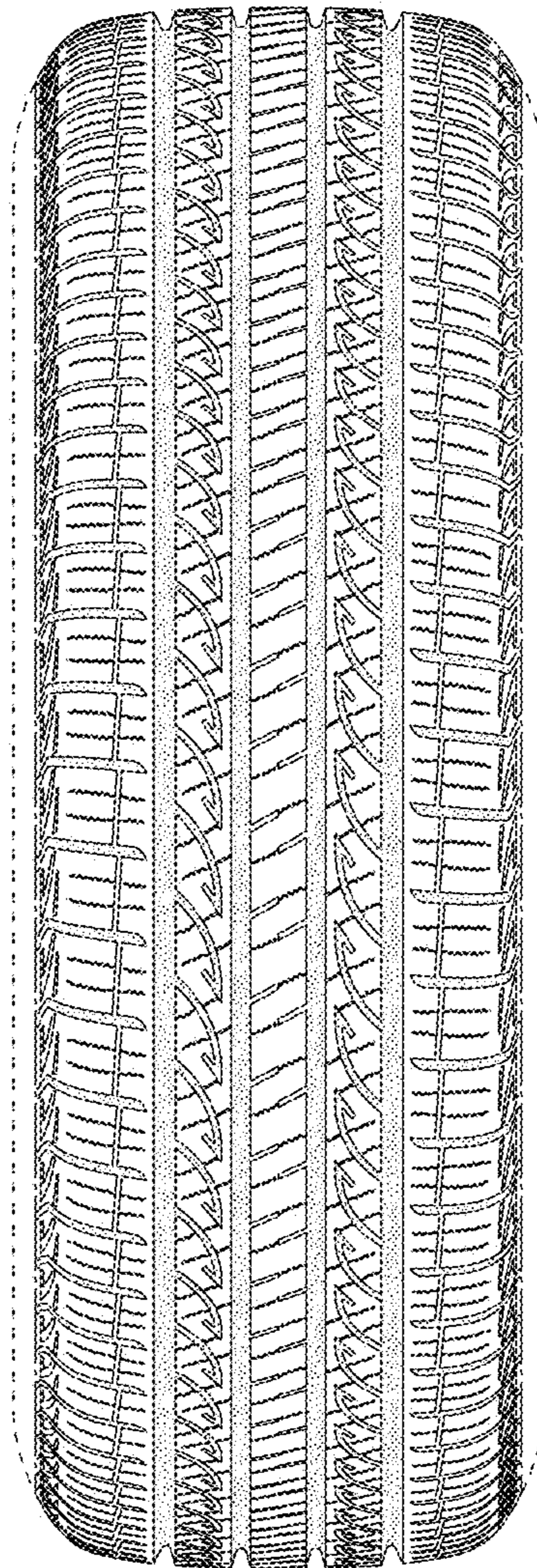

FIG. 7

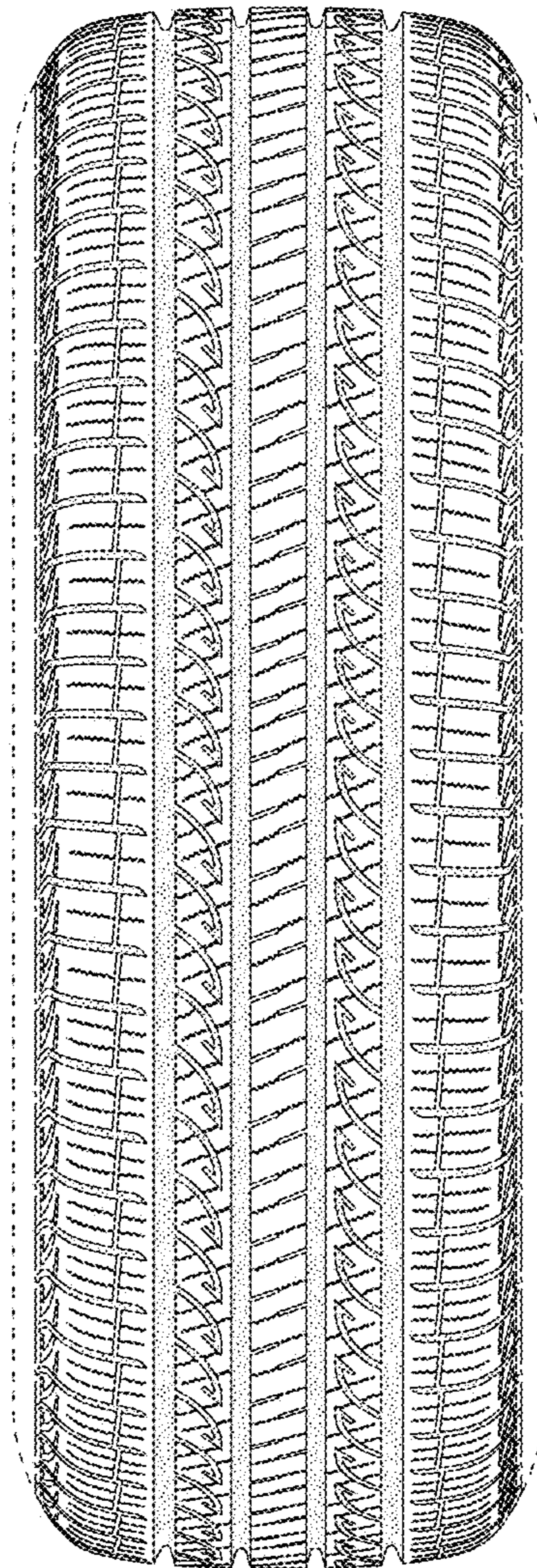

FIG. 8

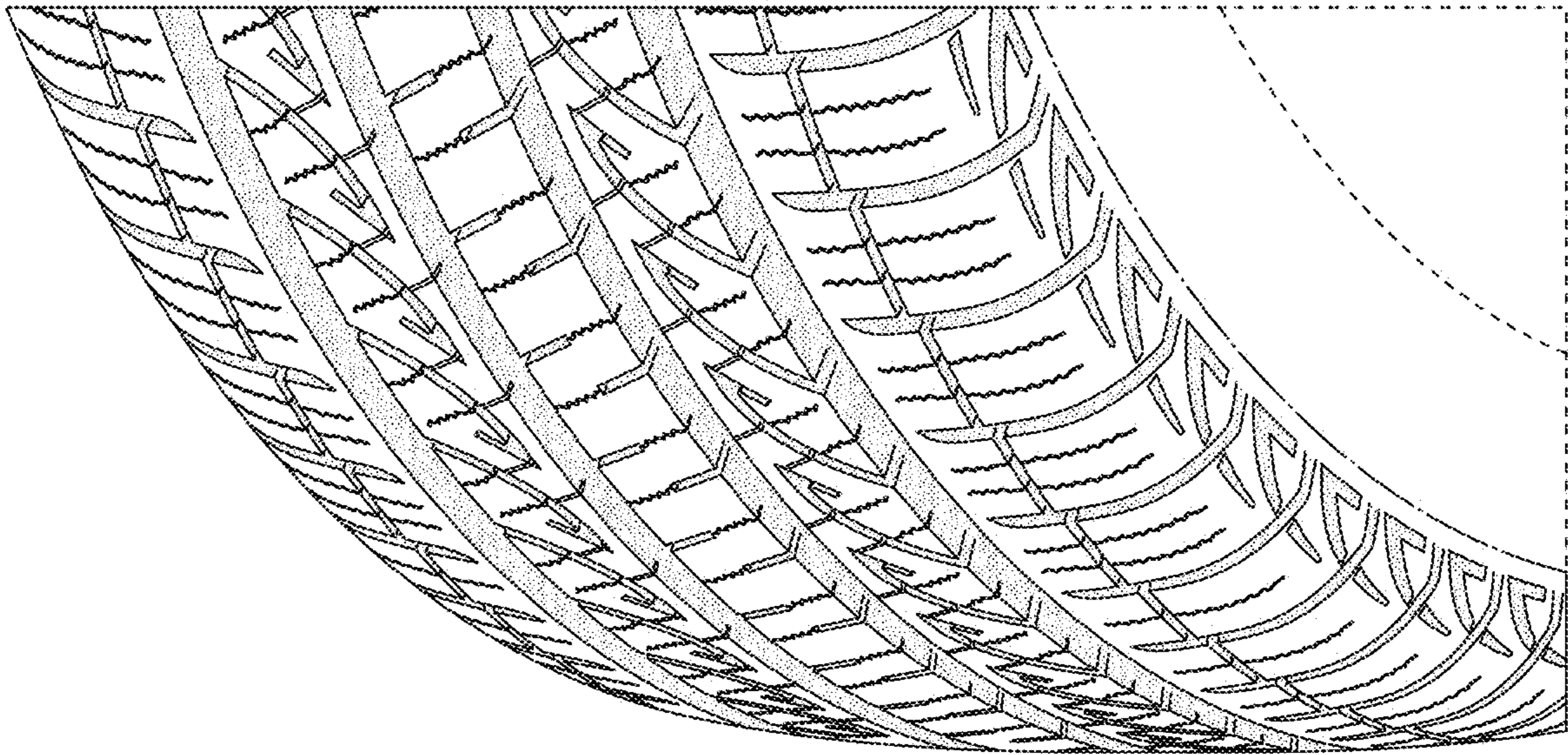

FIG. 9

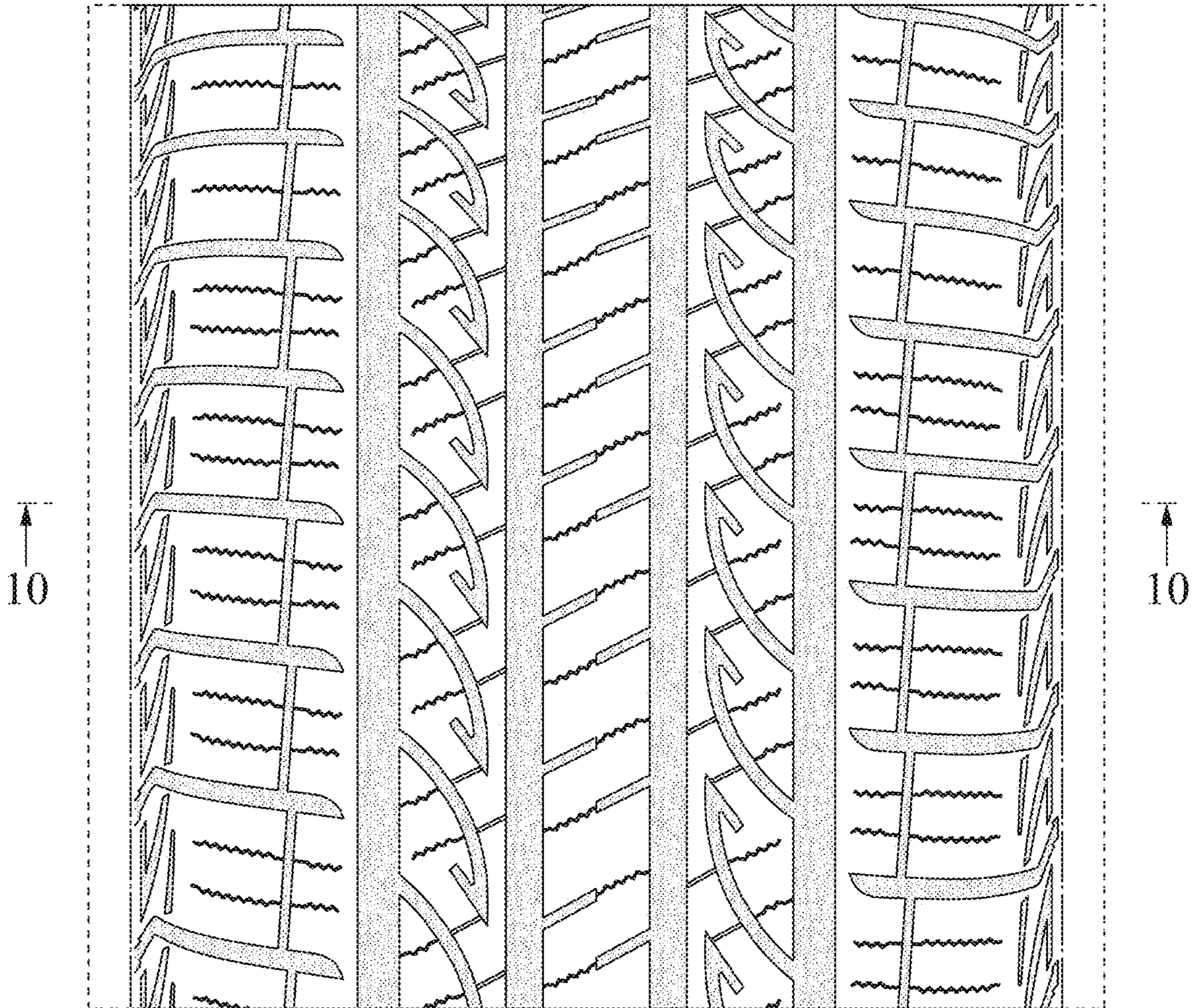

FIG. 10

