



US00D875554S

(12) **United States Design Patent** (10) **Patent No.:** **US D875,554 S**
Bai (45) **Date of Patent:** **** Feb. 18, 2020**

(54) **ELECTRONIC CLOCK**

FOREIGN PATENT DOCUMENTS

(71) Applicant: **Shenzhen Yuanguanghao Electronics Co., Ltd.**, Shenzhen (CN)

CN 201530323942 * 8/2015
EM 004555530-0002 * 12/2017

(72) Inventor: **Huijian Bai**, Shenzhen (CN)

OTHER PUBLICATIONS

(**) Term: **15 Years**

Youtube, Haptime Digital Alarm Clock, posted Aug. 19, 2018, [online], [visited Nov. 21, 2019]. Internet, <URL: <https://www.youtube.com/watch?v=quSEgzmlAAQ>> (Year: 2018).*

(21) Appl. No.: **29/665,803**

* cited by examiner

(22) Filed: **Oct. 7, 2018**

(51) **LOC (12) Cl.** **10-01**

Primary Examiner — Sheryl Lane

(52) **U.S. Cl.**

Assistant Examiner — Samantha N Wood

USPC **D10/15**; D14/171

(74) *Attorney, Agent, or Firm* — Erson IP (Nelson IP)

(58) **Field of Classification Search**

(57) **CLAIM**

USPC D10/1, 2, 5, 6, 7, 14, 15, 18, 17, 20, 21, D10/22, 24, 48; D26/54, 51; D14/137, D14/155, 188, 189, 265, 171

The ornamental design for an electronic clock, as shown and described.

CPC .. G04G 5/00; G04G 5/02; G04G 5/04; G04G 9/00; G04G 9/0005; G04G 9/0017; G04G 9/0023; G04G 13/00; G04G 13/02; G04G 13/021; G04G 13/023; G04G 13/028

DESCRIPTION

See application file for complete search history.

FIG. 1 is a perspective view of an electronic clock showing my new design;
FIG. 2 is another perspective view thereof;
FIG. 3 is a front view thereof;
FIG. 4 is a rear view thereof;
FIG. 5 is a left side view thereof;
FIG. 6 is a right side view thereof;
FIG. 7 is a top plan view thereof; and,
FIG. 8 is a bottom plan view thereof.

(56) **References Cited**

U.S. PATENT DOCUMENTS

The broken lines are for the purposes of illustrating portions of the electronic clock and form no part of the claimed design.

D236,189 S * 8/1975 Daher D10/15
D238,253 S * 12/1975 Suzuki D10/15
D244,261 S * 5/1977 Tamura D10/15
D249,651 S * 9/1978 Hirosawa D10/15
D368,227 S * 3/1996 Danko D10/2
D485,190 S * 1/2004 Blaylock D10/15

1 Claim, 8 Drawing Sheets

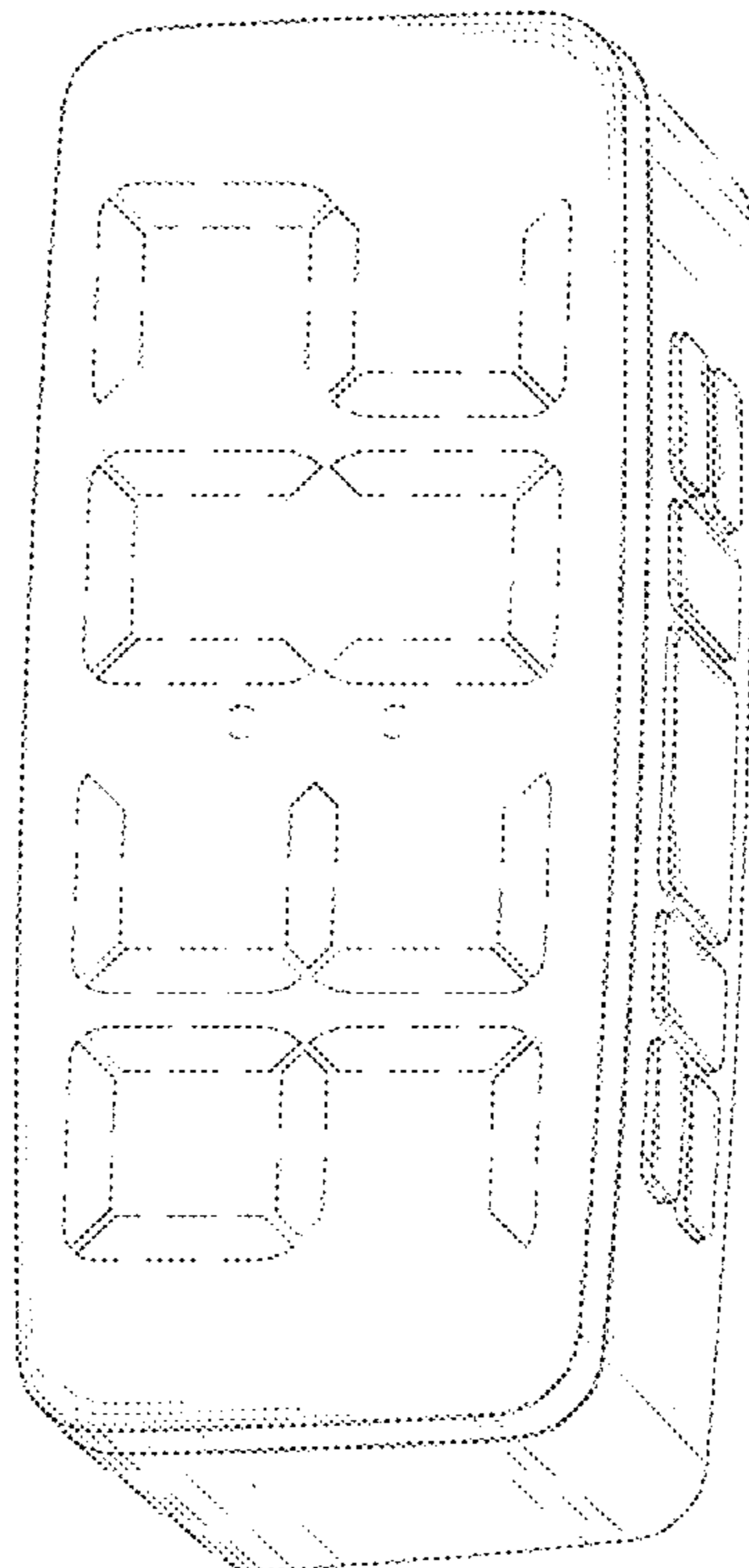

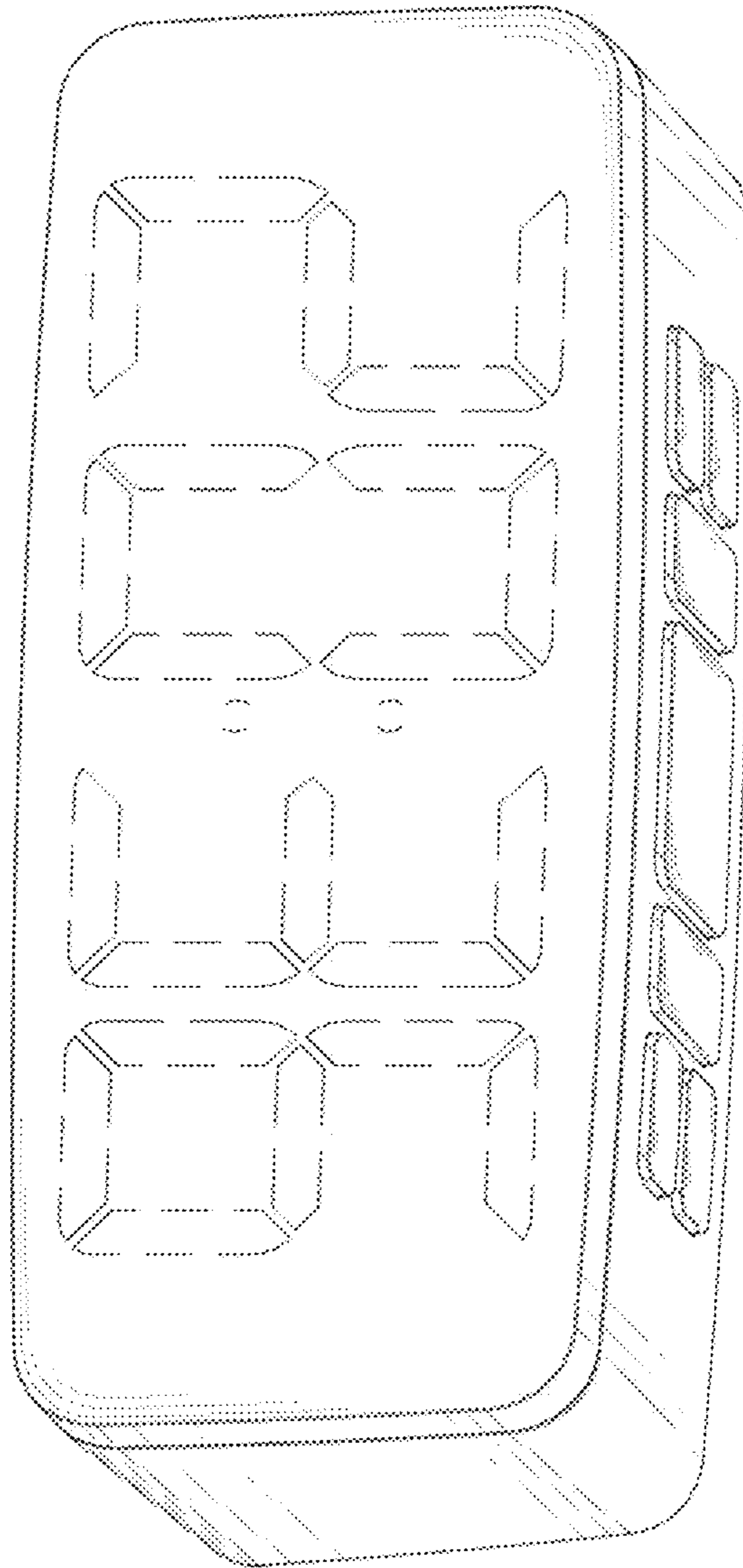

Fig. 1

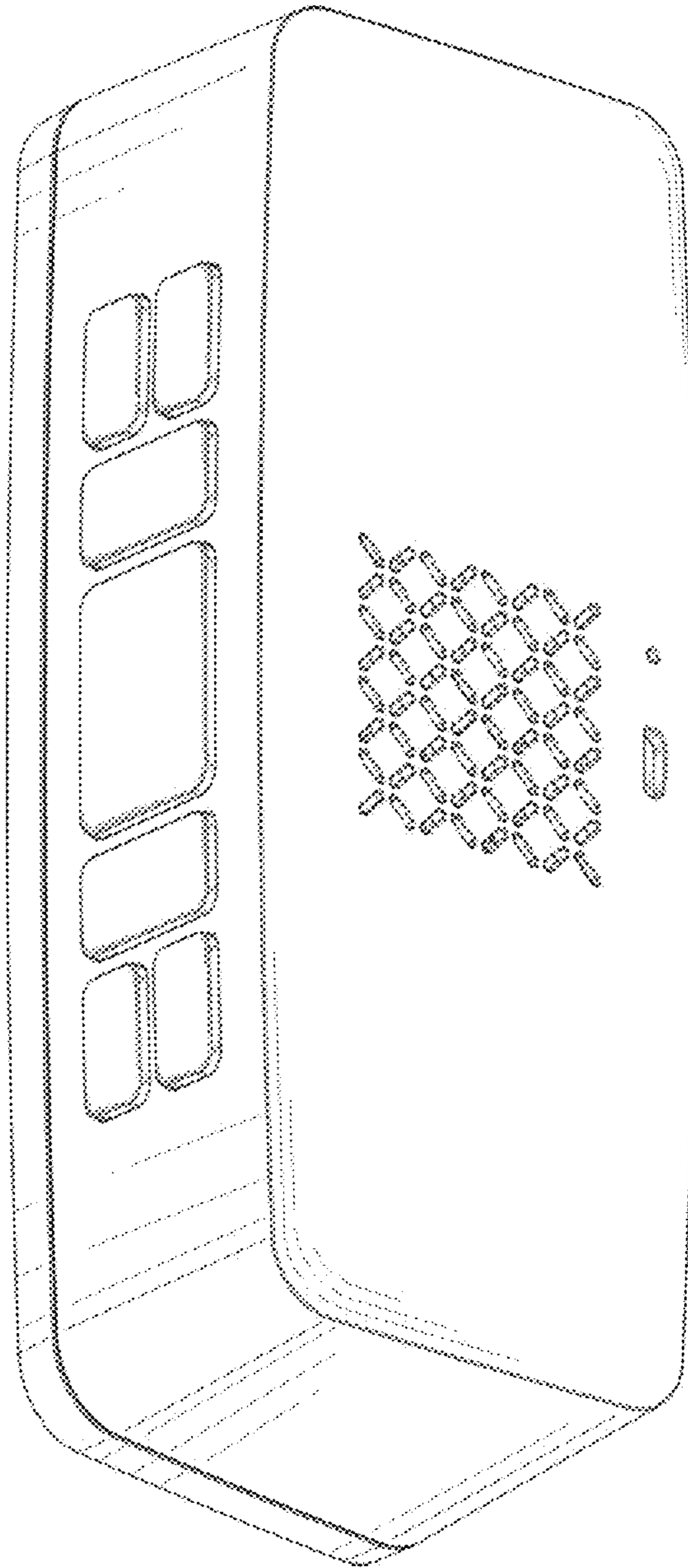

Fig. 2

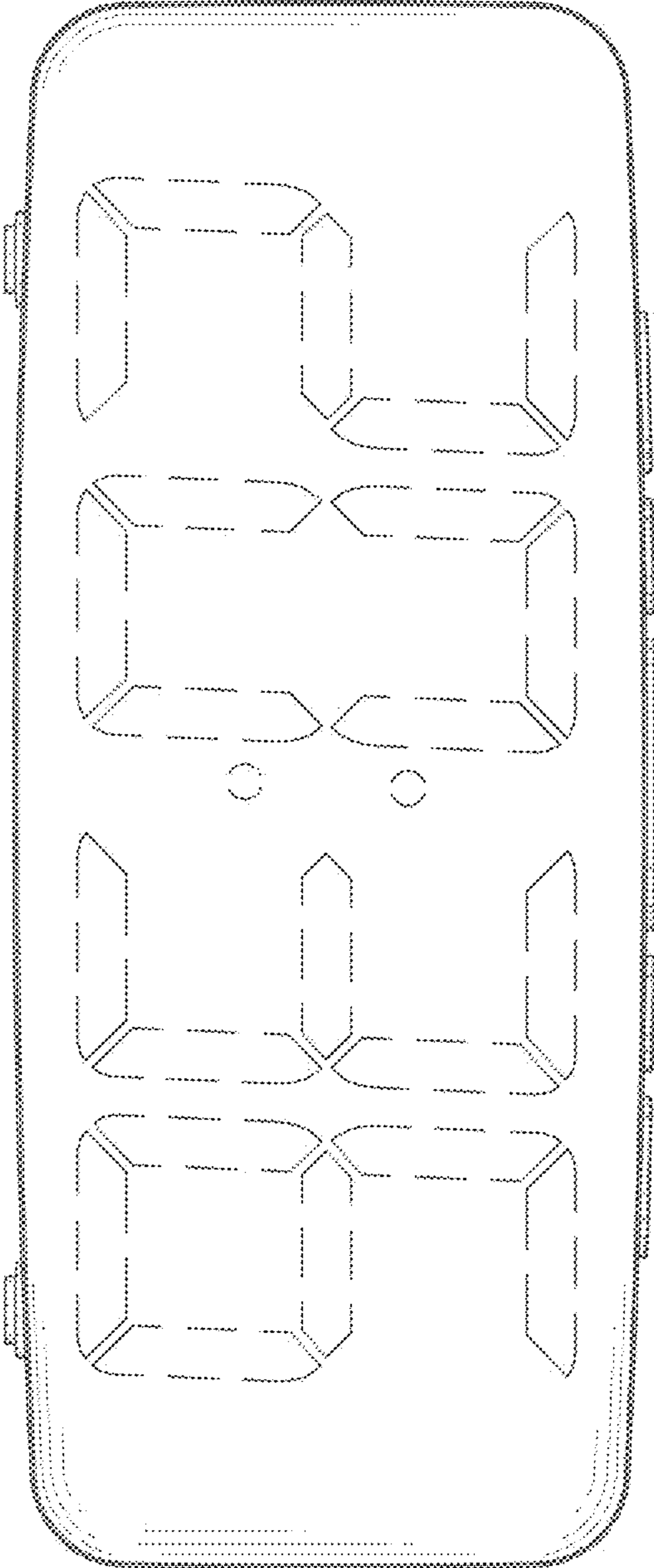

Fig. 3

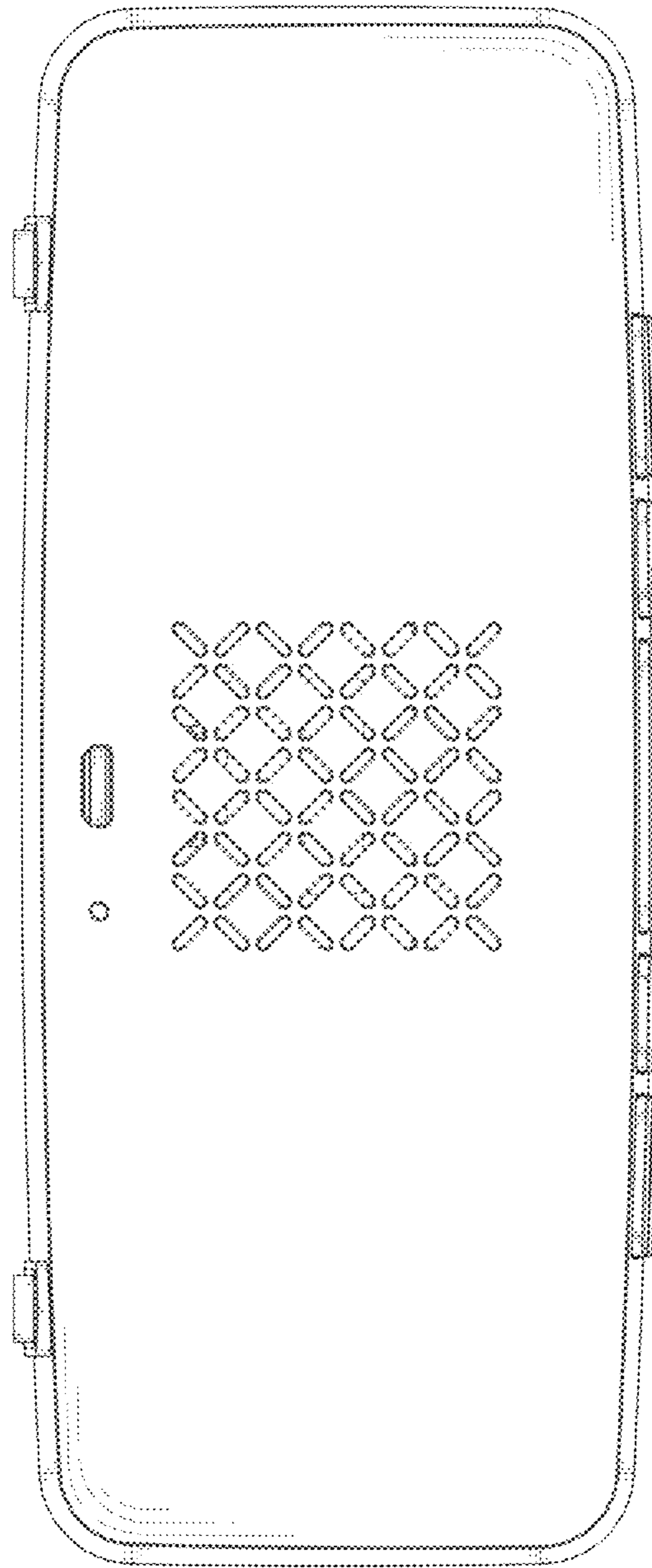

Fig. 4

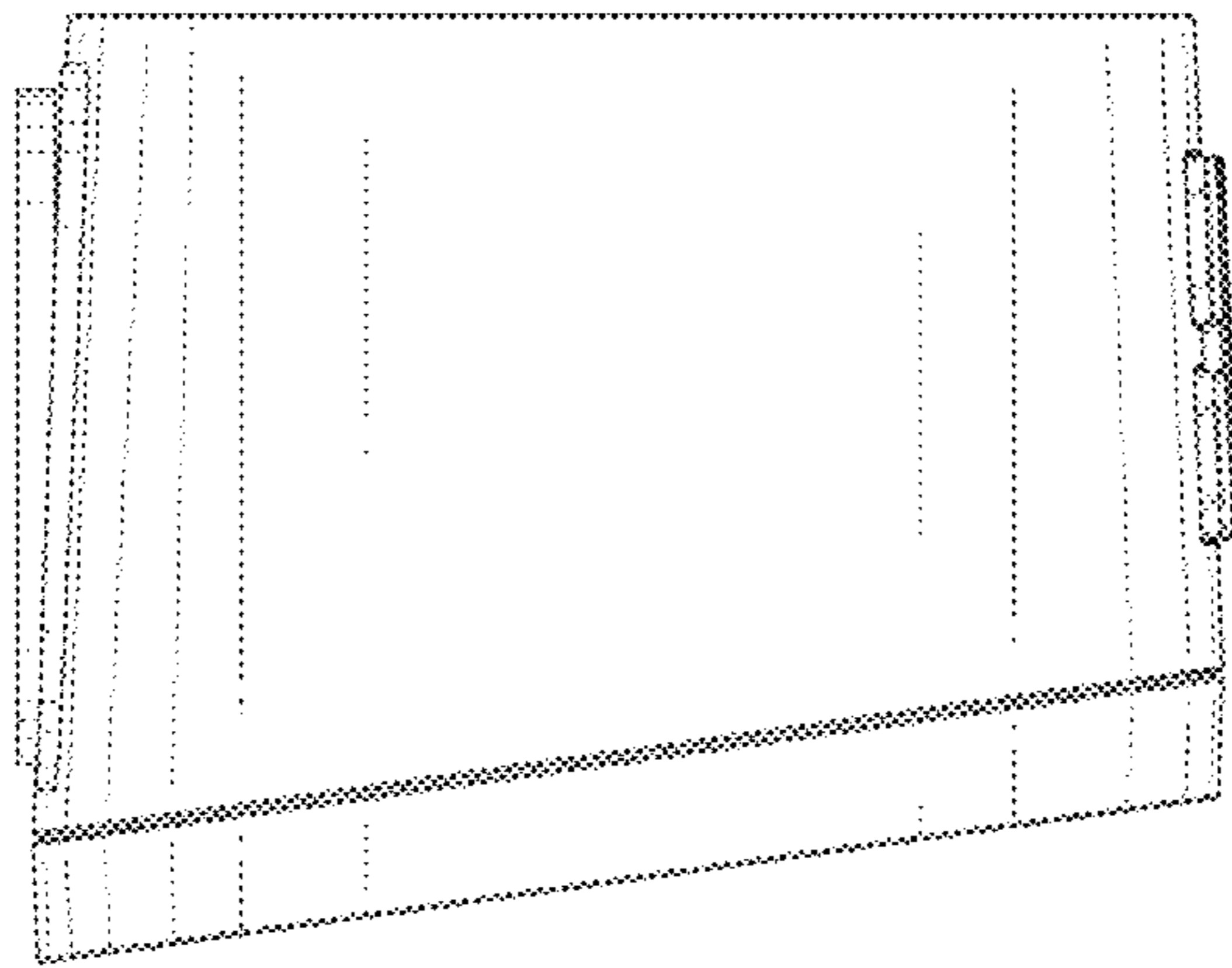

Fig. 5

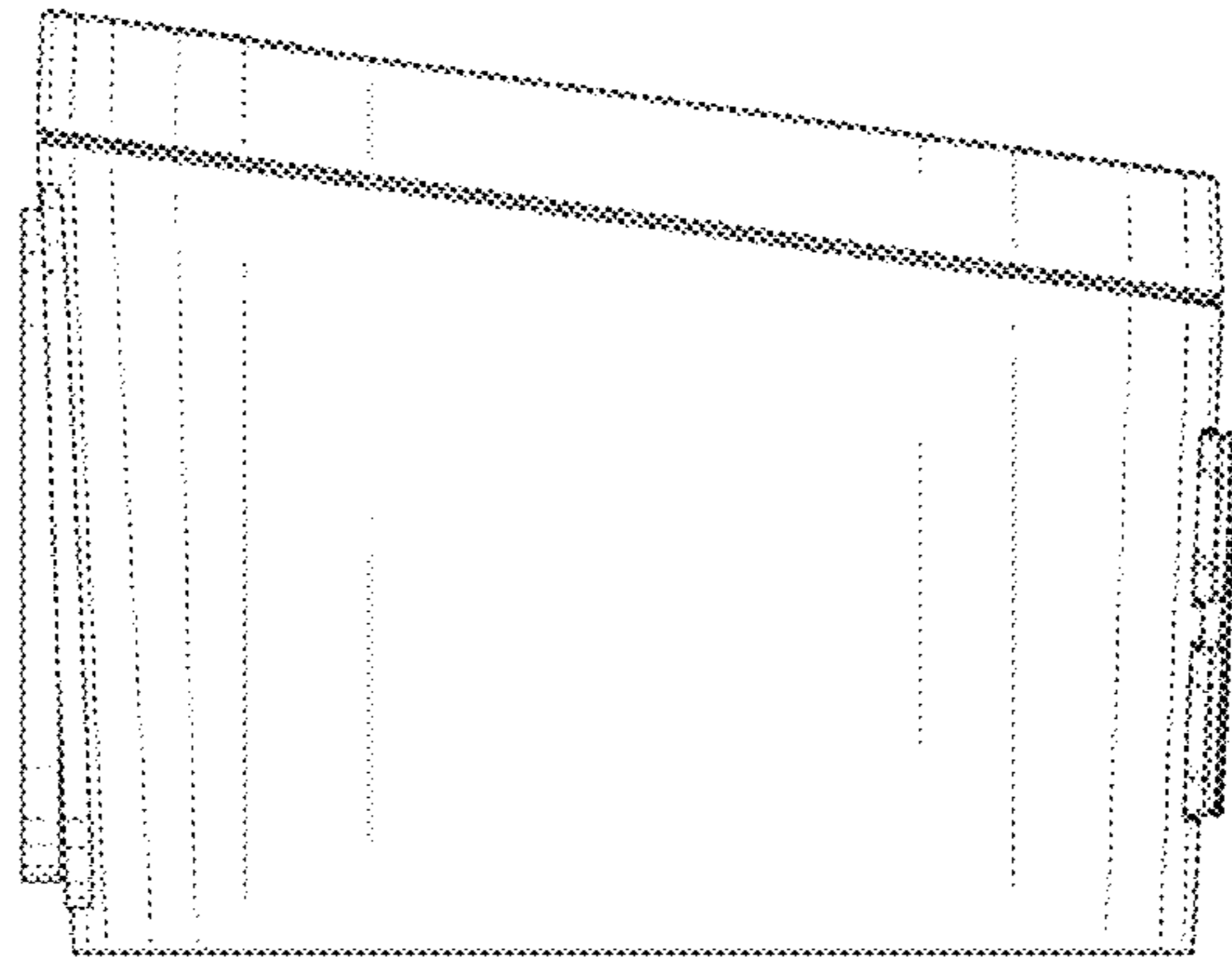

Fig. 6

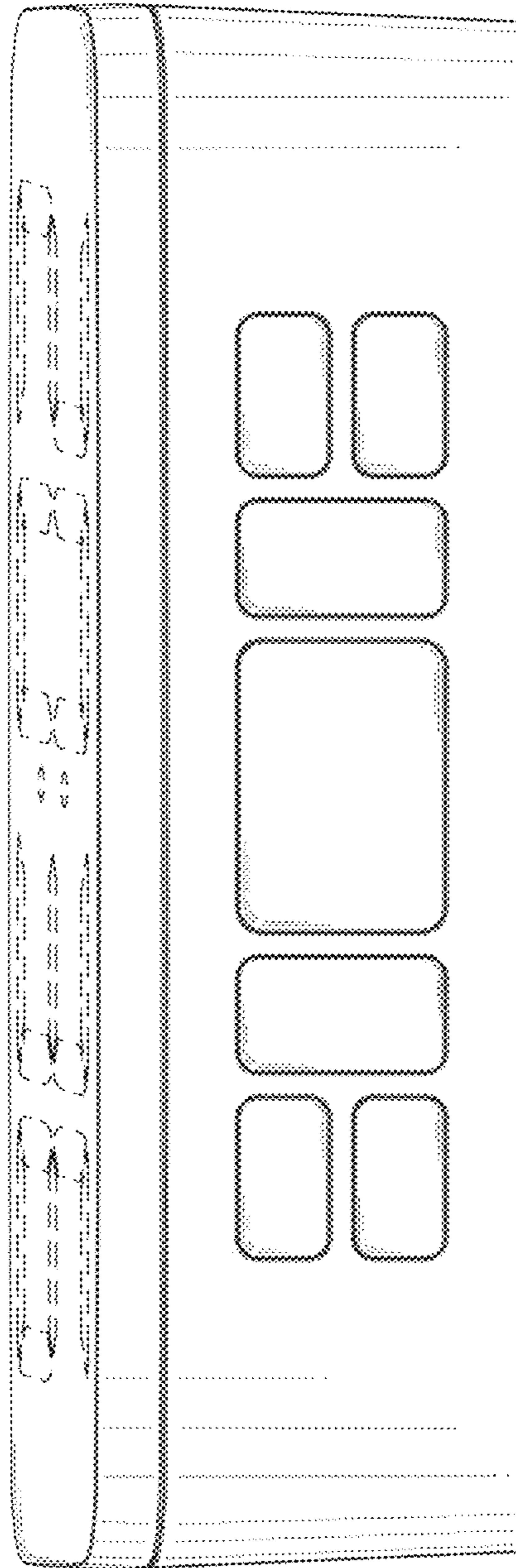

Fig. 7

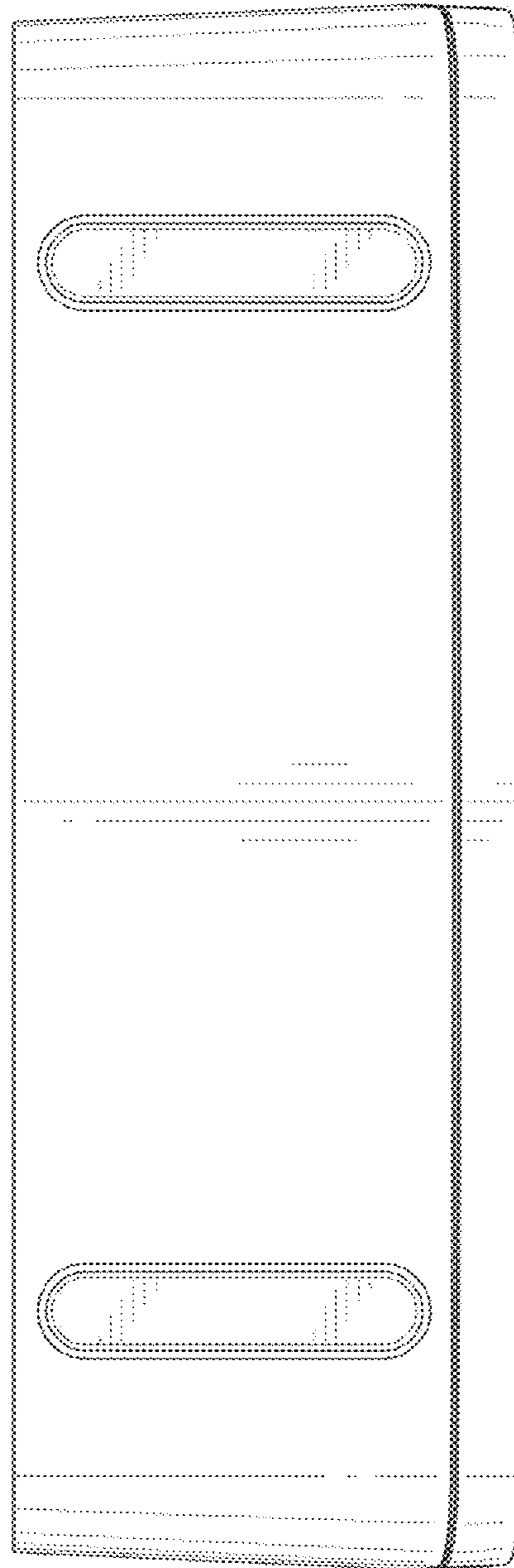

Fig. 8