



US00D875521S

(12) **United States Design Patent**
Elman

(10) **Patent No.:** **US D875,521 S**

(45) **Date of Patent:** **** Feb. 18, 2020**

(54) **FOLD-UP CONTAINER/DISPENSER WITH A FLOOR AND A DISPERSION PLATFORM**

(74) *Attorney, Agent, or Firm* — Quickpatents, LLC; Kevin Prince

(71) Applicant: **Noel Elman**, Brookline, MA (US)

(57) **CLAIM**

(72) Inventor: **Noel Elman**, Brookline, MA (US)

I claim the ornamental design for a fold-up container/dispenser with a floor and a dispersion platform, as shown and described.

(**) Term: **15 Years**

(21) Appl. No.: **29/695,088**

(22) Filed: **Jun. 14, 2019**

DESCRIPTION

Related U.S. Application Data

(62) Division of application No. 29/633,676, filed on Jan. 15, 2018, now Pat. No. Des. 857,495.

(51) **LOC (12) Cl.** **09-03**

(52) **U.S. Cl.**
USPC **D9/430; D9/420**

(58) **Field of Classification Search**
USPC D9/414–423, 424–429, 430–433, 434, D9/456, 457, 711, 713, 721–722, 737; D3/272–274, 290, 304, 305, 315
(Continued)

FIG. 1 is a top perspective view of a fold-up container with a floor and a dispersion screen, showing a first embodiment of my new design in an assembled configuration with a lid in a closed configuration;
FIG. 2 is a top perspective view thereof, illustrated with the lid in an open configuration;
FIG. 3 is a top perspective view thereof, illustrated with the lid in an open configuration and the dispersion screen folded away from the container;
FIG. 4 is a front elevational view of FIG. 1;
FIG. 5 is a rear elevational view of FIG. 1;
FIG. 6 is a left-side elevational view of FIG. 1;
FIG. 7 is a right-side elevational view of FIG. 1;
FIG. 8 is a top plan view of FIG. 1;
FIG. 9 is a bottom plan view of FIG. 1;
FIG. 10 is a top plan view thereof, illustrated in a flat configuration;
FIG. 11 is a top perspective view of a second embodiment thereof in the assembled configuration with the lid in the closed configuration;
FIG. 12 is a top perspective view thereof, illustrated with the lid in the open configuration;
FIG. 13 is a top perspective view thereof, illustrated with the lid in the open configuration and the dispersion screen folded away from the container;
FIG. 14 is a front elevational view of FIG. 11;
FIG. 15 is a rear elevational view of FIG. 11;
FIG. 16 is a left-side elevational view of FIG. 11;
FIG. 17 is a right-side elevational view of FIG. 11;
FIG. 18 is a top plan view of FIG. 11;
FIG. 19 is a bottom plan view of FIG. 11; and,
FIG. 20 is a top plan view thereof, illustrated in the flat configuration.

(56) **References Cited**

U.S. PATENT DOCUMENTS

1,689,069 A * 10/1928 Carver B65D 5/02 229/120.1
2,112,879 A * 4/1938 Broderick B65D 5/02 206/110

(Continued)

OTHER PUBLICATIONS

Hexagonal Money Boxes. [online] Published on Apr. 26, 2018. Retrieved Sep. 30, 2019 from URL: <https://www.popupmailers.co.uk/hexagonal-manual-money-box.php>.*

Primary Examiner — Vy N Koenig

(Continued)

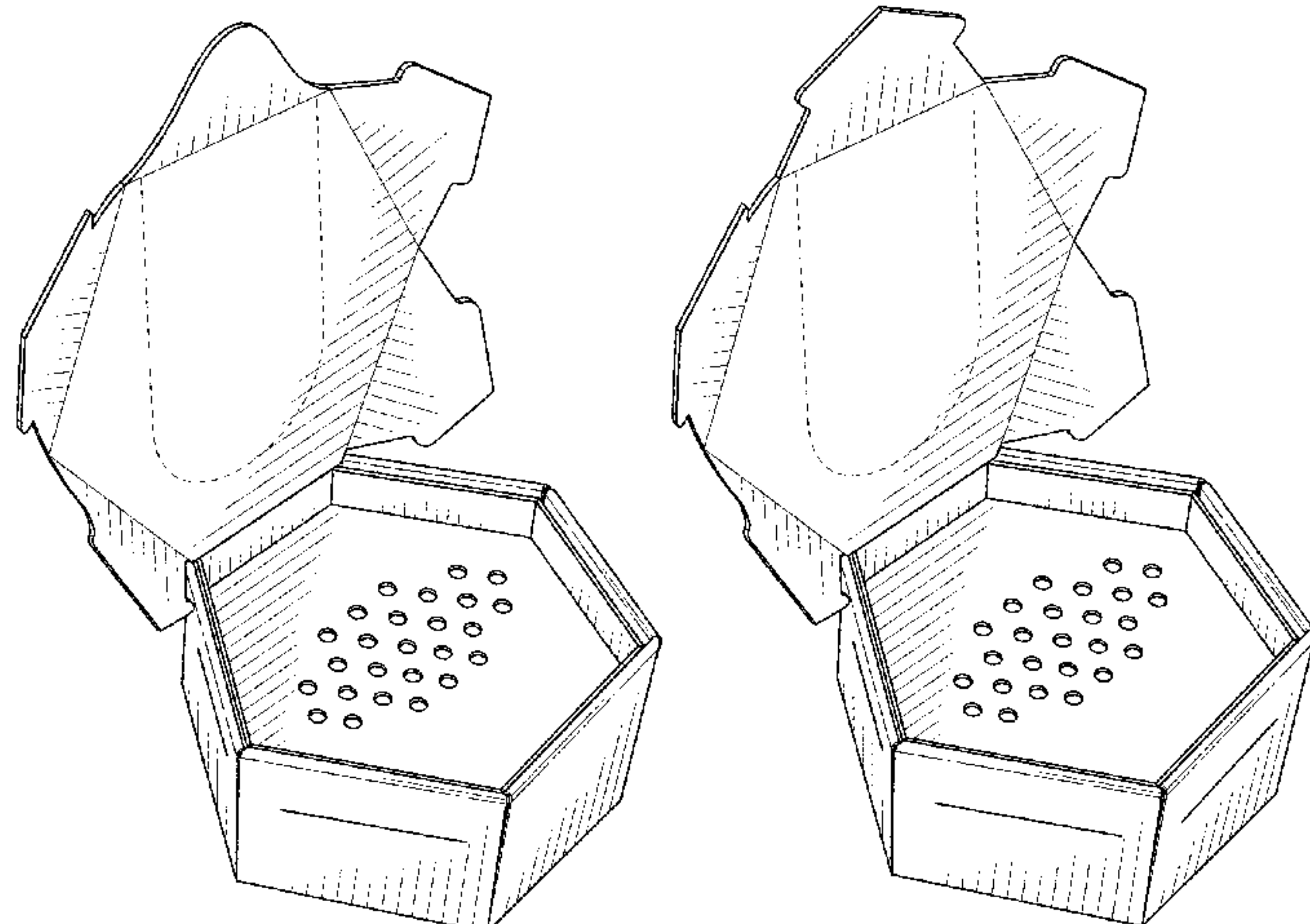

The broken lines in the figures depict portions of the fold-up container that form no part of the claimed design.

1 Claim, 12 Drawing Sheets

(58) Field of Classification Search

CPC ... B65D 5/00; B65D 5/02; B65D 5/18; B65D
5/20

See application file for complete search history.

(56) References Cited

U.S. PATENT DOCUMENTS

2,174,687	A *	10/1939	Comley	B65D 5/02 229/110
2,307,854	A *	1/1943	Palmer	B65D 5/64 229/122.31
2,320,665	A *	6/1943	Shearer	B65D 5/02 229/110
2,342,623	A *	2/1944	Aquino	B65D 5/02 229/110
D235,248	S *	6/1975	Bennett	D9/430
4,208,954	A *	6/1980	Chase	B65D 5/02 229/110
D257,829	S *	1/1981	Webinger	D9/430
5,971,263	A *	10/1999	Mangano	B65D 5/02 220/529
D672,645	S *	12/2012	Giannini	D9/430
D764,278	S *	8/2016	Tulin	D9/430
D764,909	S *	8/2016	Tulin	D9/430
D775,943	S *	1/2017	Quiroga De La Garza ..	D9/414
D857,495	S *	8/2019	Elman	D9/430

* cited by examiner

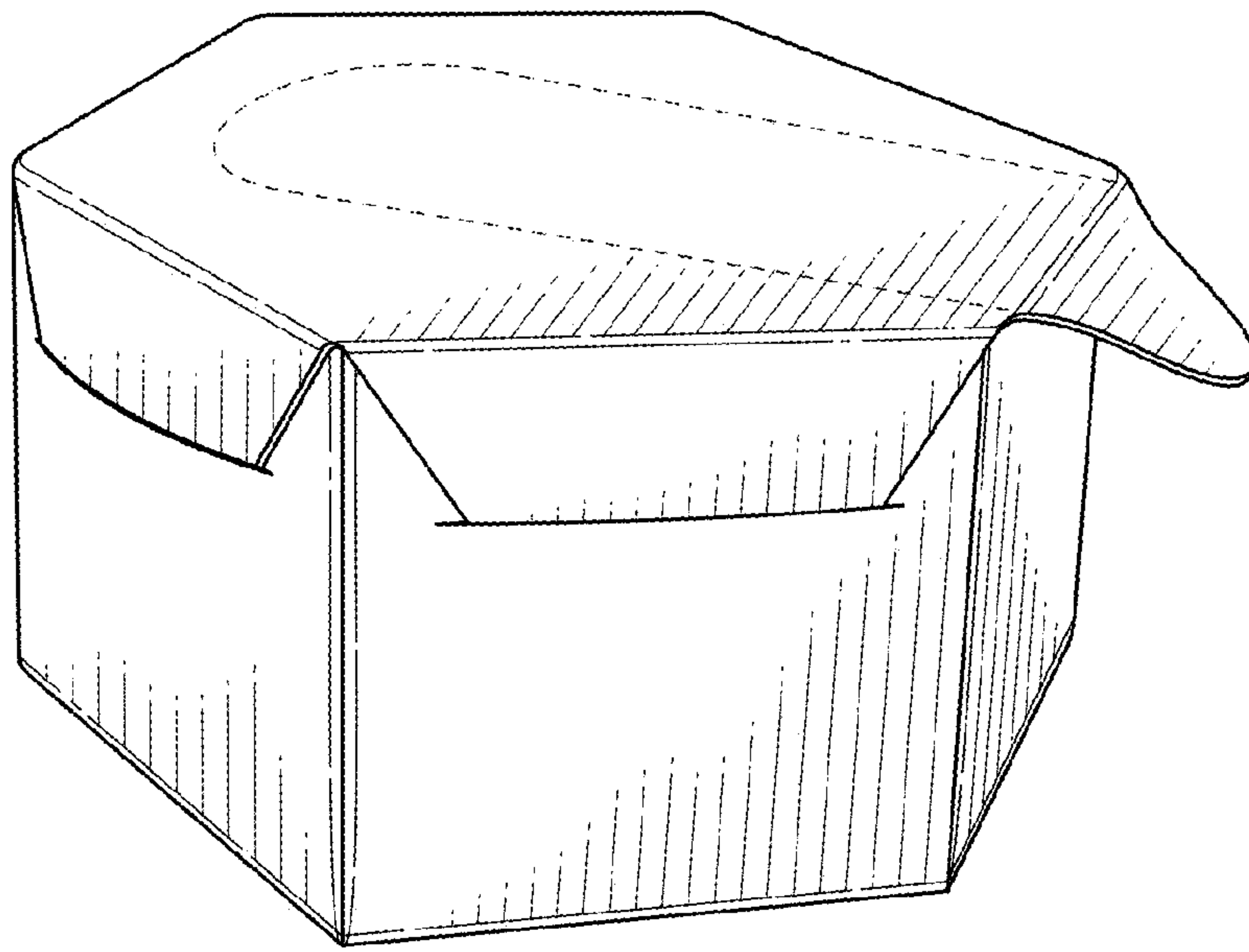

FIG. 1

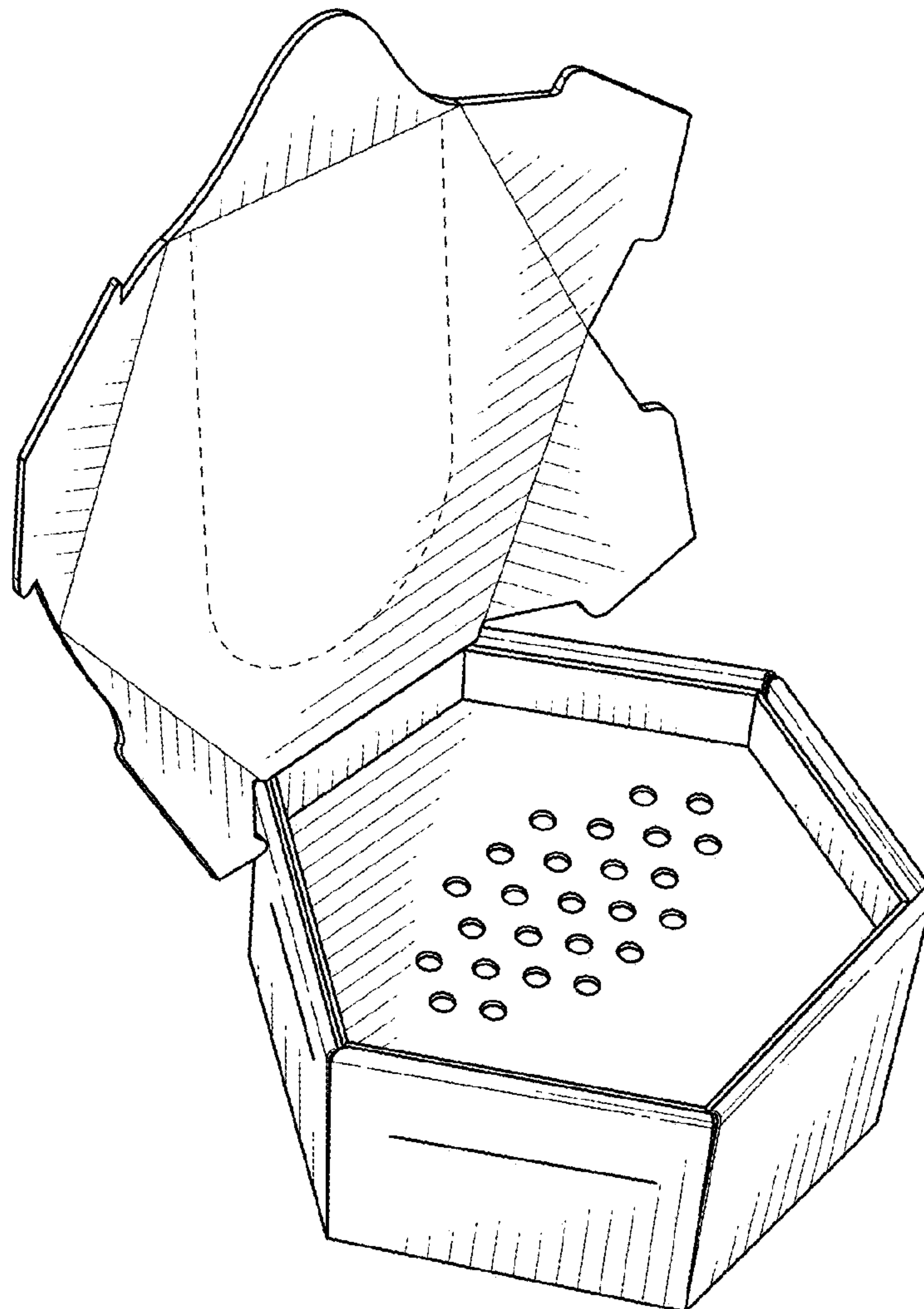

FIG. 2

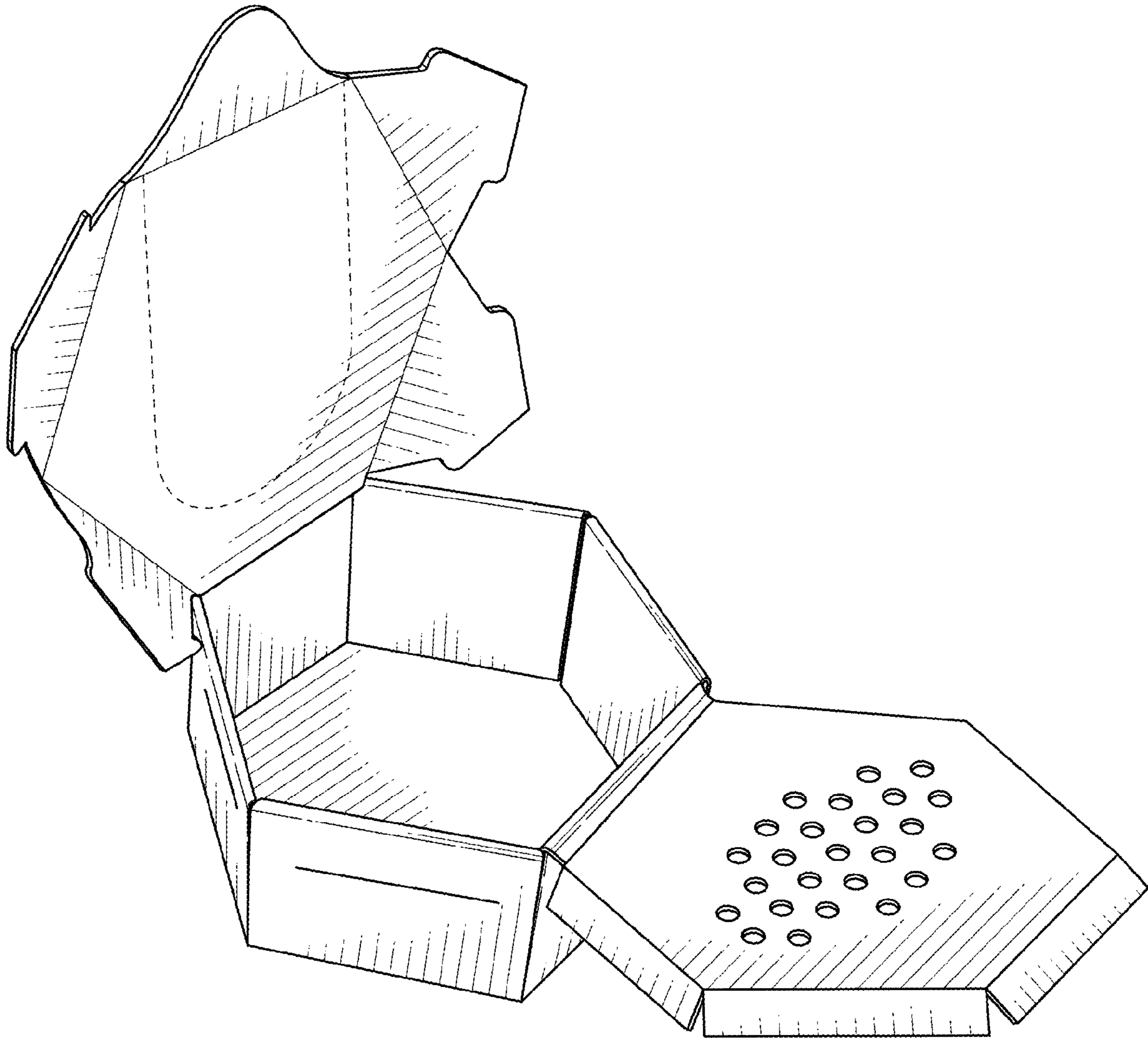

FIG. 3

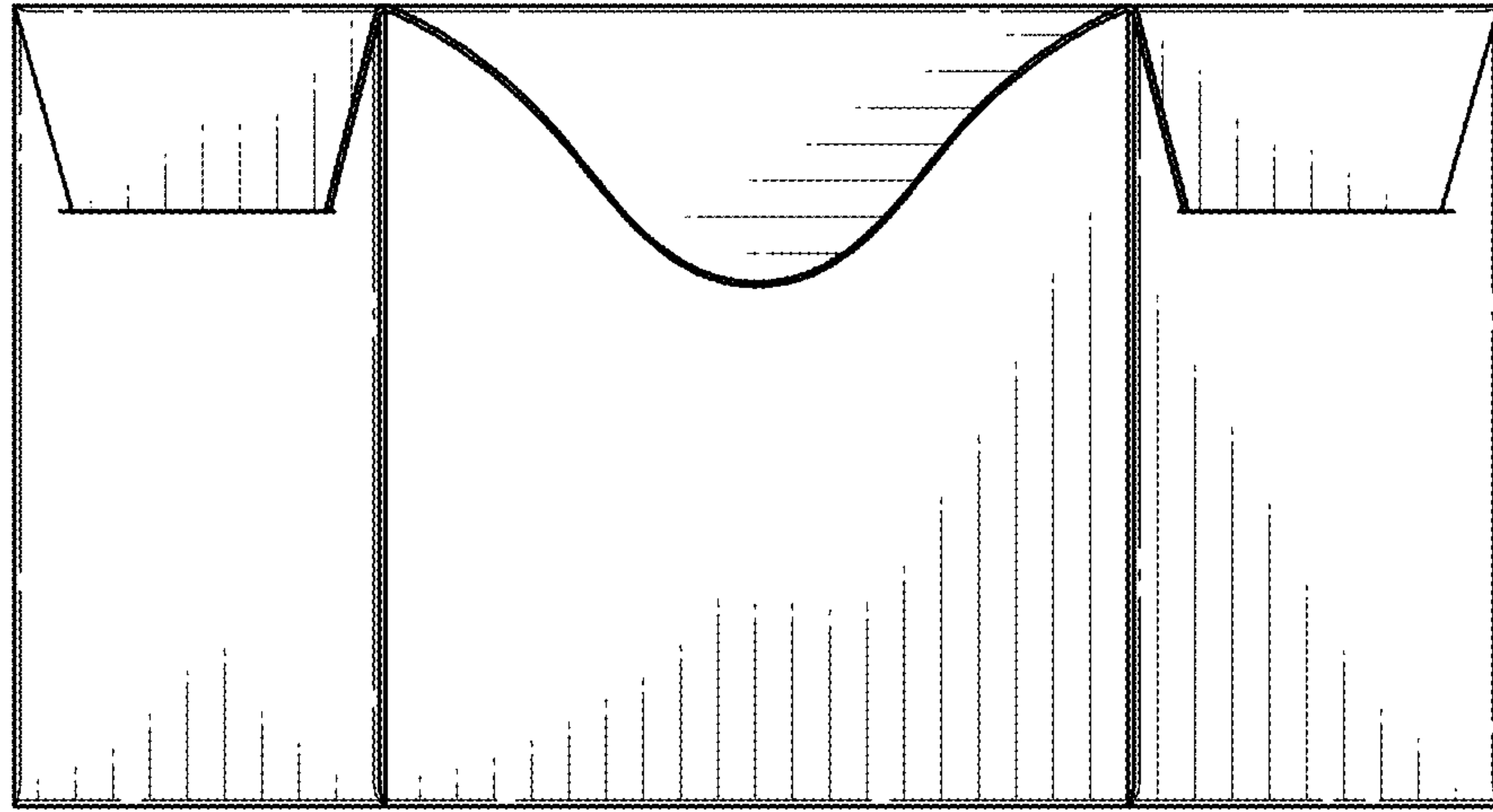

FIG. 4

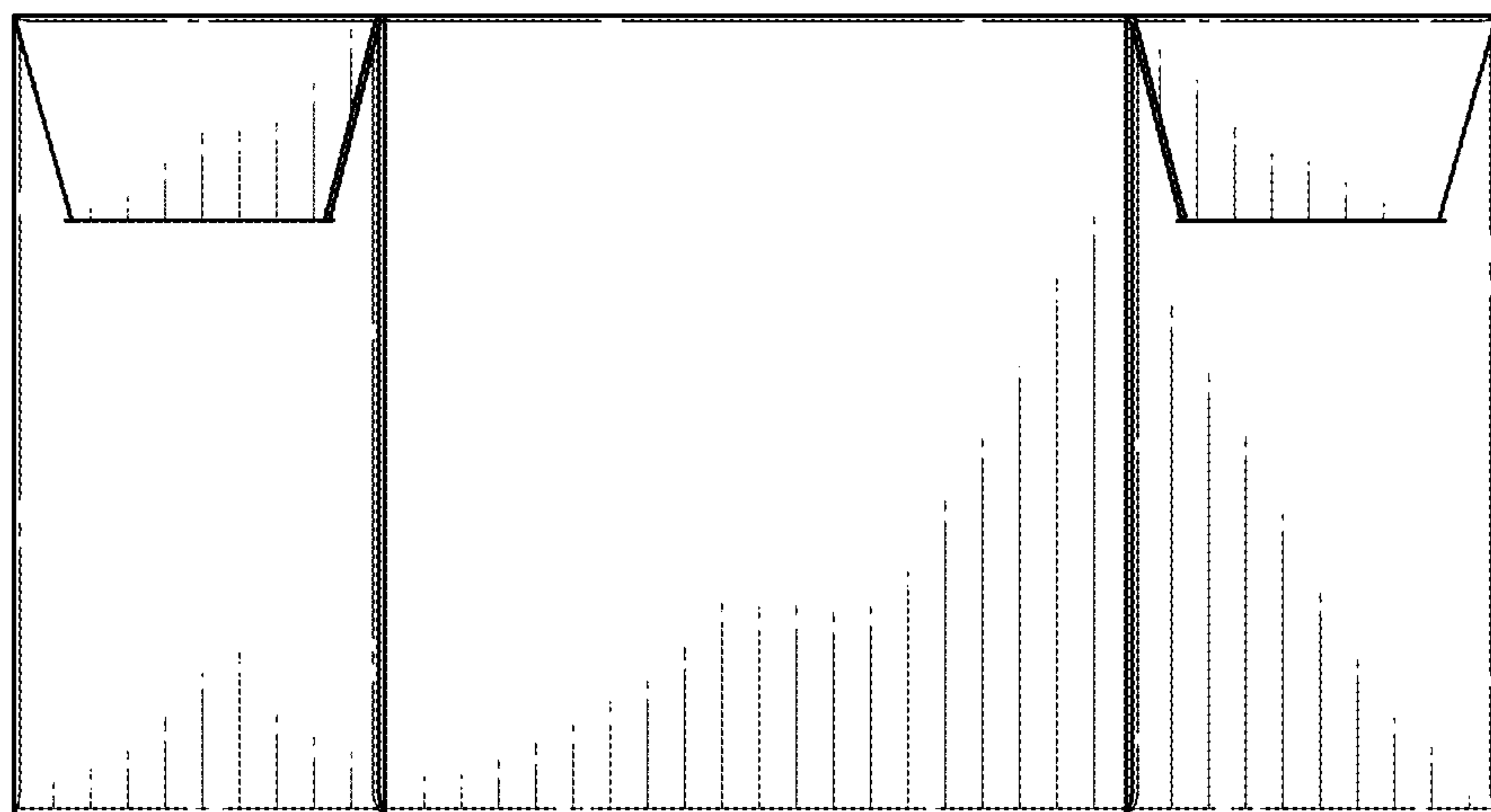

FIG. 5

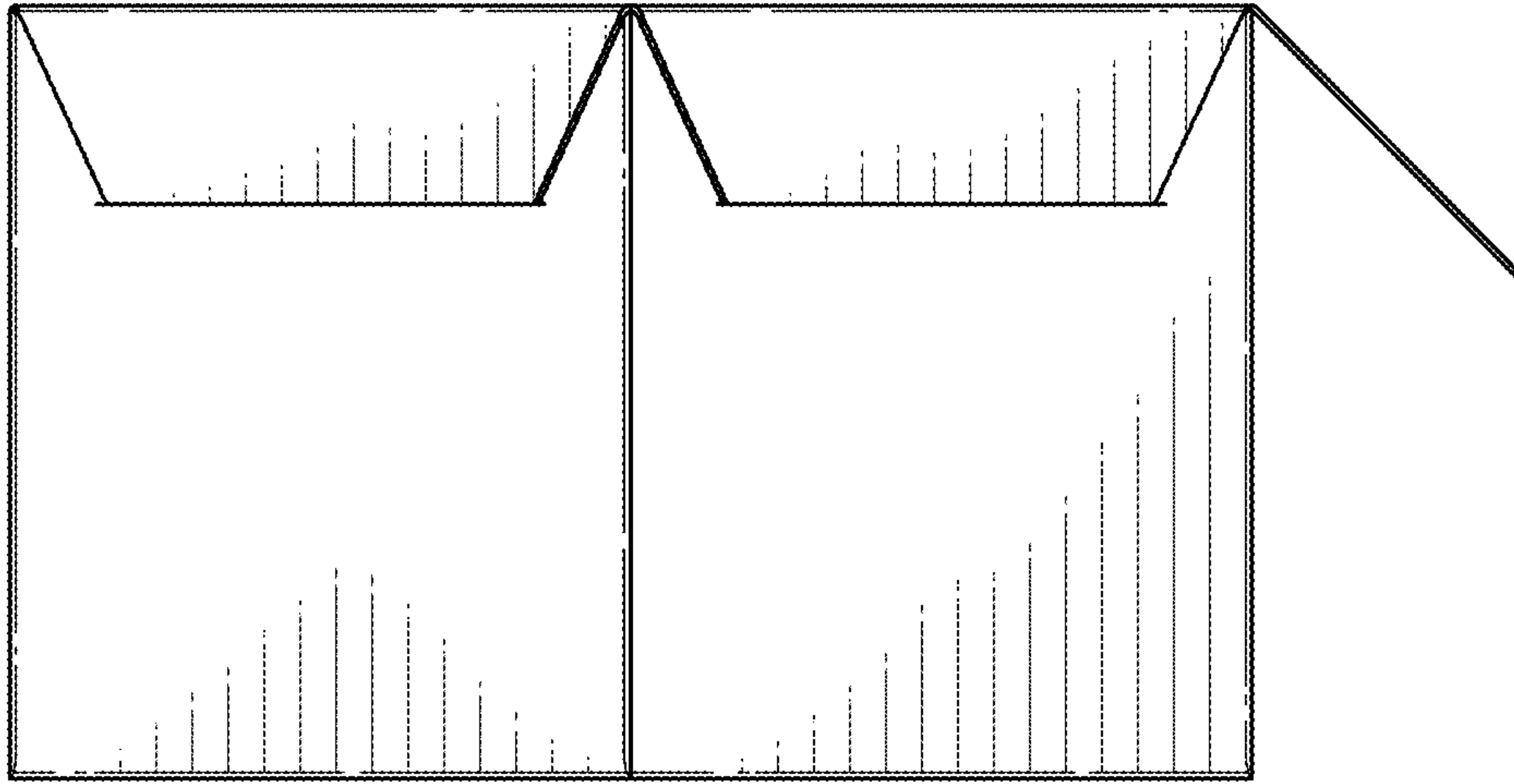

FIG. 6

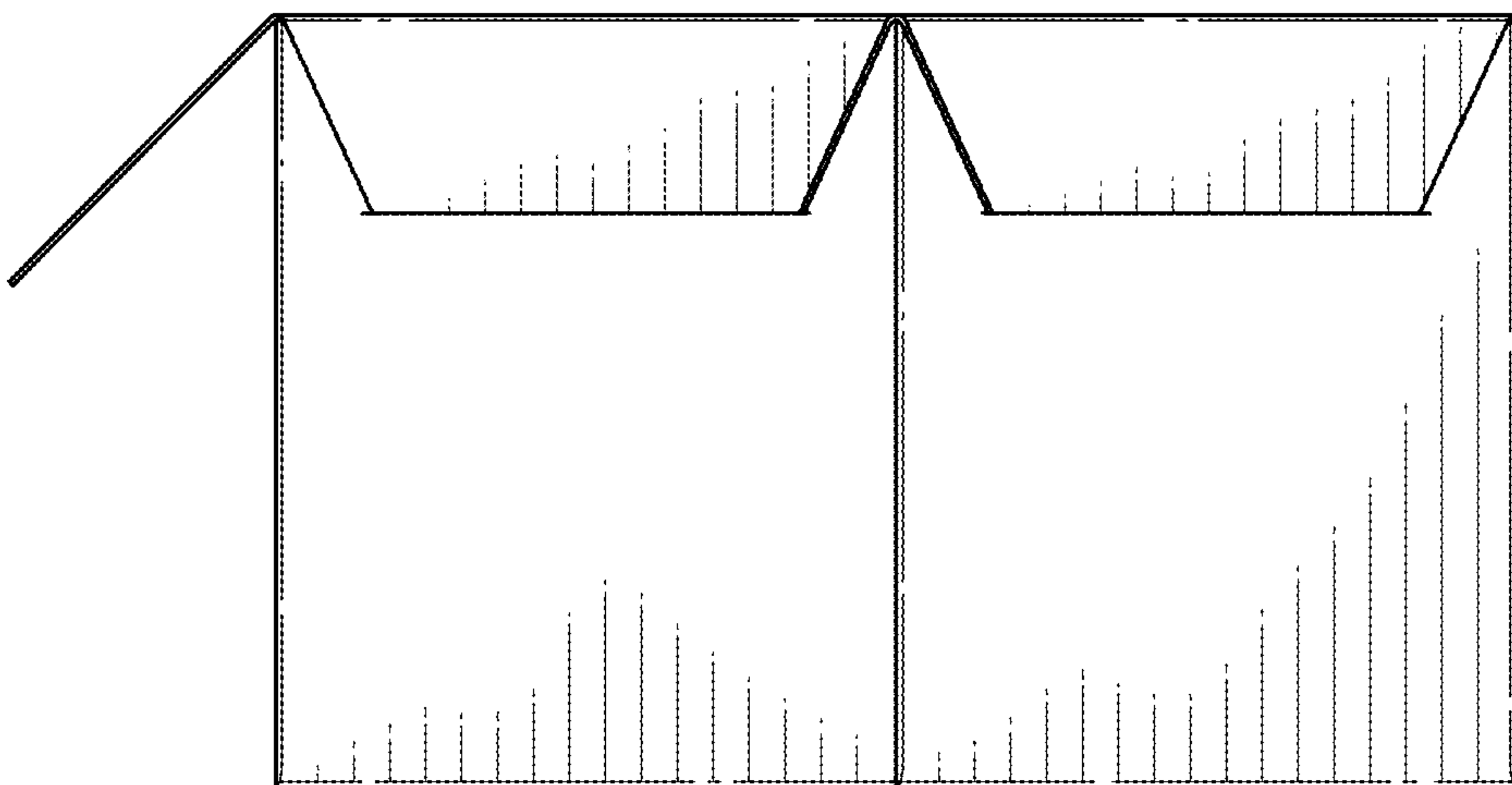

FIG. 7

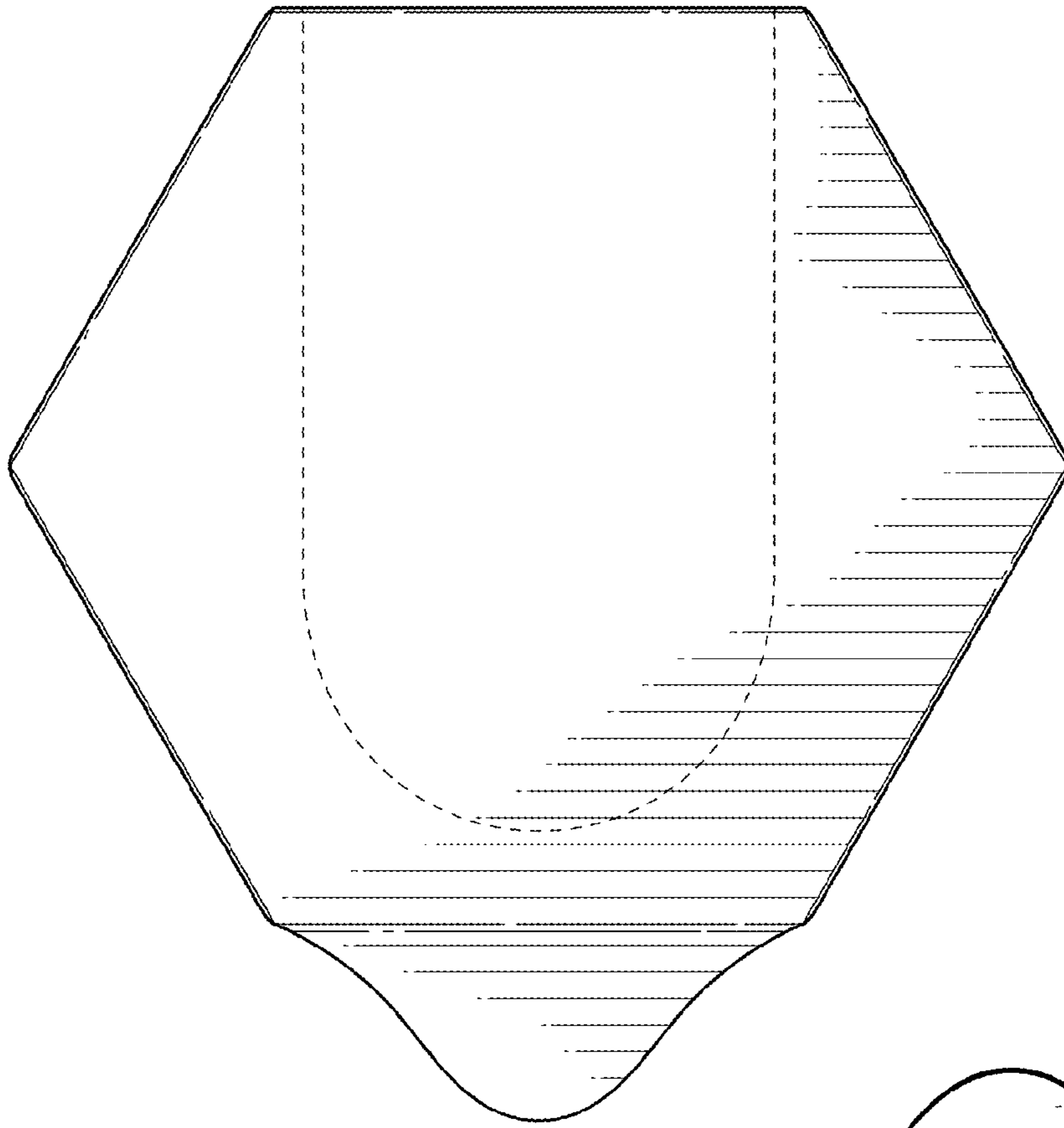

FIG. 8

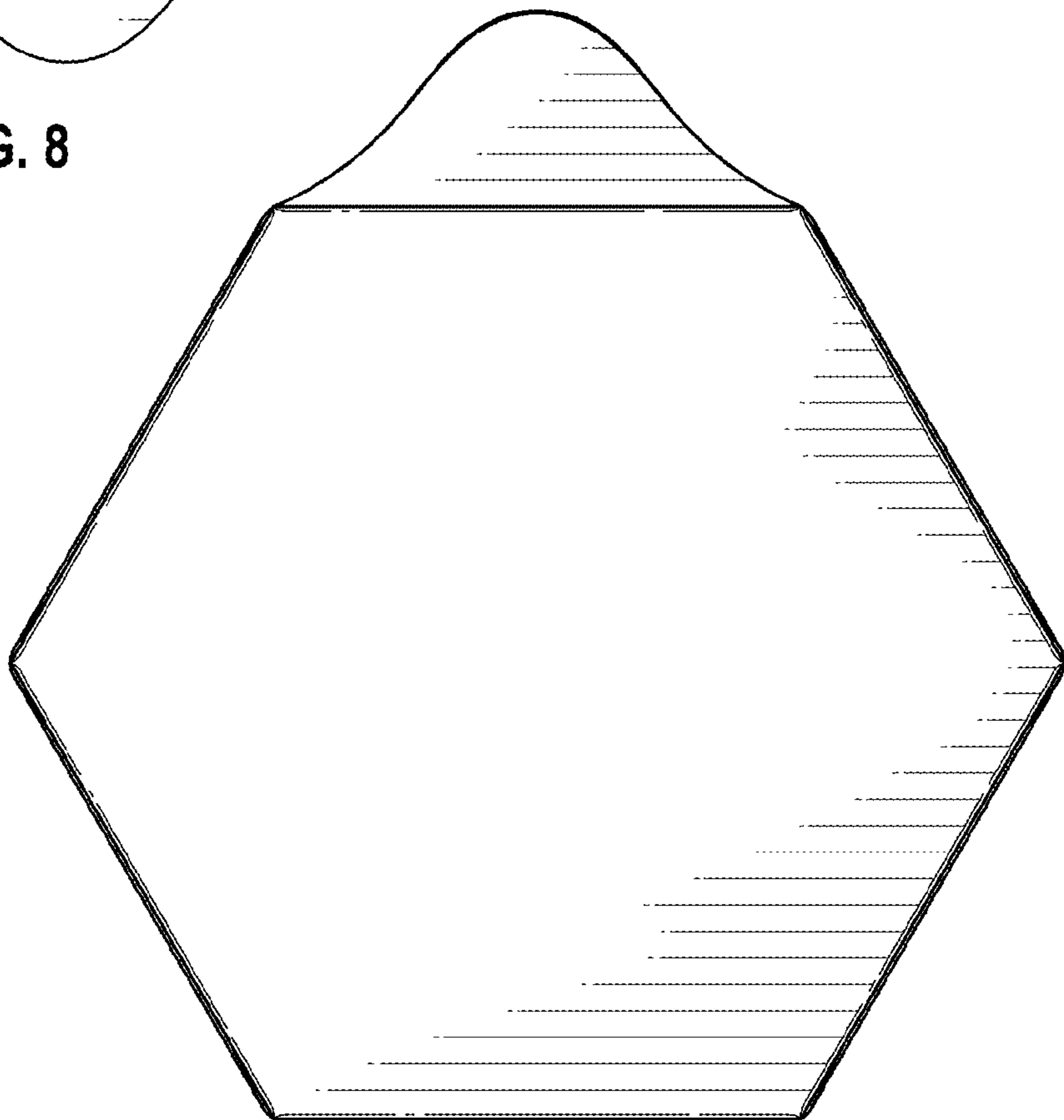

FIG. 9

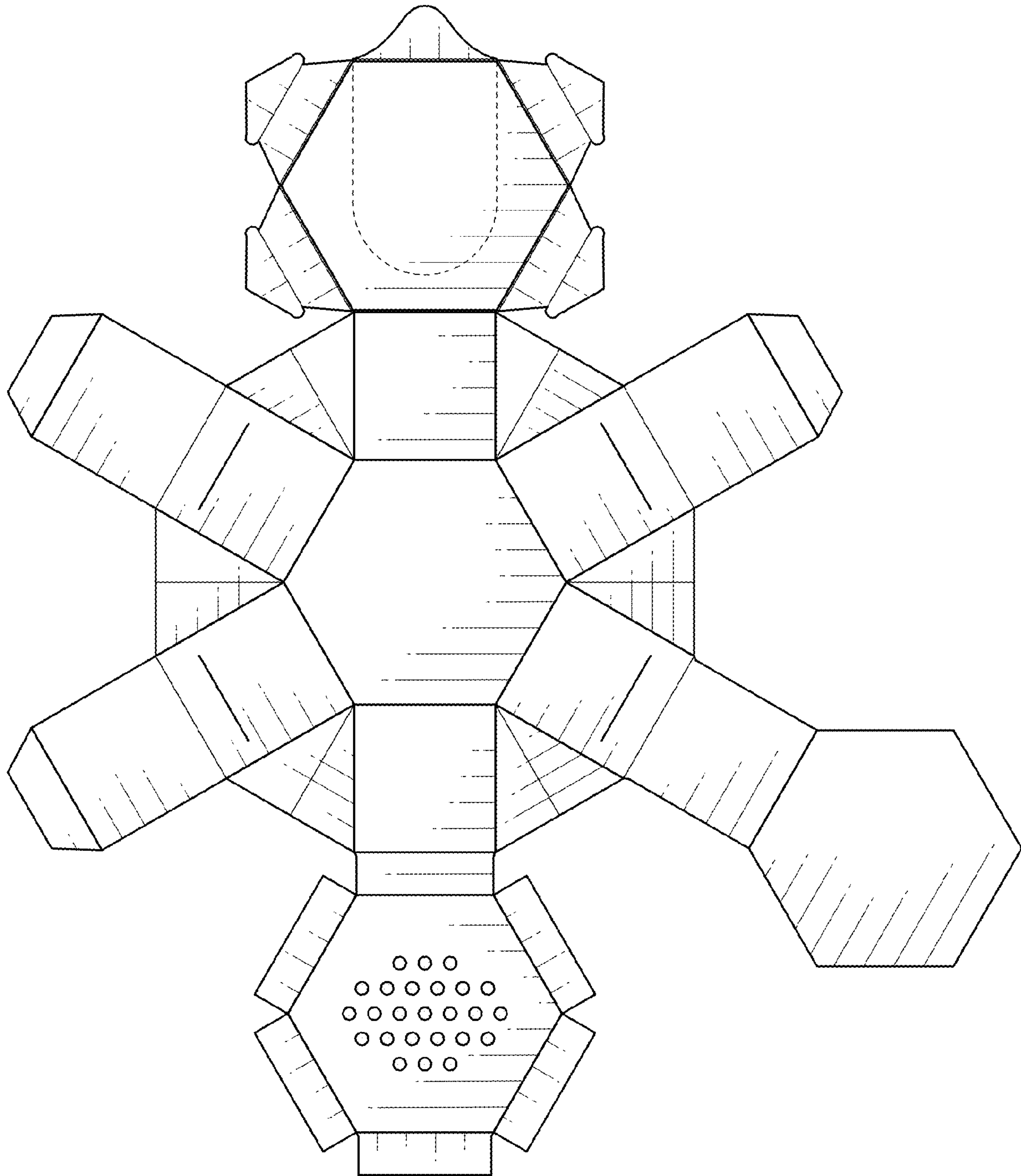

FIG. 10

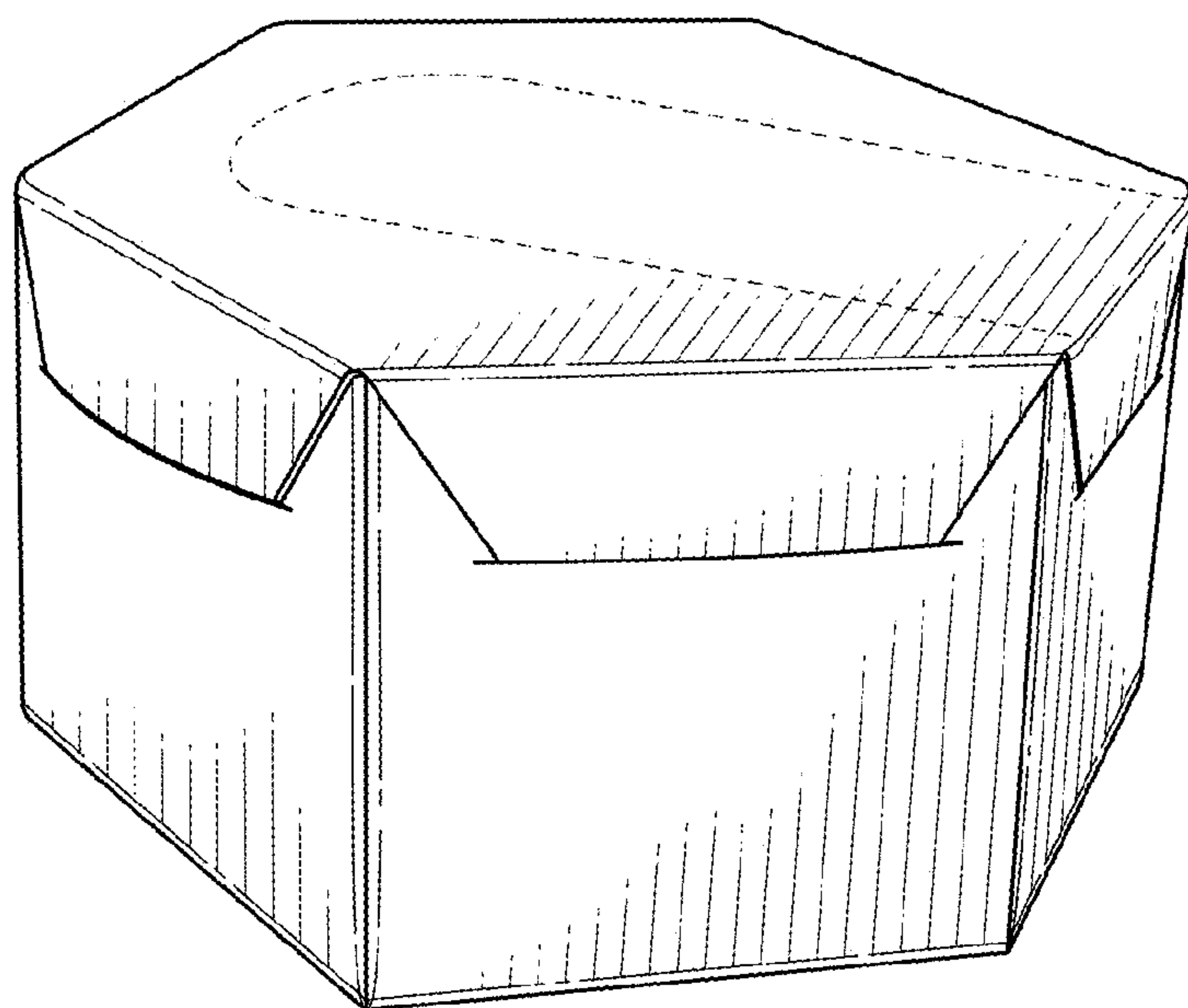

FIG. 11

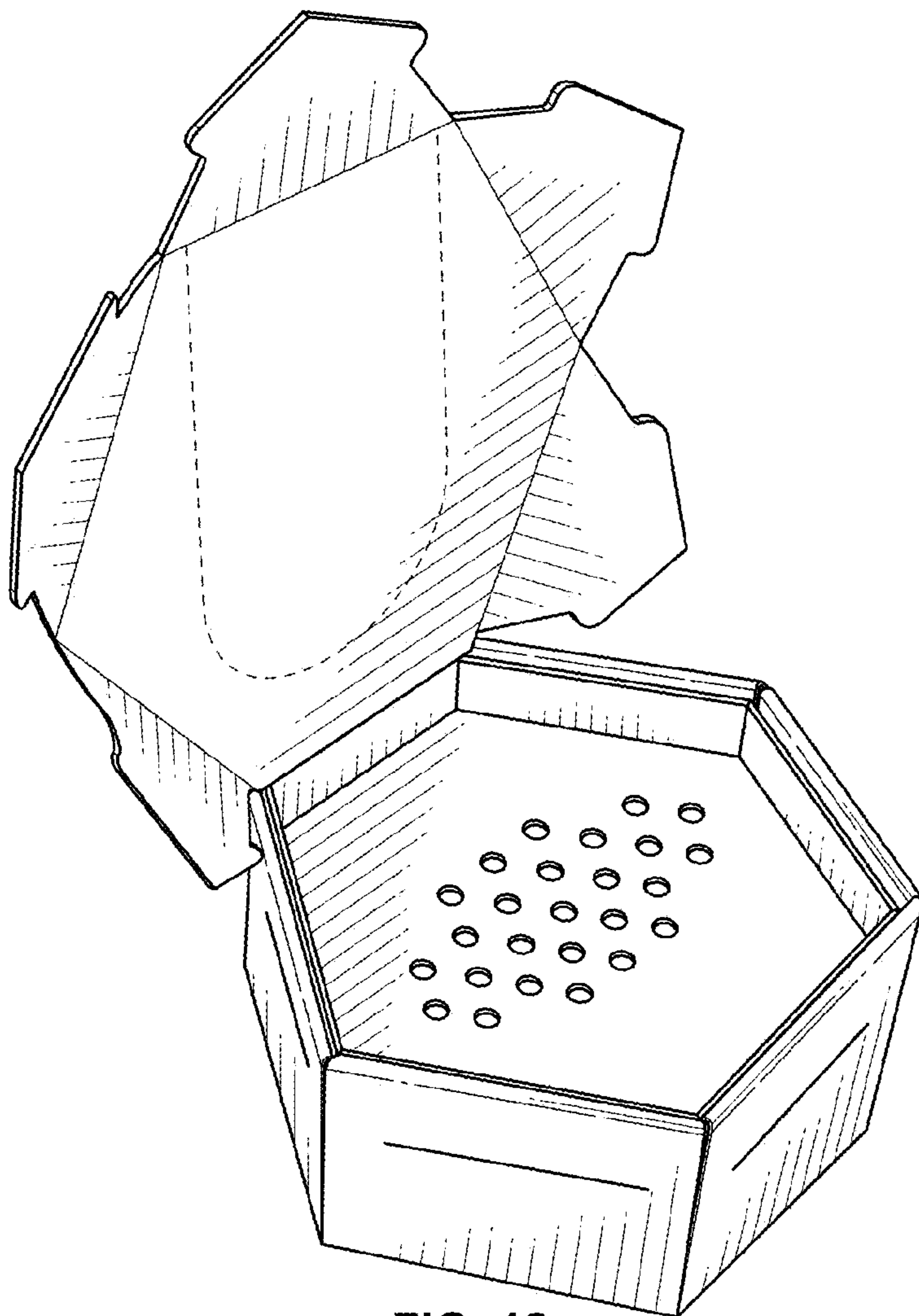

FIG. 12

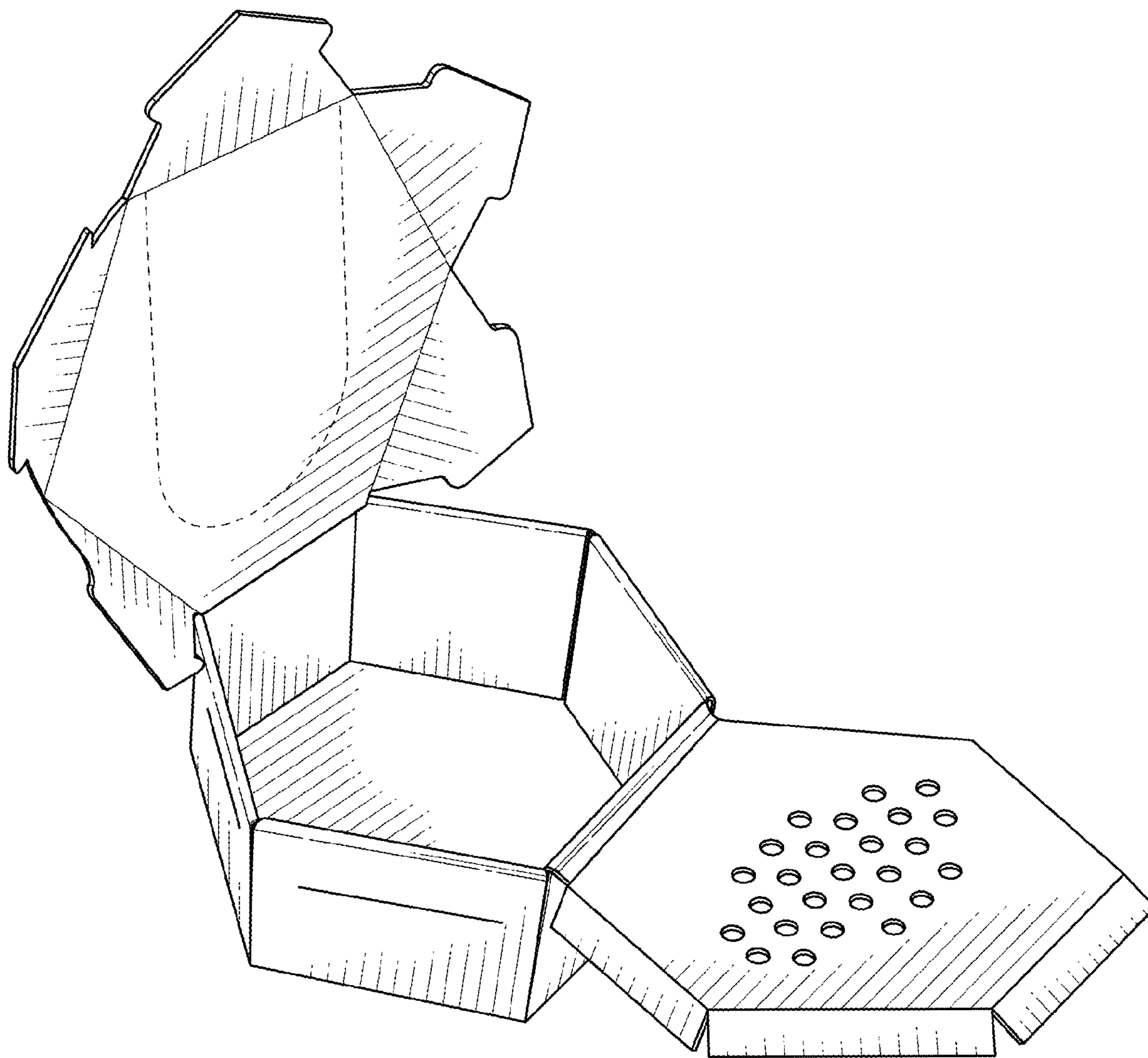

FIG. 13

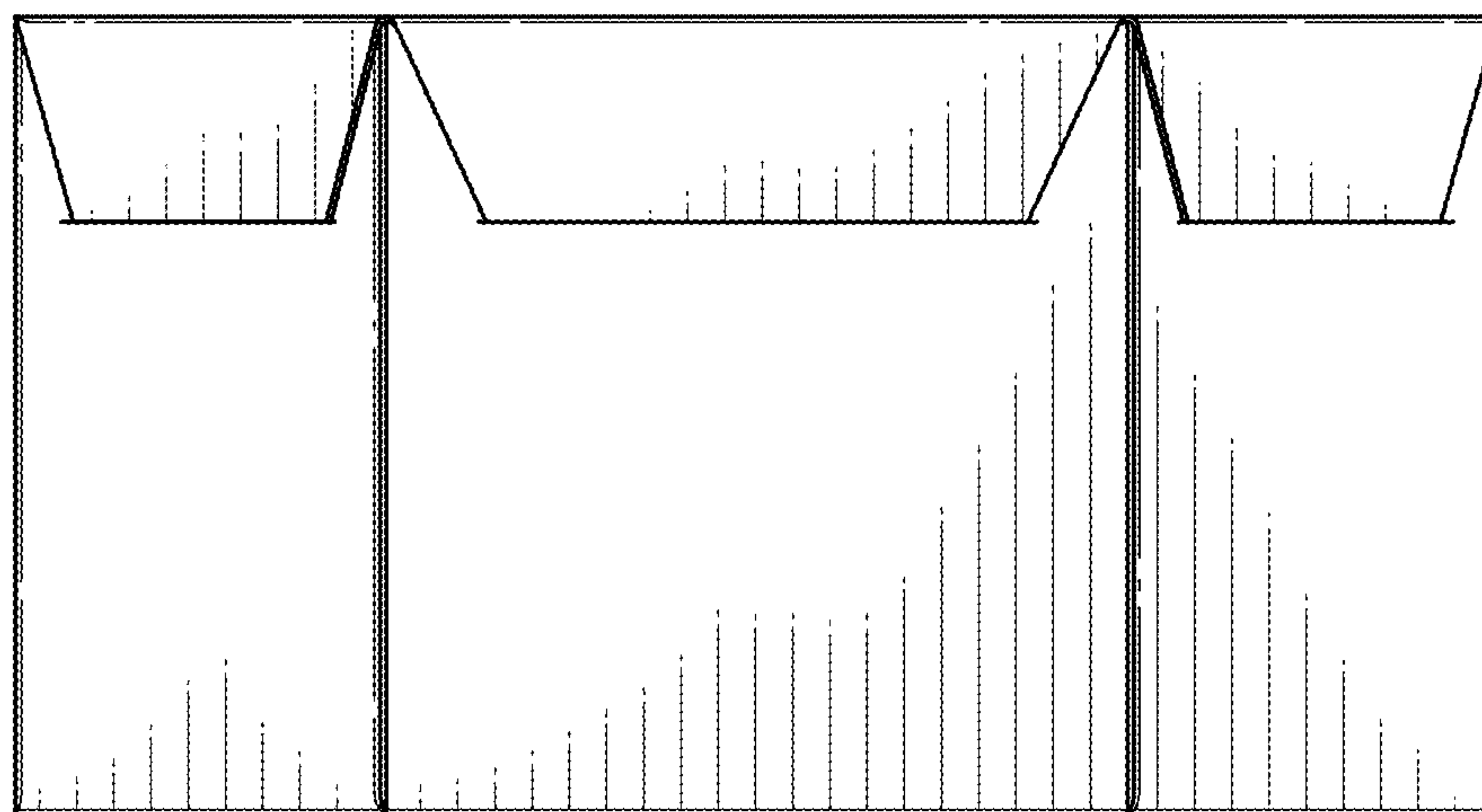

FIG. 14

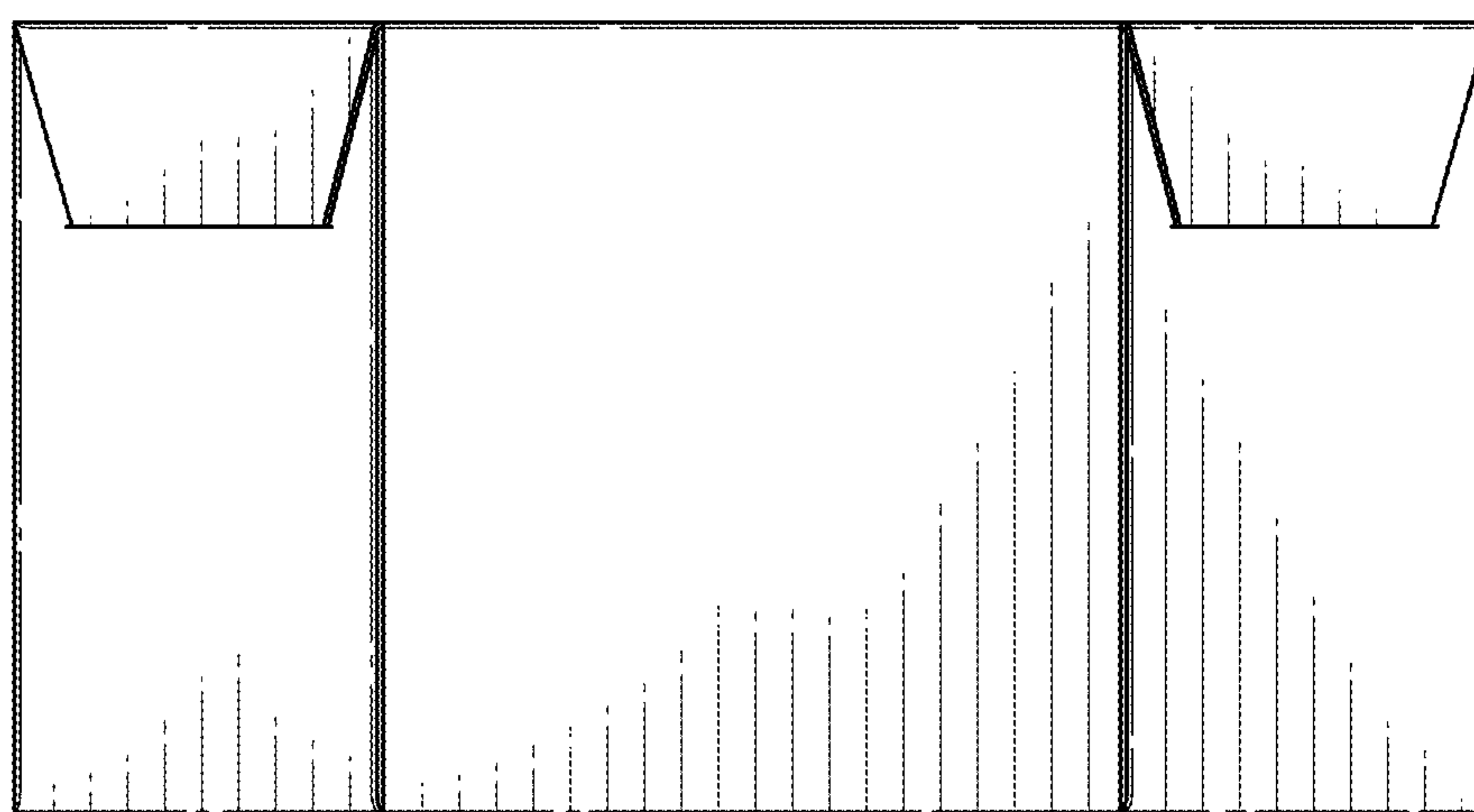

FIG. 15

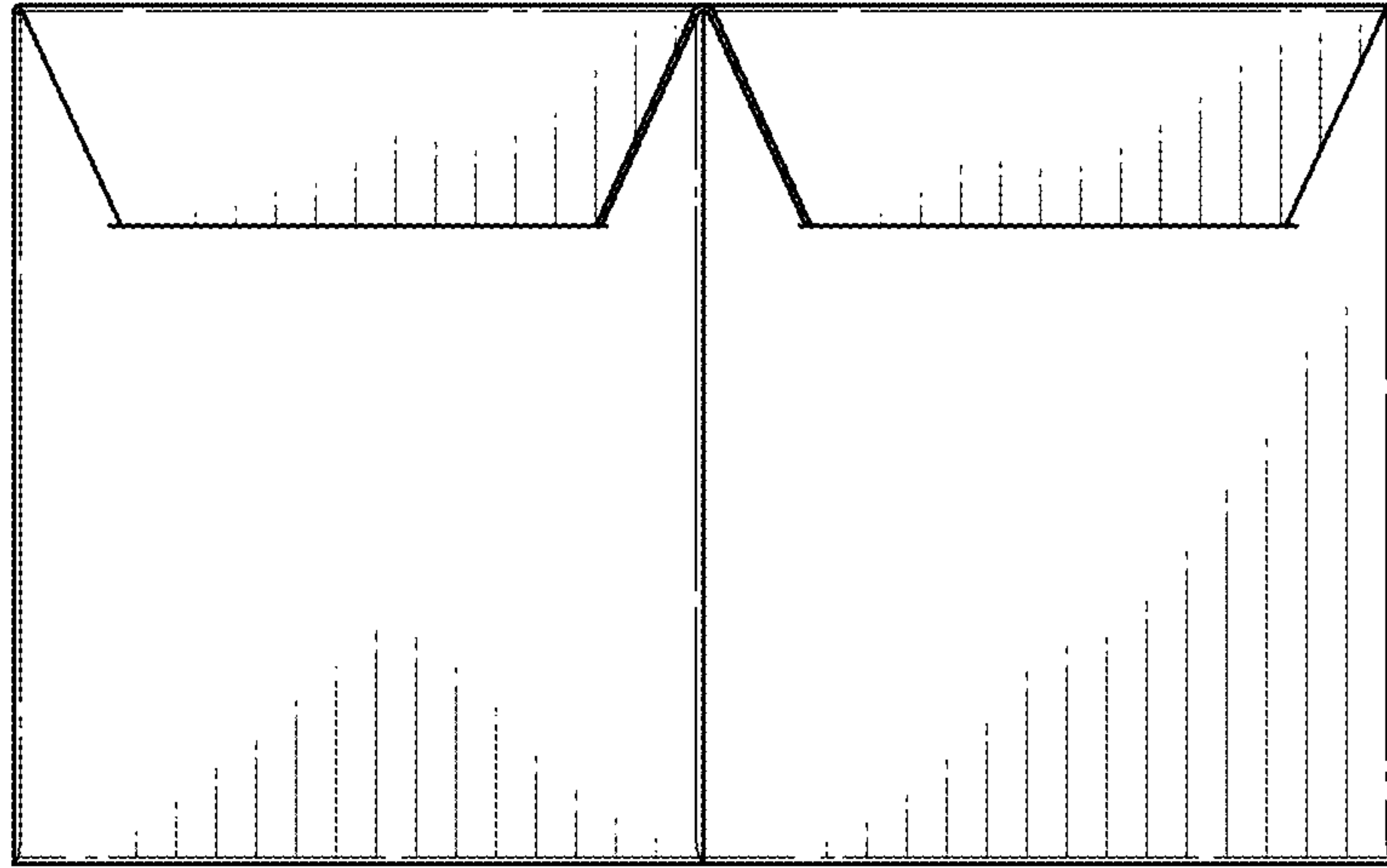

FIG. 16

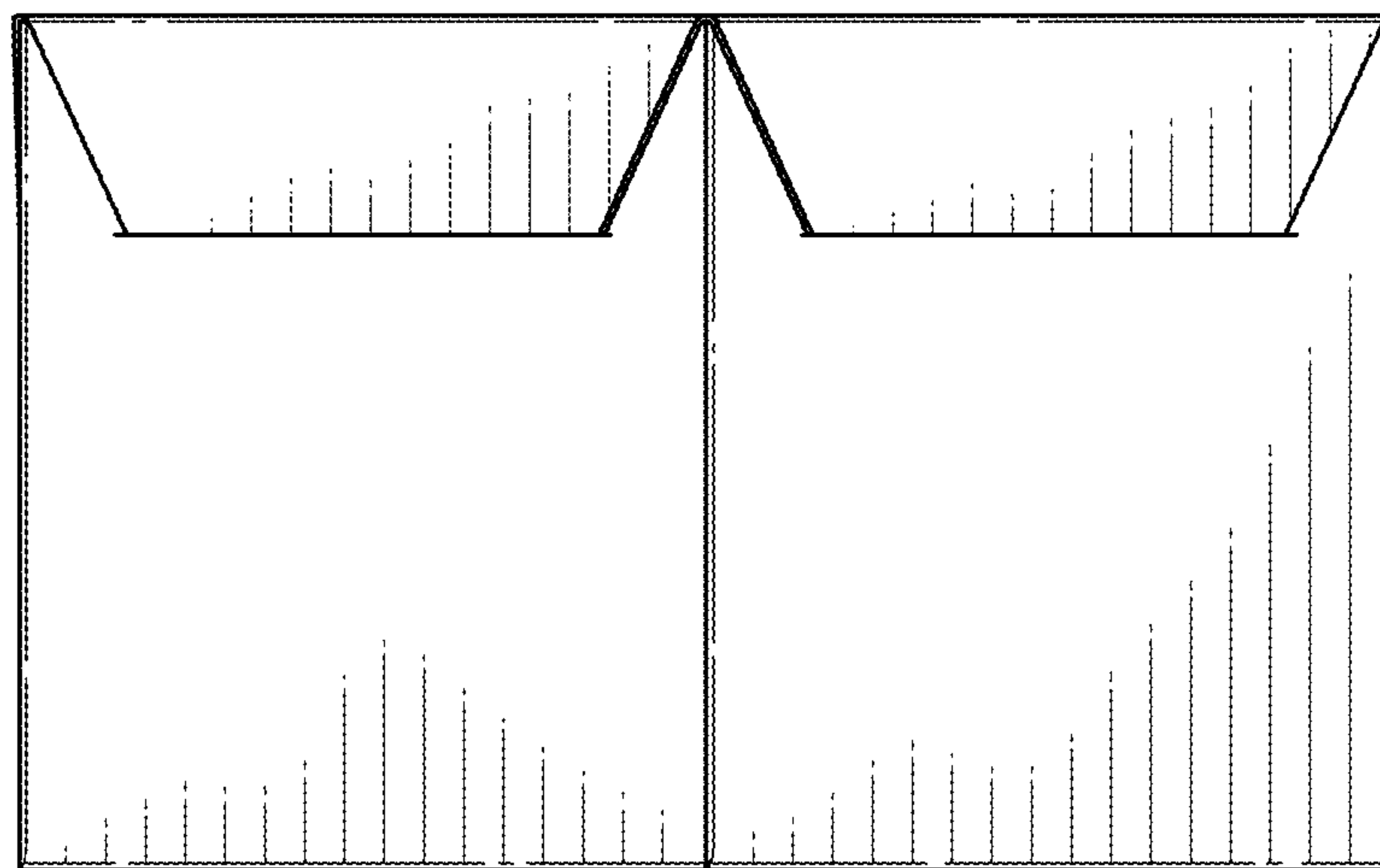

FIG. 17

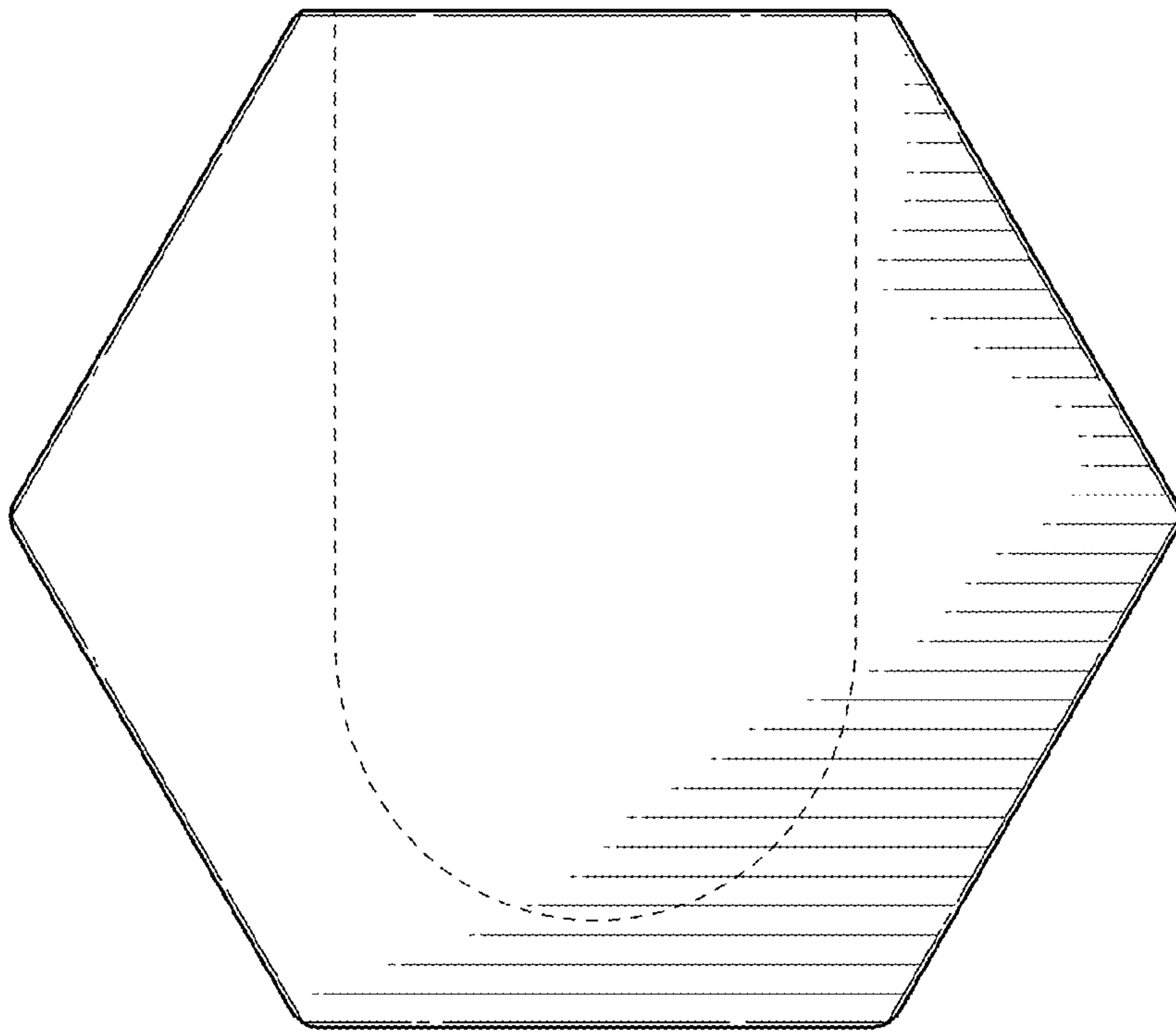

FIG. 18

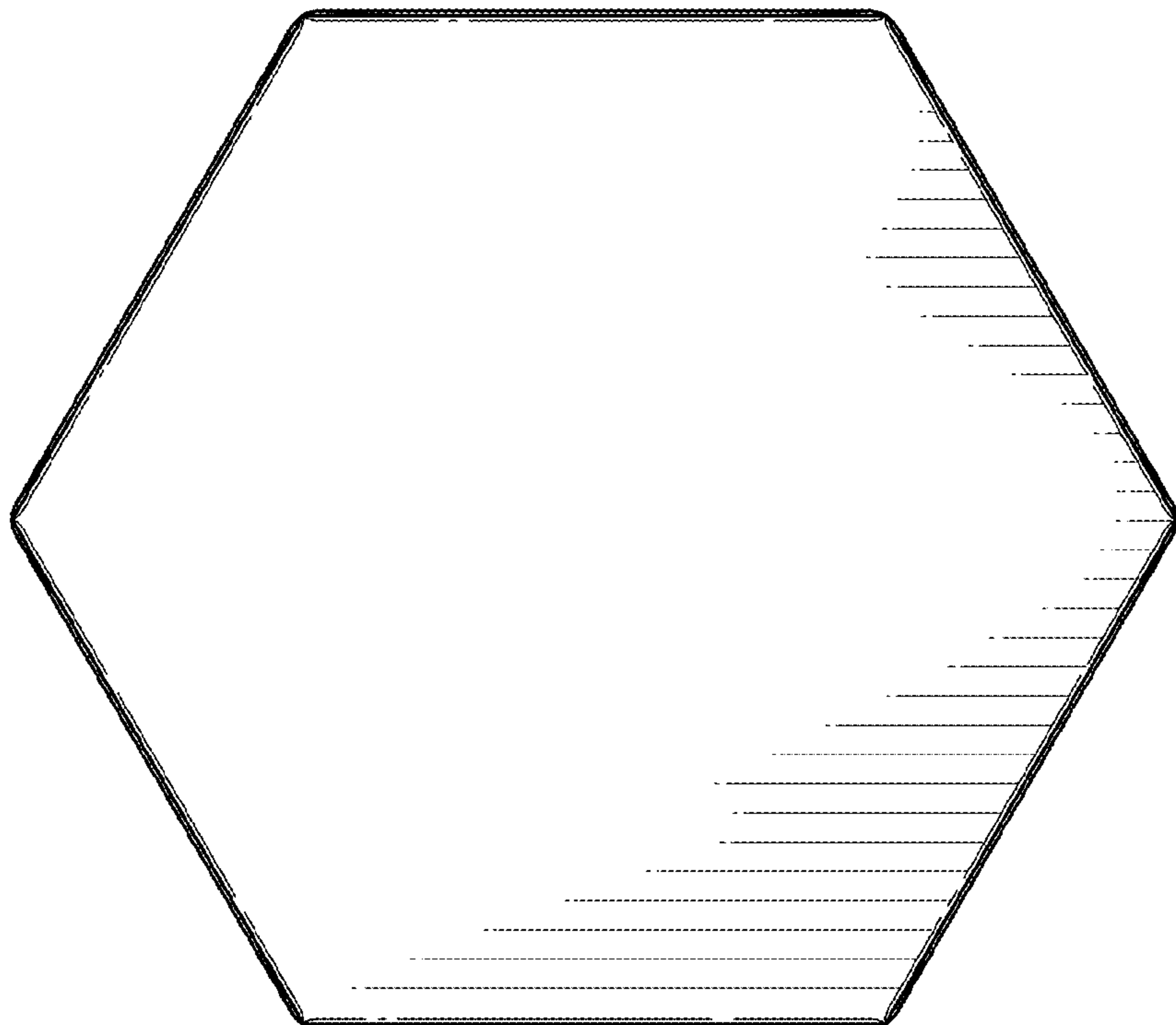

FIG. 19

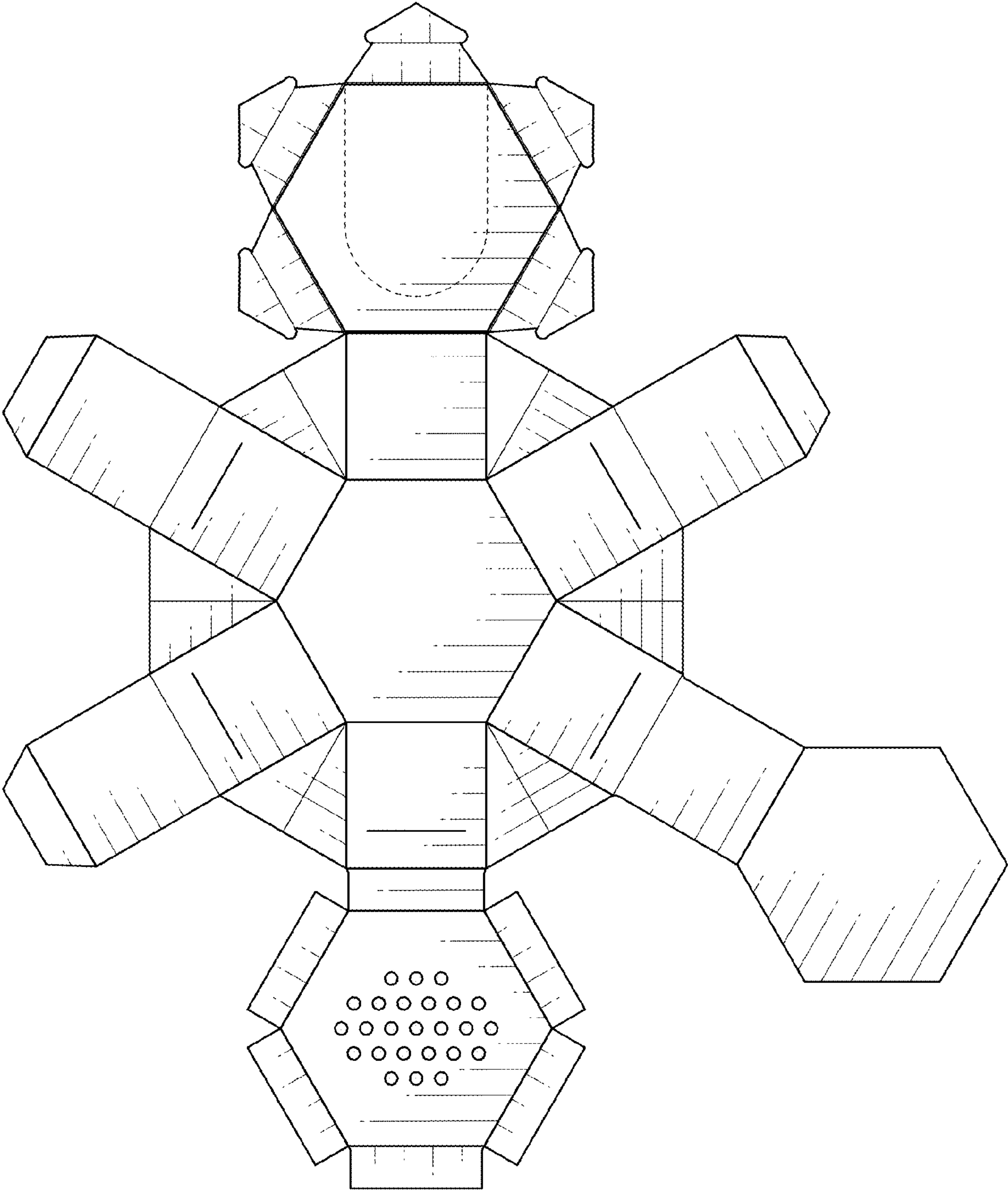

FIG. 20