



US00D875400S

(12) **United States Design Patent**  
**Burgess**

(10) **Patent No.:** **US D875,400 S**

(45) **Date of Patent:** **\*\* Feb. 18, 2020**

(54) **GOLF BAG TOP CUFF**

D525,034 S \* 7/2006 Vosloo ..... D3/320  
D632,890 S 2/2011 Reimers  
D669,266 S 10/2012 Loudenslager et al.

(71) Applicant: **Acushnet Company**, Fairhaven, MA  
(US)

\* cited by examiner

(72) Inventor: **Ian Burgess**, Tiverton, RI (US)

*Primary Examiner* — Holly H Baynham

(73) Assignee: **Acushnet Company**, Fairhaven, MA  
(US)

(74) *Attorney, Agent, or Firm* — Daniel W. Sullivan

(\*\*) Term: **15 Years**

(57) **CLAIM**

(21) Appl. No.: **29/665,265**

The ornamental design for a golf bag top cuff, as shown and described.

(22) Filed: **Oct. 2, 2018**

**DESCRIPTION**

(51) **LOC (12) Cl.** ..... **03-01**

(52) **U.S. Cl.**

USPC ..... **D3/318**; D3/255

(58) **Field of Classification Search**

USPC ..... D3/318, 255

CPC ..... A63B 55/00; A63B 57/00; A63B 55/404;

A63B 55/406; A63B 55/10; A63B 55/60;

A63B 55/40

See application file for complete search history.

FIG. 1 is a first perspective view of the golf bag top cuff of this invention;

FIG. 2 is a rear view of the golf bag top cuff of this invention;

FIG. 3 is a first side view of the golf bag top cuff of this invention;

FIG. 4 is a front view of the golf bag top cuff of this invention;

FIG. 5 is a second side view of the golf bag top cuff of this invention; and,

FIG. 6 is a top plan view of the golf bag top cuff of this invention.

In FIGS. 1-6, the broken lines depict unclaimed portions of the golf bag. The broken lines visible on the surface of the top cuff of the golf bag in FIGS. 1-6 represent claimed stitching. The dot-dashed boundary line visible in FIGS. 1 and 6 represents the bounds of the claim and forms no part of the claimed design.

(56) **References Cited**

U.S. PATENT DOCUMENTS

D364,737 S \* 12/1995 Perrin ..... D3/255

D382,397 S \* 8/1997 Wu ..... D3/255

D405,607 S \* 2/1999 Sundara ..... D3/255

6,109,433 A \* 8/2000 Pratt ..... A63B 55/40  
206/315.6

6,513,653 B1 2/2003 Chen

D489,532 S 5/2004 Reimers

D517,808 S 3/2006 Reimers

**1 Claim, 4 Drawing Sheets**

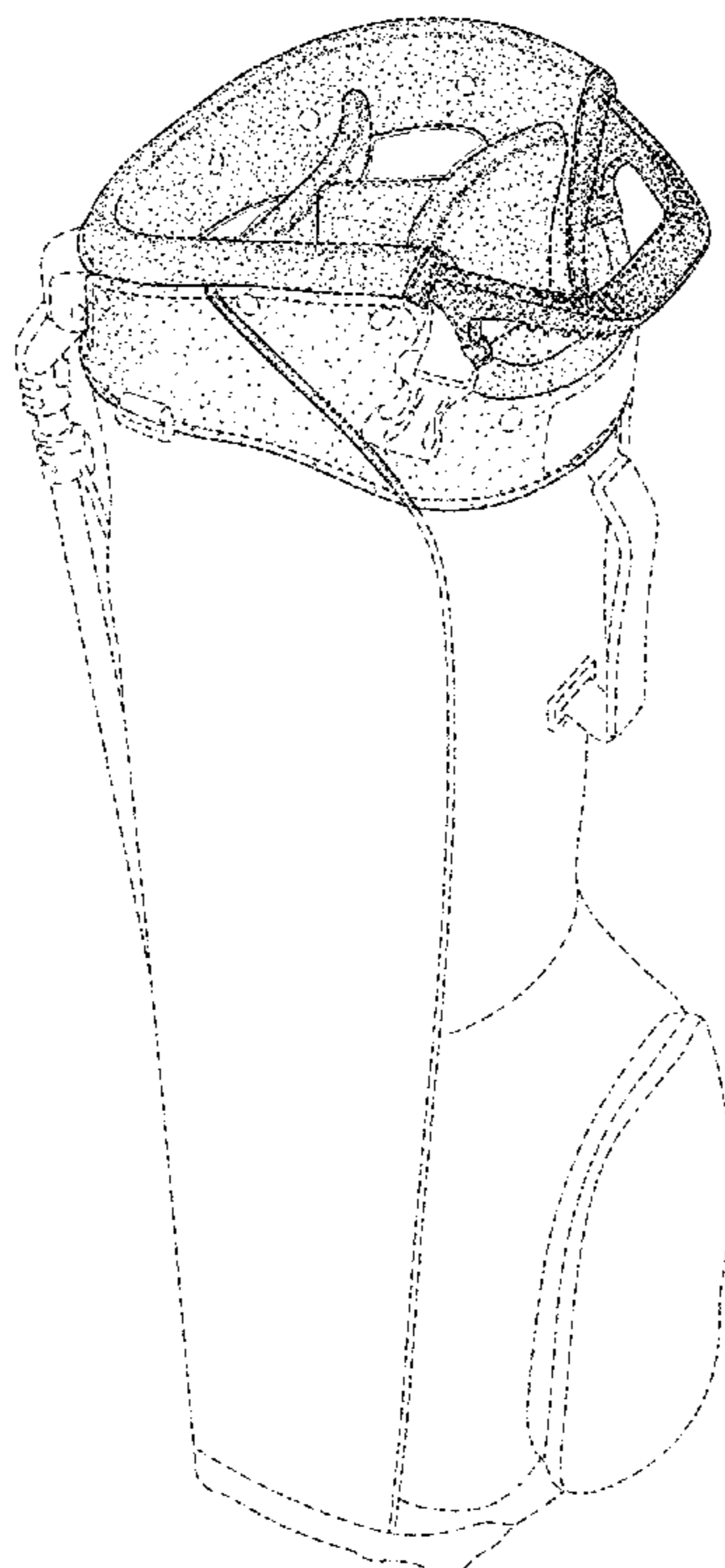

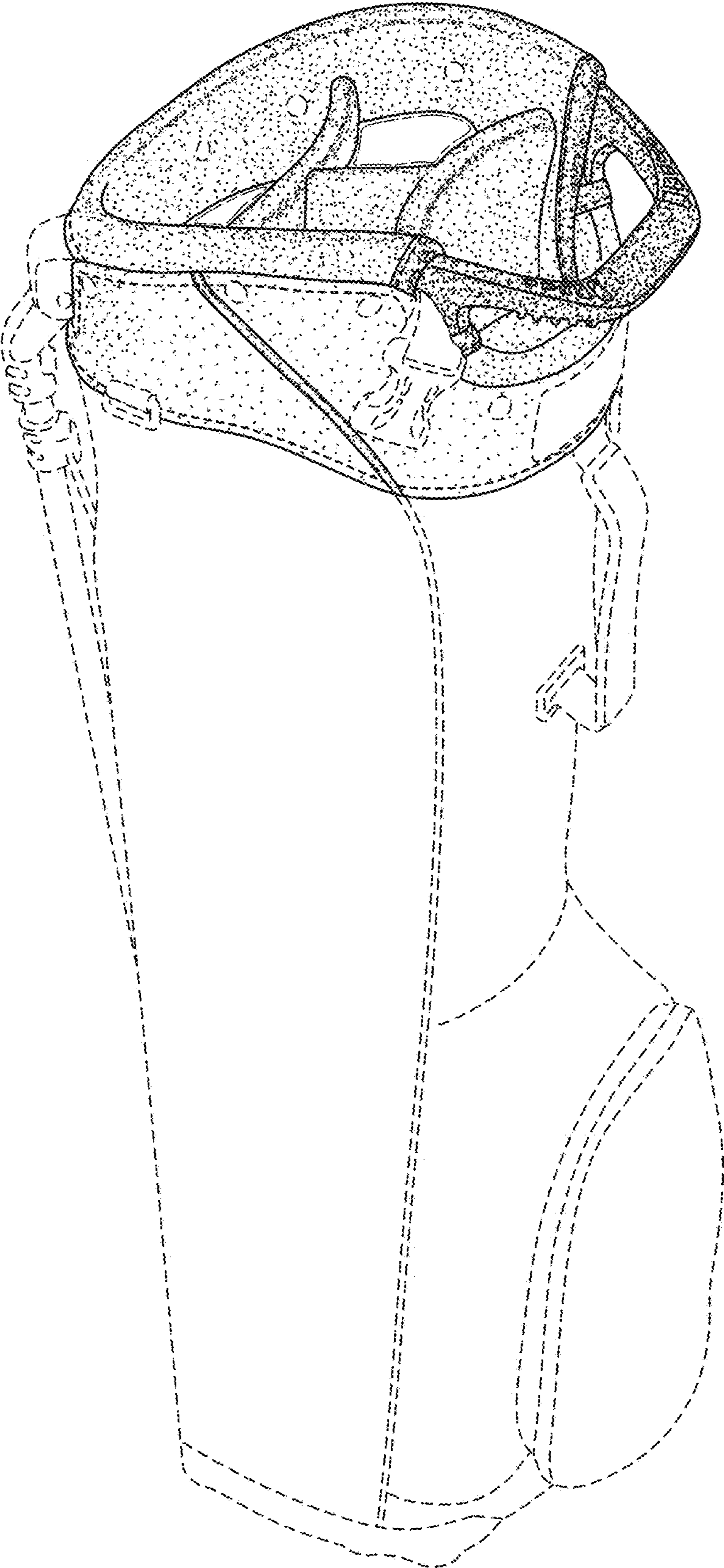

FIG. 1



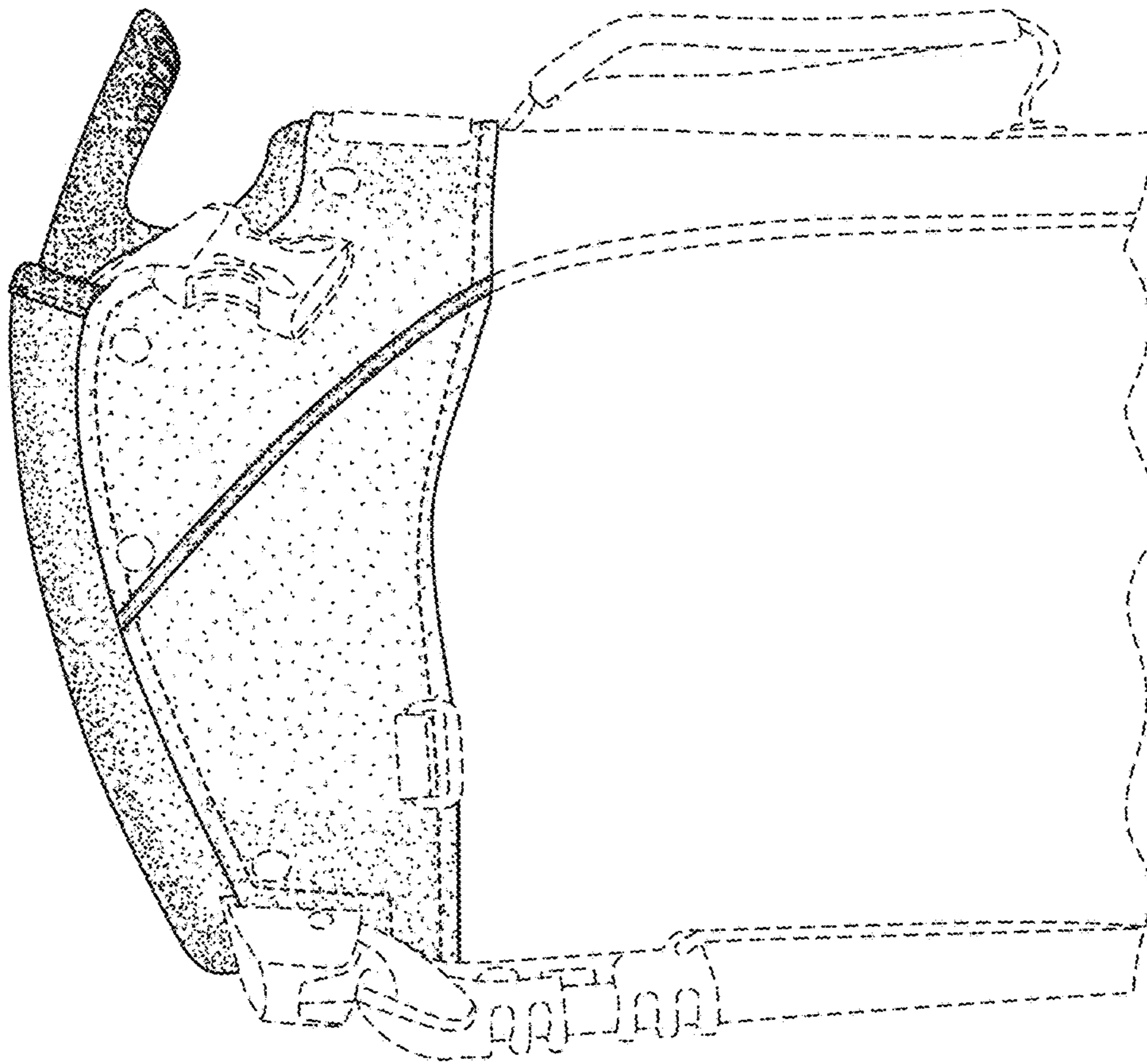

FIG. 3

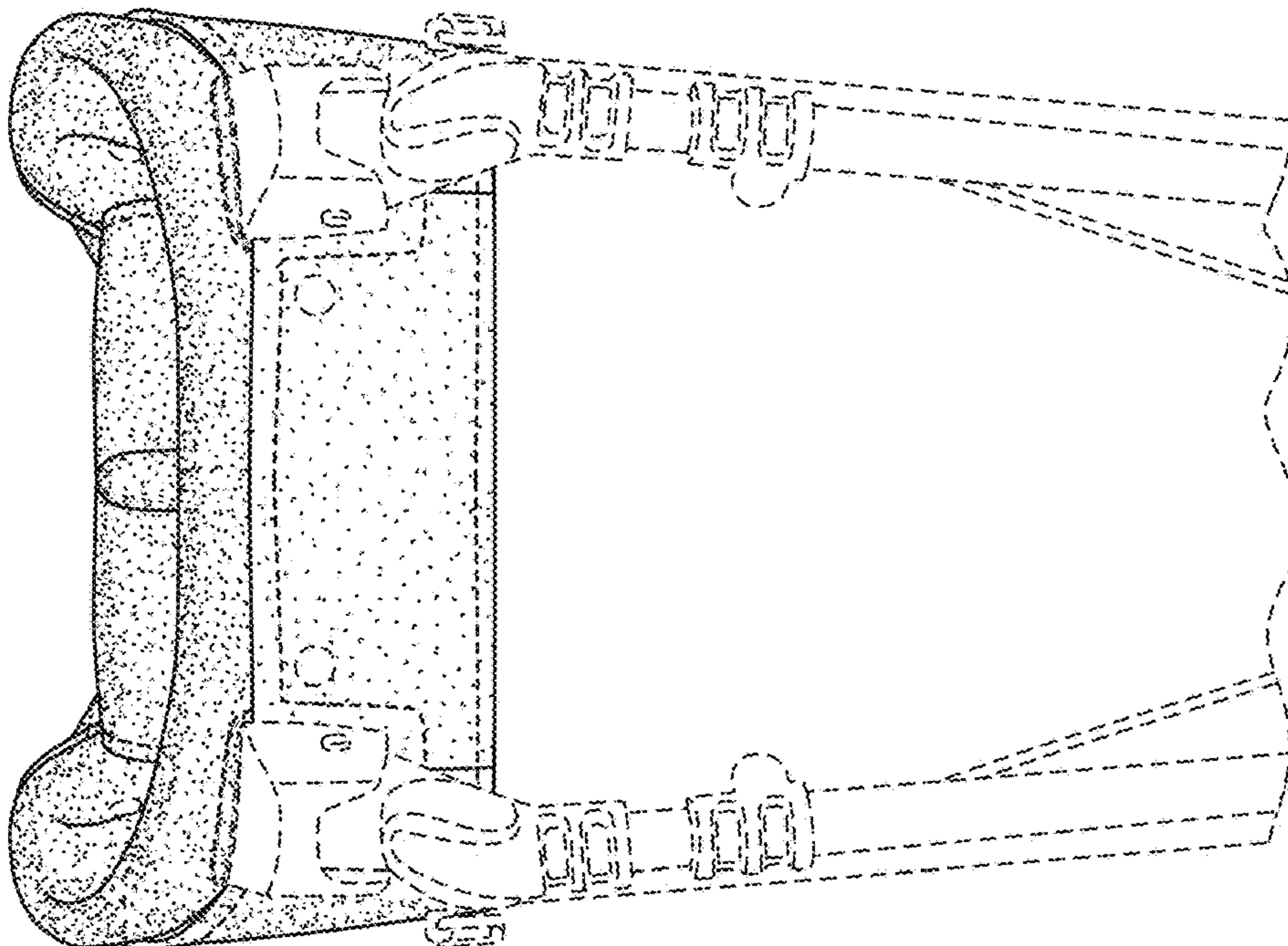

FIG. 2

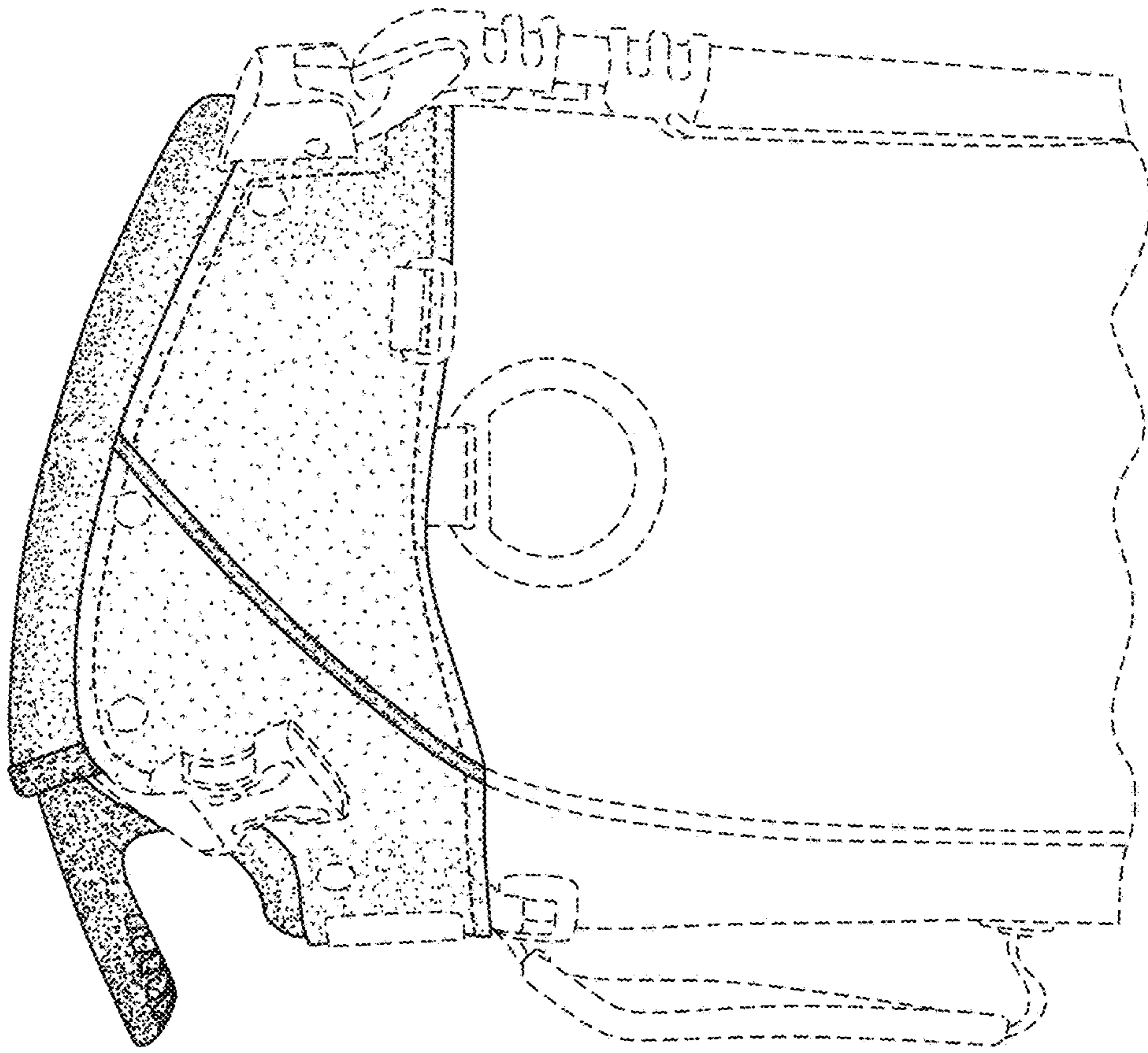

FIG. 5

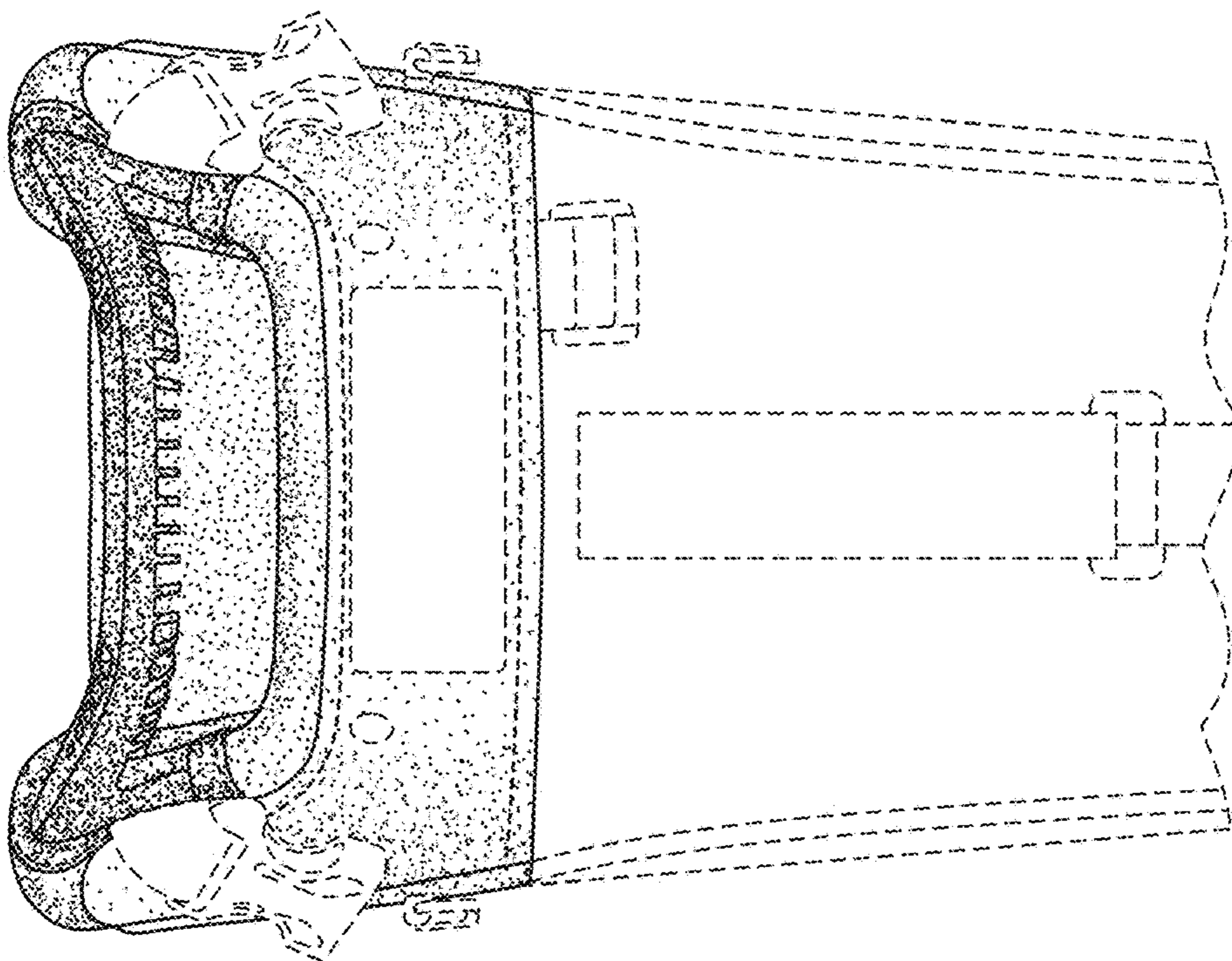

FIG. 4



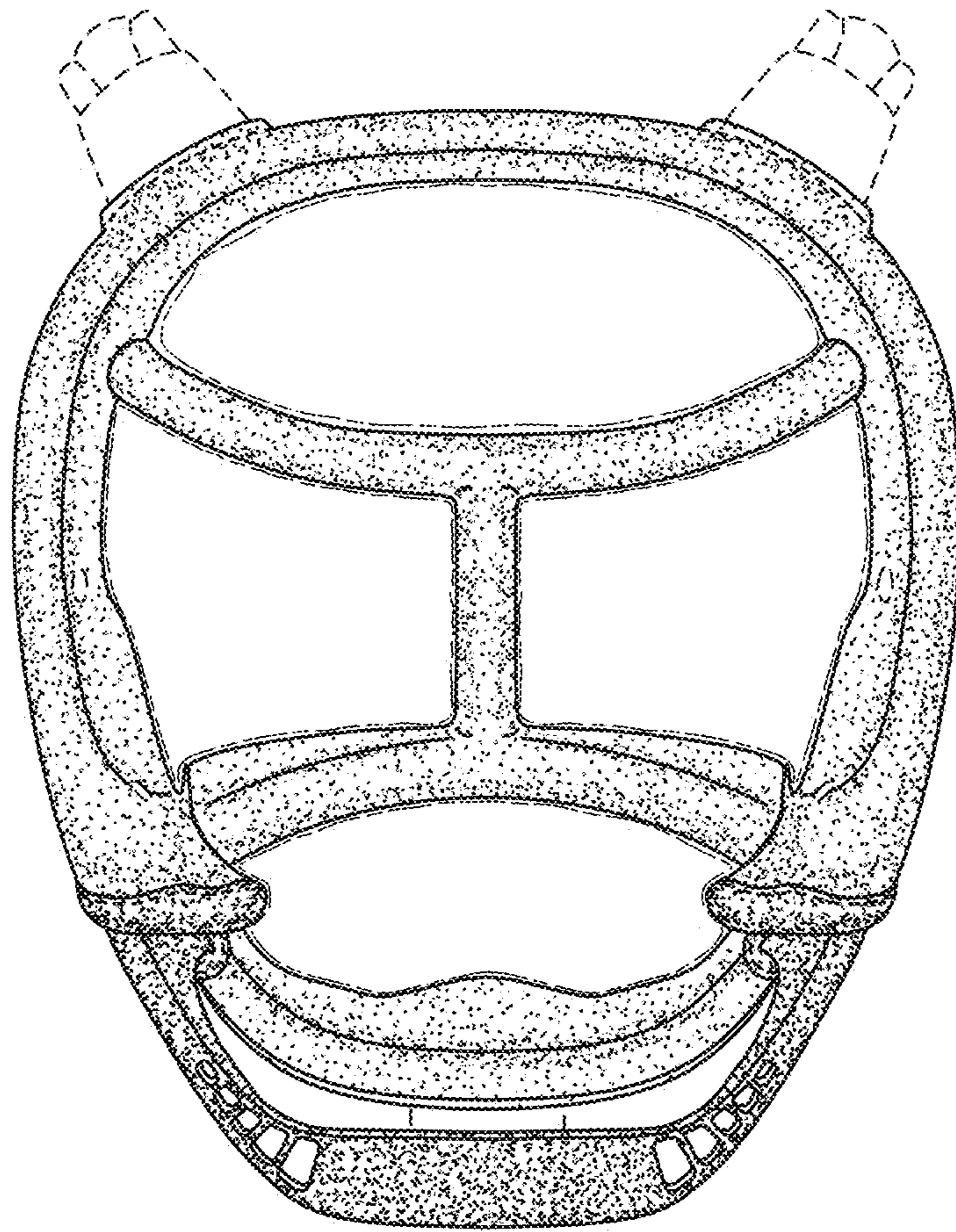

FIG. 6