



US00D875318S

(12) **United States Design Patent** (10) **Patent No.:** **US D875,318 S**
Hsieh et al. (45) **Date of Patent:** **** Feb. 11, 2020**

(54) **PHOTOCURING DEVICE**

(71) Applicant: **COSMEX CO., LTD.**, New Taipei (TW)

(72) Inventors: **Wan Chieh Hsieh**, New Taipei (TW);
Hao-Hong Ciou, New Taipei (TW);
Lin-Yu Sia, New Taipei (TW); **Chun Ching Liu**, New Taipei (TW)

(73) Assignee: **COSMEX CO. LTD.**, New Taipei (TW)

(**) Term: **15 Years**

(21) Appl. No.: **29/641,126**

(22) Filed: **Mar. 20, 2018**

(30) **Foreign Application Priority Data**

Sep. 20, 2017 (TW) 106305570

(51) **LOC (12) Cl.** **28-03**

(52) **U.S. Cl.**
USPC **D28/58**

(58) **Field of Classification Search**

USPC D28/56-58, 54.1
CPC A45D 29/00; A45D 2200/15-155; A45D 2200/205; A45D 29/20; A45D 29/007
See application file for complete search history.

(56) **References Cited**

U.S. PATENT DOCUMENTS

D492,447 S * 6/2004 Mills D28/54.1
D692,617 S * 10/2013 Haile D28/58
D702,400 S * 4/2014 Valia D28/54.1
D704,889 S * 5/2014 Chiu D28/54.1
D715,494 S * 10/2014 Kim D28/54.1
D734,548 S * 7/2015 Dadon D28/54.1
D745,741 S * 12/2015 Jih D28/54.1
D751,761 S * 3/2016 Jih D28/54.1
D755,442 S * 5/2016 Jih D28/54.1
D765,913 S * 9/2016 Dadon D28/58

D805,692 S * 12/2017 Cheng D28/58
10,117,494 B1 * 11/2018 Luu G21K 5/02
2016/0089694 A1 * 3/2016 Jih B05D 3/067
34/202
2018/0325234 A1 * 11/2018 Hsieh A45D 29/00

OTHER PUBLICATIONS

Gelish 18G LED Light, www.amazon.com, 1 page, reviewed as early as Apr. 2013.*

Cosmex LED Lamps, www.cosmex-tek.com, 1 page, downloaded Dec. 2018.*

* cited by examiner

Primary Examiner — Jennifer Rivard

(74) *Attorney, Agent, or Firm* — Muncy, Geissler, Olds & Lowe, P.C.

(57) **CLAIM**

The ornamental design for a photocuring device, as shown and described.

DESCRIPTION

FIG. 1 is a front, top, right perspective view of a photocuring device, showing our new design;
FIG. 2 is a front elevational view thereof;
FIG. 3 is a rear elevational view thereof;
FIG. 4 is a left side elevational view thereof;
FIG. 5 is a right side elevational view thereof;
FIG. 6 is a top plan view thereof;
FIG. 7 is a bottom plan view thereof; and,
FIG. 8 is an additional rear view showing the photocuring device in a state of use.

The dash dot dash broken lines illustrate the boundary of the design. The remaining broken lines illustrate portions of the photocuring device. None of the broken lines form part of the claimed design.

Nail Alliance is the owner of the registered trademark "Gelish".

1 Claim, 8 Drawing Sheets

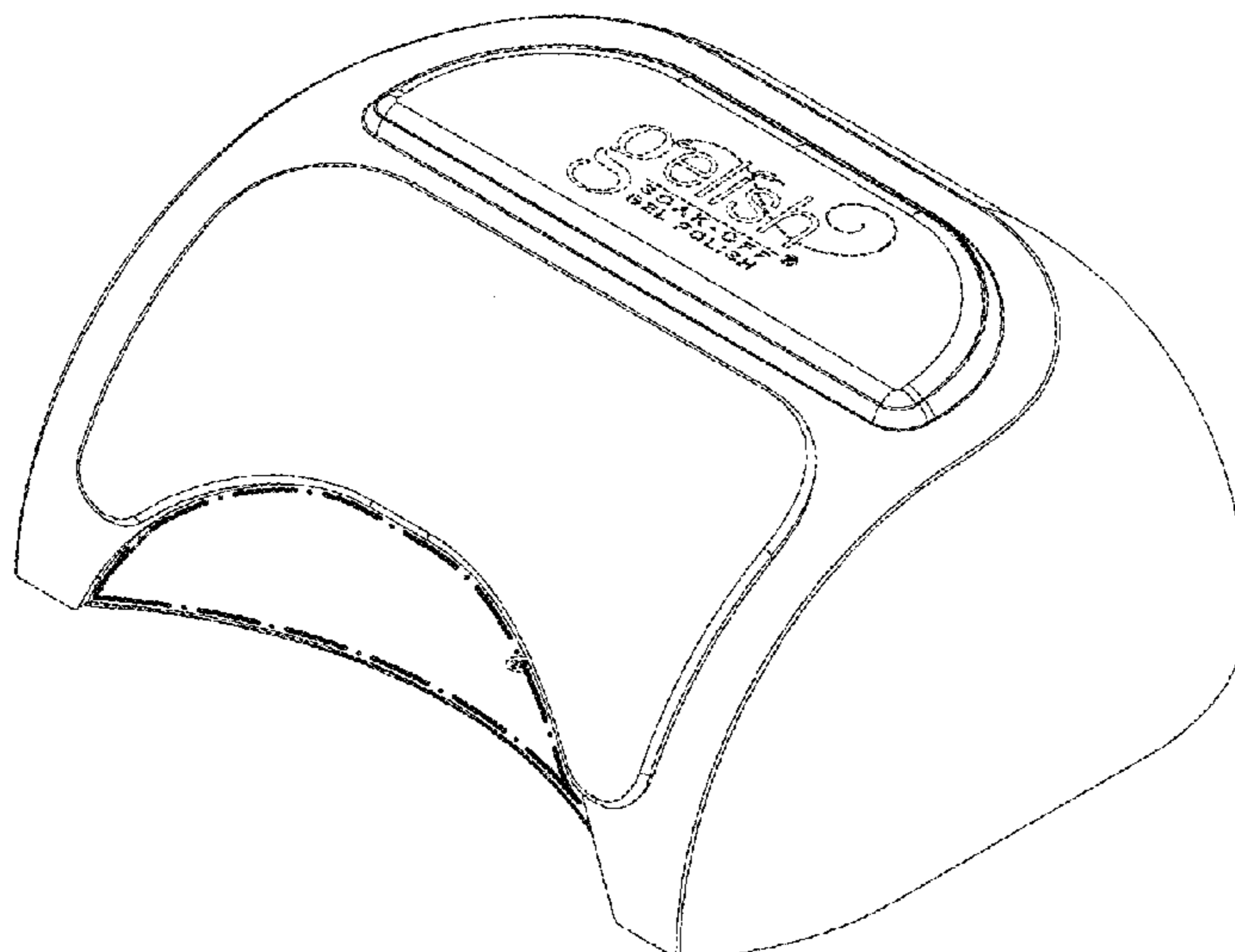

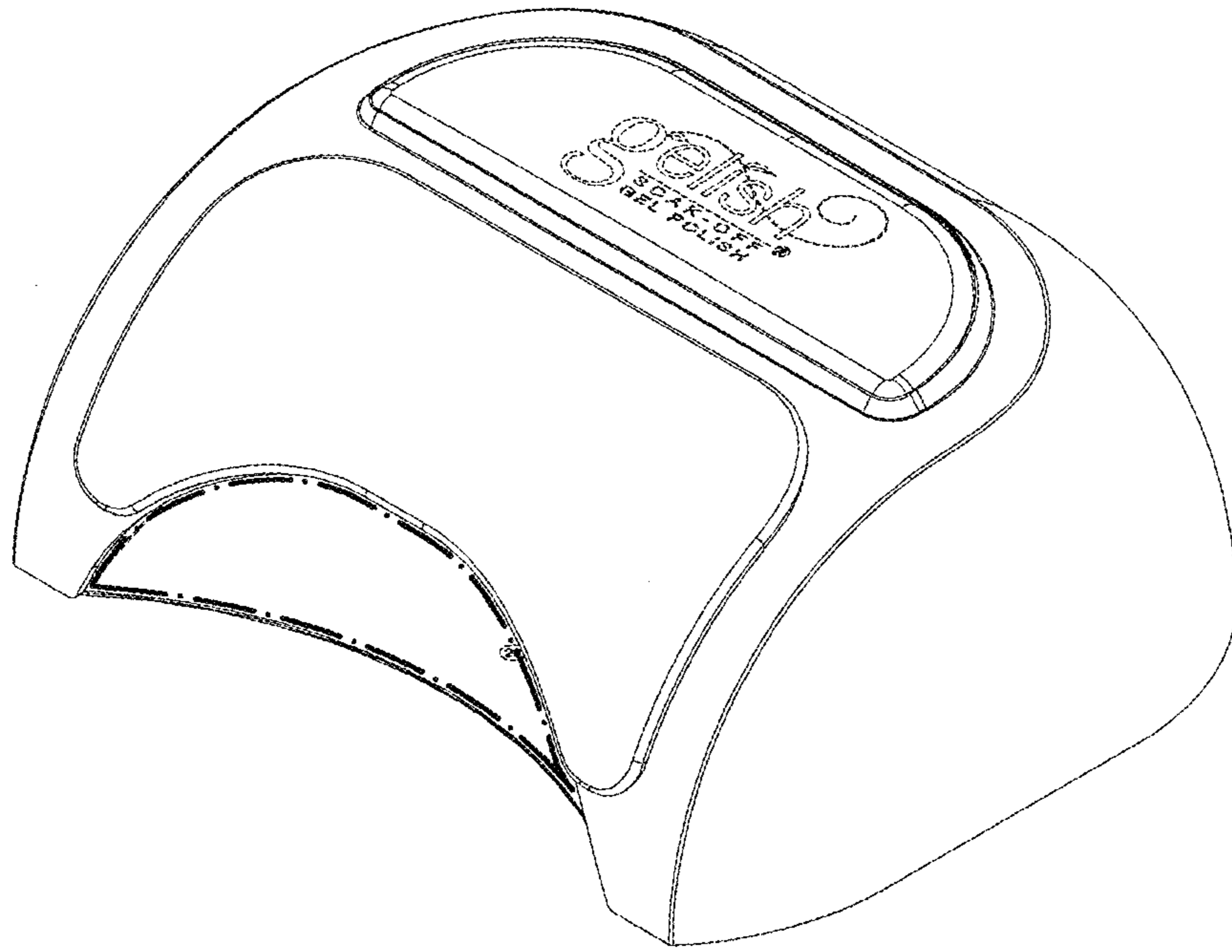

Fig.1

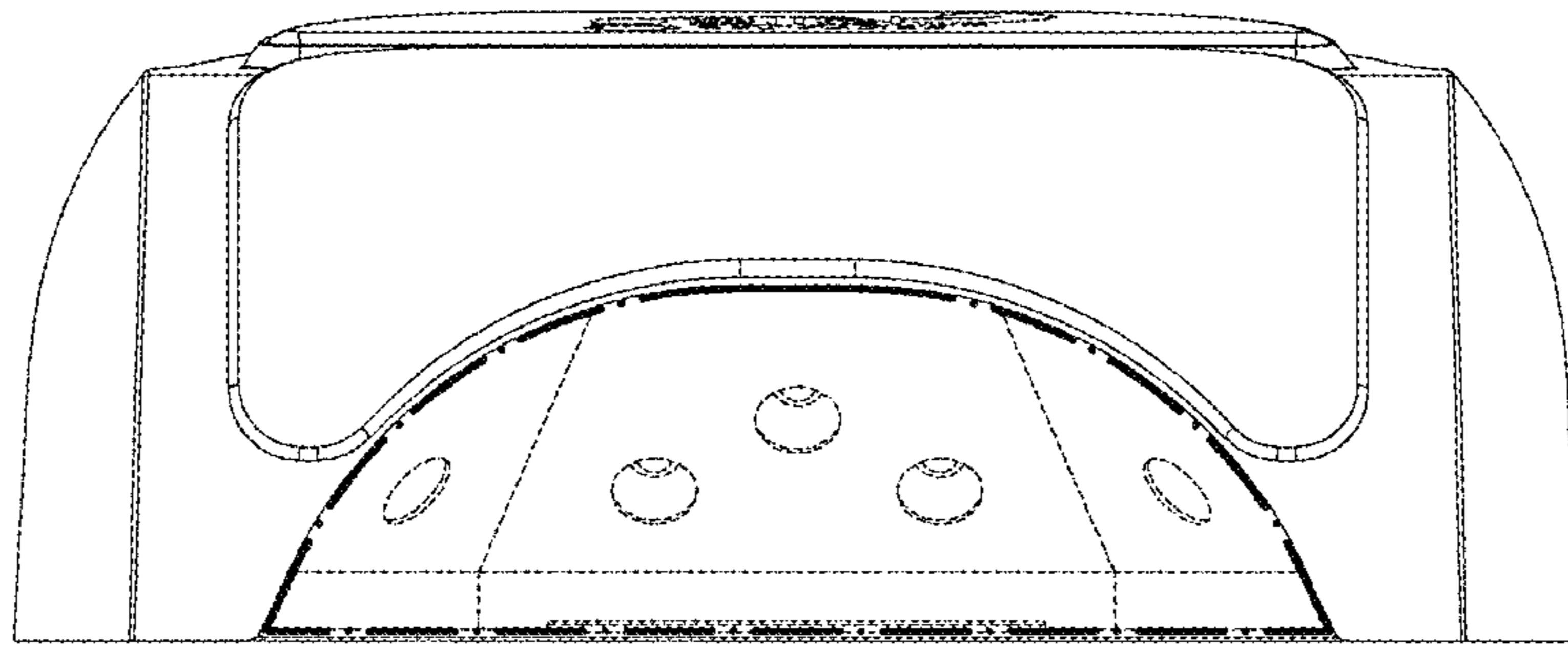

Fig.2

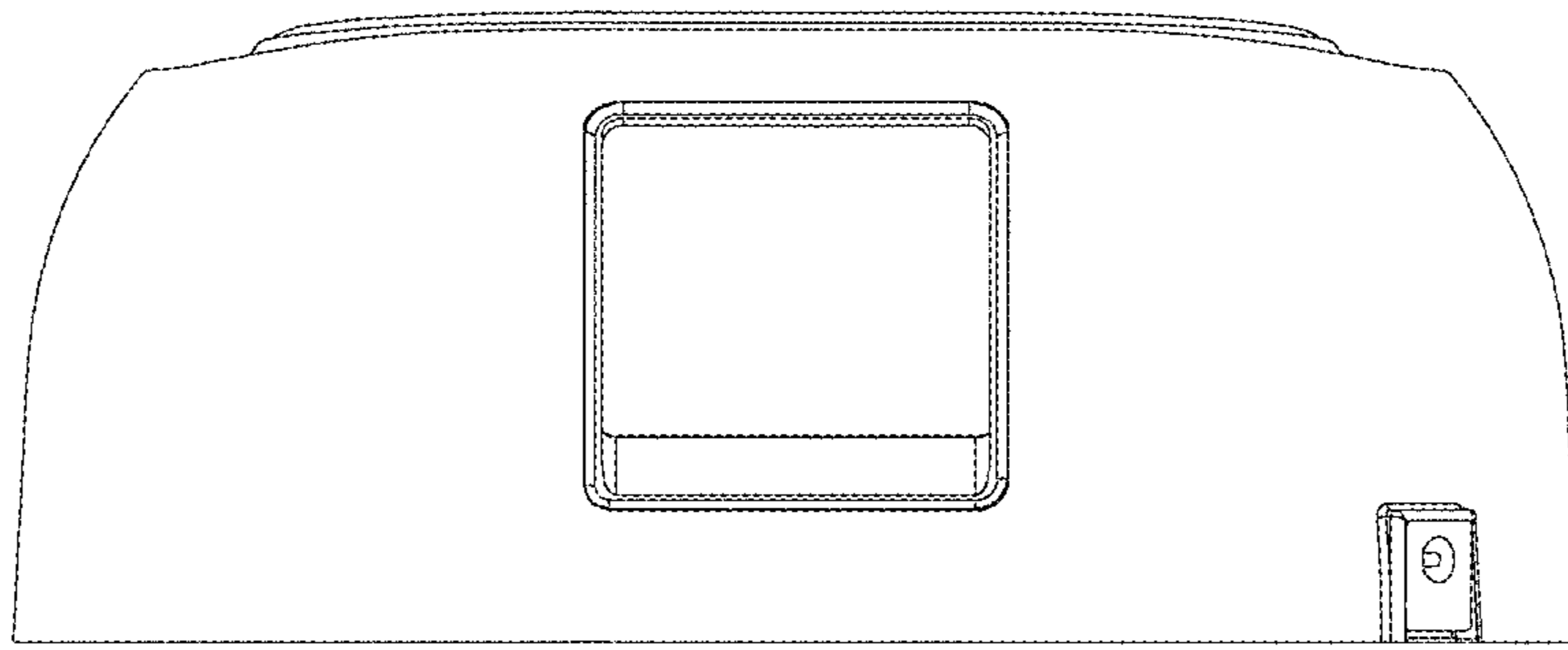

Fig.3

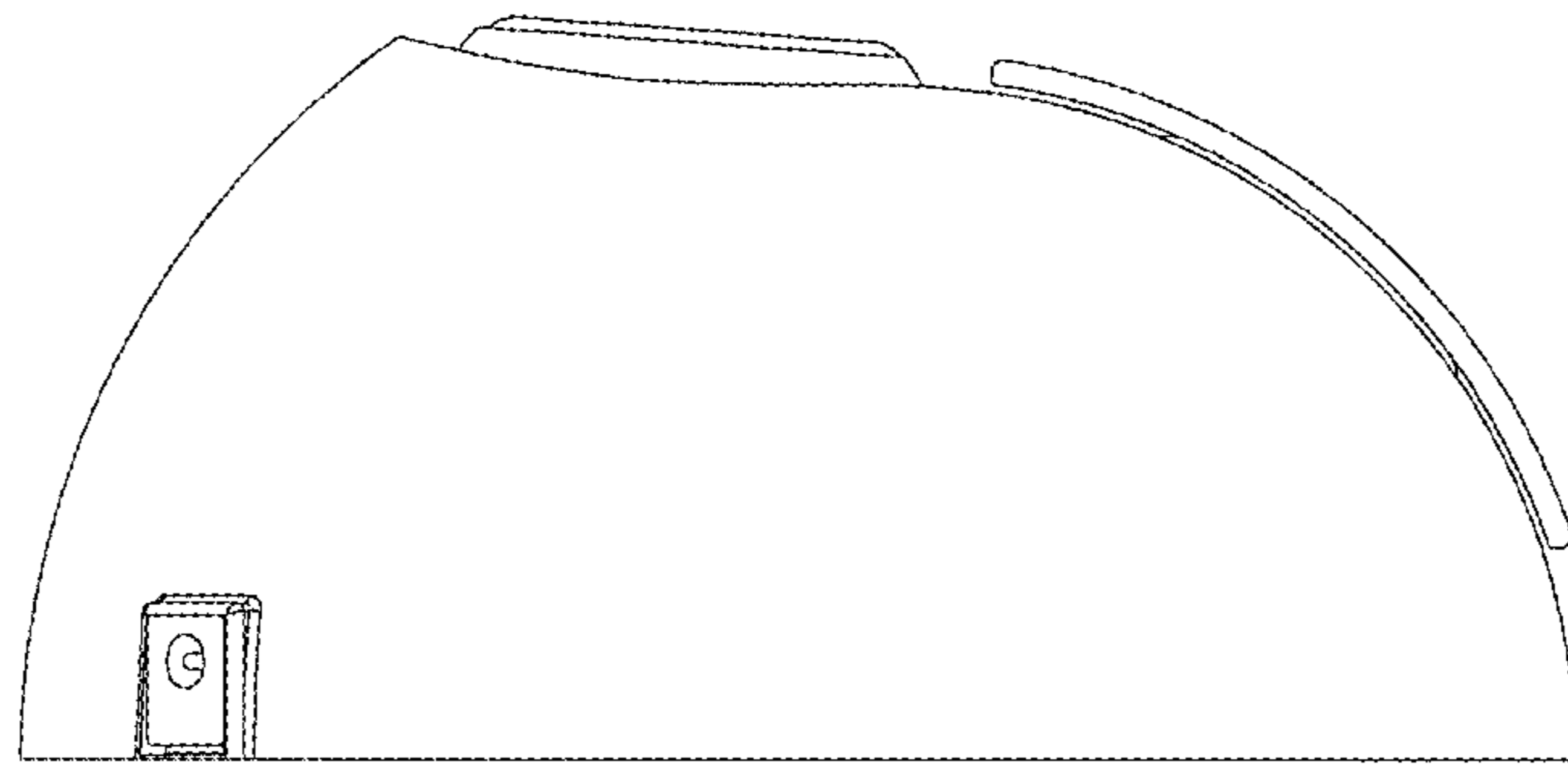

Fig.4

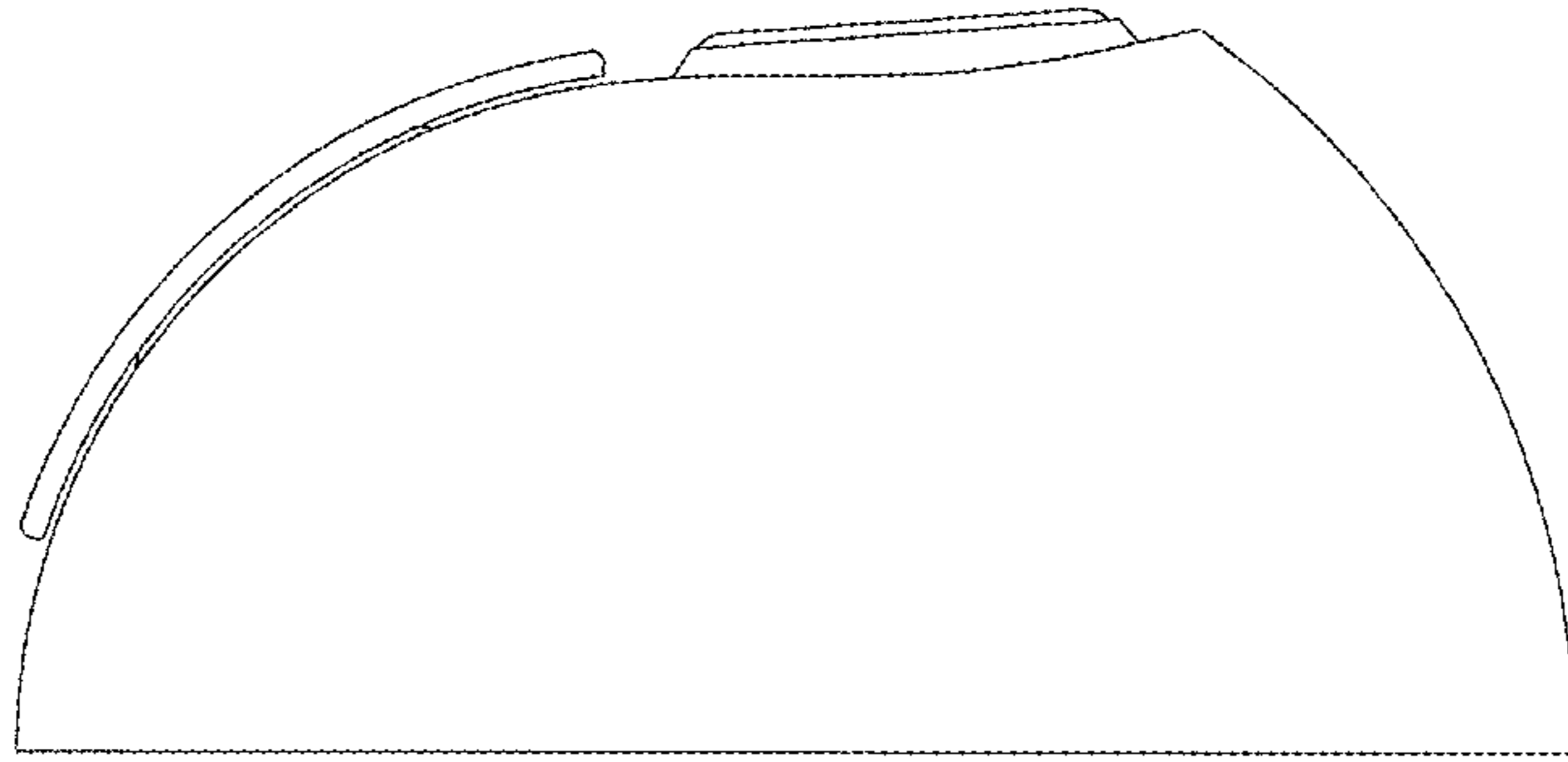

Fig.5

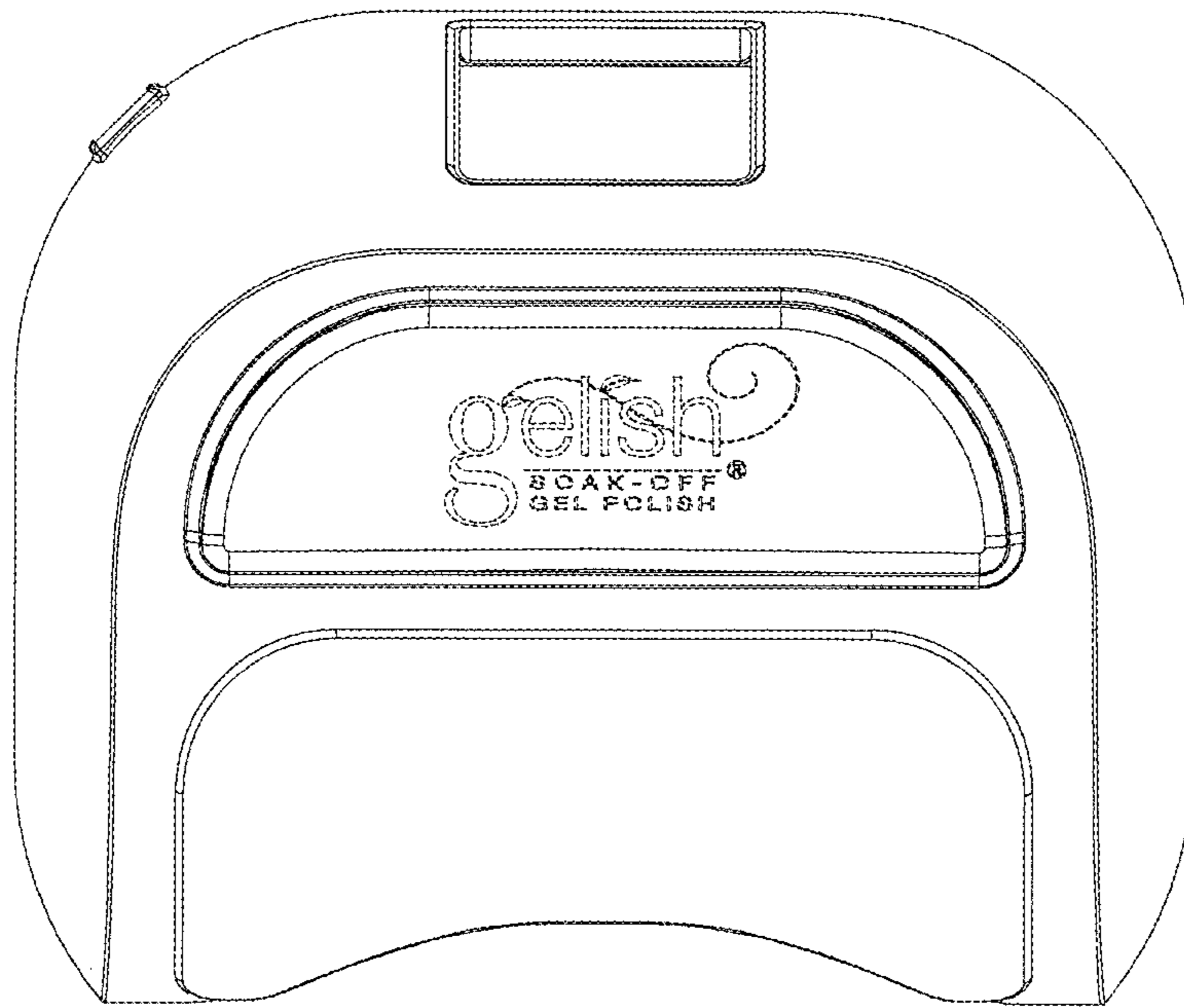

Fig.6

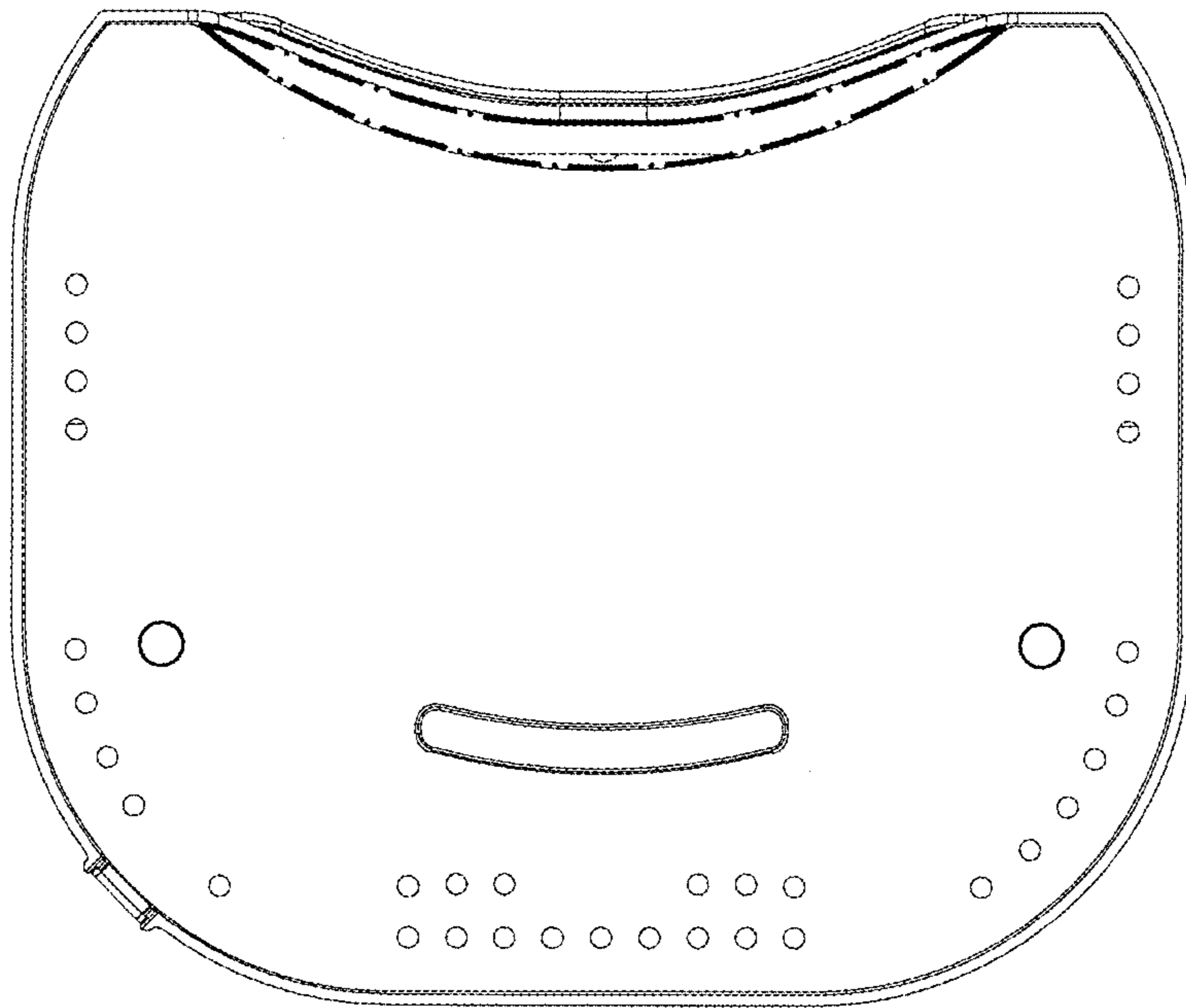

Fig.7

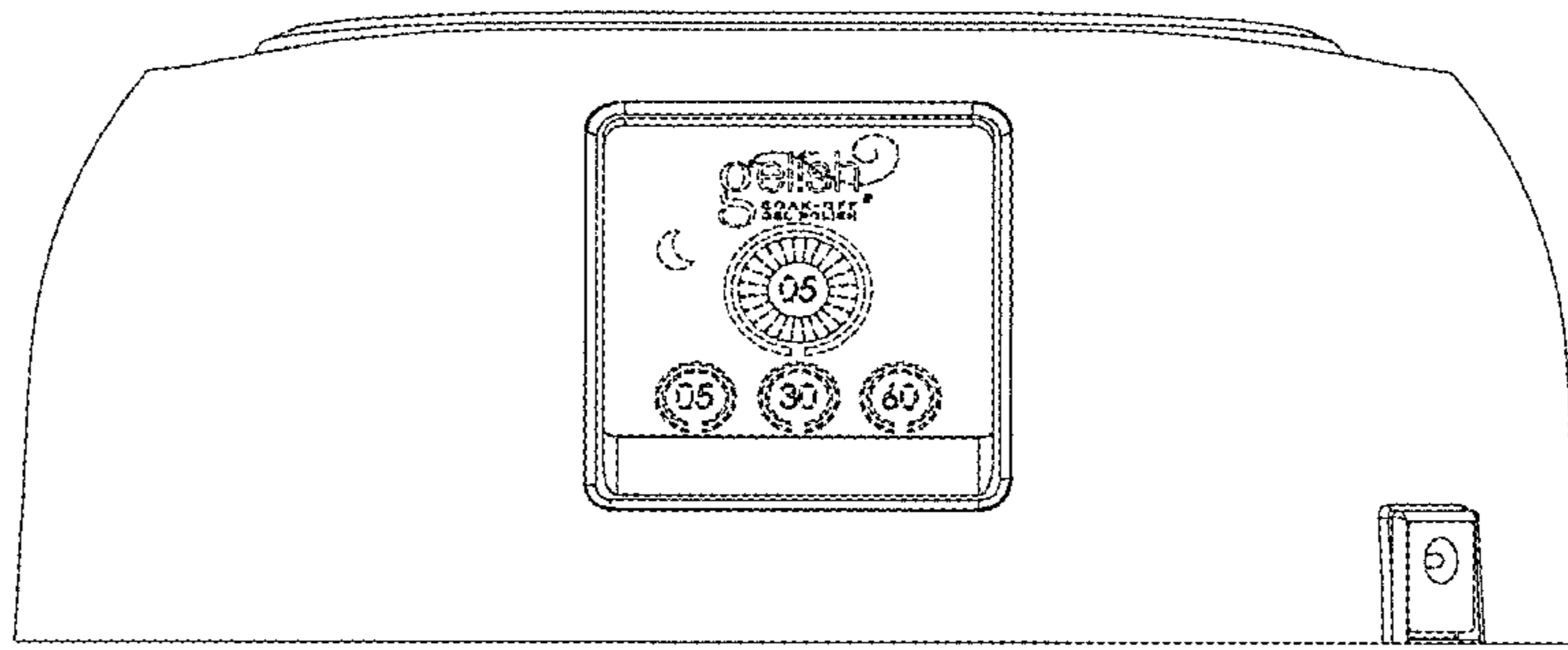

Fig.8