



US00D875303S

(12) **United States Design Patent** (10) **Patent No.:** **US D875,303 S**  
**Pan** (45) **Date of Patent:** **\*\* Feb. 11, 2020**

(54) **ELECTRONIC CIGARETTE**

**DESCRIPTION**

(71) Applicant: **SHENZHEN SMOORE TECHNOLOGY LIMITED**, Shenzhen, Guangdong (CN)  
(72) Inventor: **Weidong Pan**, Guangdong (CN)  
(73) Assignee: **SHENZHEN SMOORE TECHNOLOGY LIMITED**, Shenzhen (CN)  
(\*\*) Term: **15 Years**

(21) Appl. No.: **29/647,836**

(22) Filed: **May 16, 2018**

(30) **Foreign Application Priority Data**

Nov. 24, 2017 (CN) ..... 2017 3 0586607

(51) **LOC (12) Cl.** ..... **27-02**

(52) **U.S. Cl.**  
USPC ..... **D27/162**

(58) **Field of Classification Search**  
USPC ..... D27/100, 101, 162-196; D23/366; D24/110; D19/101, 106, 115, 165, 195  
(Continued)

(56) **References Cited**

**U.S. PATENT DOCUMENTS**

D446,499 S \* 8/2001 Andre ..... D13/110  
D532,927 S \* 11/2006 Sann ..... D27/101  
(Continued)

*Primary Examiner* — Marissa J Cash

(74) *Attorney, Agent, or Firm* — Ladas & Parry LLP

(57) **CLAIM**

The ornamental design for an electronic cigarette, as shown and described.

FIG. 1 is a front elevational view of the first component removed from the electronic cigarette shown in FIG. 17, for clarity of disclosure;  
FIG. 2 is a rear, left, and bottom perspective view thereof;  
FIG. 3 is a front elevational view thereof;  
FIG. 4 is a rear elevational view thereof;  
FIG. 5 is a left side elevational view thereof;  
FIG. 6 is a right side elevational view thereof;  
FIG. 7 is a top plan view thereof;  
FIG. 8 is a bottom plan view thereof.  
FIG. 9 is a front elevational view of the second component removed from the electronic cigarette shown in FIG. 17, for clarity of disclosure;  
FIG. 10 is a rear, left, and bottom perspective view thereof;  
FIG. 11 is a front elevational view thereof;  
FIG. 12 is a rear elevational view thereof;  
FIG. 13 is a left side elevational view thereof;  
FIG. 14 is a right side elevational view thereof;  
FIG. 15 is a top plan view thereof;  
FIG. 16 is a bottom plan view thereof.  
FIG. 17 is a front elevational view of the electronic cigarette shown in an assembled configuration of use where the two components shown in FIGS. 1 & 9 are combined;  
FIG. 18 is a rear, left, and bottom perspective view thereof;  
FIG. 19 is a front elevational view thereof;  
FIG. 20 is a rear elevational view thereof;  
FIG. 21 is a left side elevational view thereof;  
FIG. 22 is a right side elevational view thereof;  
FIG. 23 is a top plan view thereof; and,  
FIG. 24 is a bottom plan view thereof.  
The broken lines in the figures are included for the purpose of illustrating portions of the article which form no part of the claimed design.

**1 Claim, 24 Drawing Sheets**

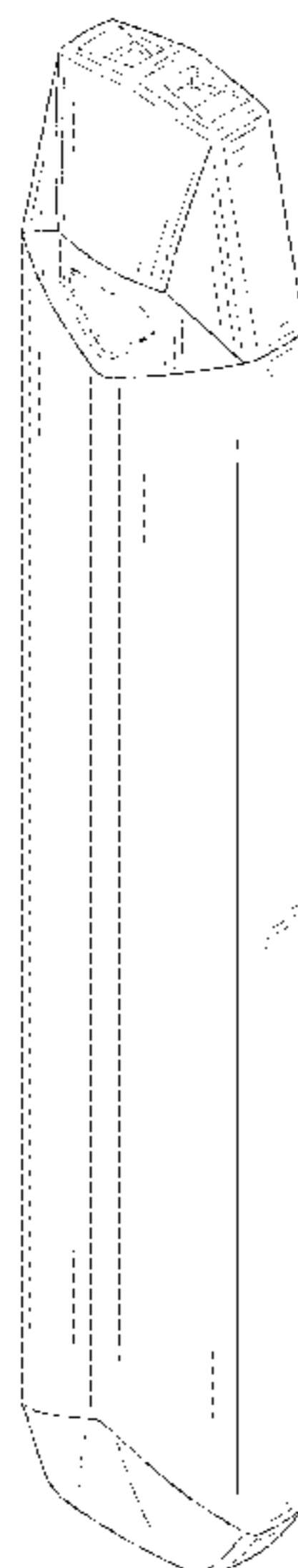

(58) **Field of Classification Search**  
 CPC ..... A24F 47/00; A24F 47/002; A24F 15/12;  
 A24F 1/32  
 See application file for complete search history.

(56) **References Cited**

U.S. PATENT DOCUMENTS

D665,734 S \* 8/2012 Fitch ..... D13/107  
 D716,729 S \* 11/2014 Kelly ..... D13/110  
 D757,352 S \* 5/2016 Bagai ..... D27/101  
 D762,003 S \* 7/2016 Lomeli ..... D27/163  
 D773,116 S \* 11/2016 Liu ..... D27/167  
 D775,762 S \* 1/2017 Chen ..... D27/101  
 D776,338 S \* 1/2017 Lomeli ..... D27/163  
 D776,867 S \* 1/2017 Rado ..... D27/162  
 D776,869 S \* 1/2017 Heidl ..... D27/163  
 D779,719 S \* 2/2017 Qiu ..... D27/101  
 D780,373 S \* 2/2017 Bennett ..... D27/186  
 D786,497 S \* 5/2017 Sudlow ..... D27/162  
 D788,697 S \* 6/2017 Verleur ..... D13/103  
 D792,643 S \* 7/2017 Wong ..... D27/101  
 D799,110 S \* 10/2017 Qiu ..... D27/101  
 D799,113 S \* 10/2017 Qiu ..... D27/101  
 D799,744 S \* 10/2017 Qiu ..... D27/101  
 D811,003 S \* 2/2018 Folyan ..... D27/101  
 D813,447 S \* 3/2018 Watson ..... D27/162  
 D815,341 S \* 4/2018 Qiu ..... D27/101  
 D818,636 S \* 5/2018 Qiu ..... D27/101  
 D818,638 S \* 5/2018 Wright ..... D27/170  
 D819,263 S \* 5/2018 Zhu ..... D27/101  
 D819,881 S \* 6/2018 Qiu ..... D27/101  
 D821,867 S \* 7/2018 Oligschlaeger ..... D9/422  
 D822,271 S \* 7/2018 Eksouzian ..... D27/101  
 D822,896 S \* 7/2018 Durand ..... D27/101  
 D824,093 S \* 7/2018 Kauss ..... D27/101  
 D824,096 S \* 7/2018 Qiu ..... D27/167  
 D825,099 S \* 8/2018 Wright ..... D27/101  
 D825,102 S \* 8/2018 Bowen ..... D27/167  
 D825,834 S \* 8/2018 Chen ..... D27/101  
 D827,195 S \* 8/2018 Chen ..... D27/101  
 D829,371 S \* 9/2018 Durand ..... D27/101  
 D829,372 S \* 9/2018 Huang ..... D27/101  
 D829,373 S \* 9/2018 Huang ..... D27/101  
 D829,980 S \* 10/2018 Qiu ..... D27/162  
 D832,499 S \* 10/2018 Qiu ..... D27/162

D832,500 S \* 10/2018 Qiu ..... D27/162  
 D833,063 S \* 11/2018 Qiu ..... D27/101  
 D834,246 S \* 11/2018 Qiu ..... D27/162  
 D834,744 S \* 11/2018 Zhu ..... D27/101  
 D835,337 S \* 12/2018 Beer ..... D27/162  
 D836,831 S \* 12/2018 Cividi ..... D27/162  
 D837,446 S \* 1/2019 Durand ..... D27/101  
 D839,745 S \* 2/2019 Rehman ..... D9/529  
 D842,535 S \* 3/2019 Kauss ..... D27/101  
 D842,536 S \* 3/2019 Bowen ..... D27/167  
 D843,644 S \* 3/2019 Qiu ..... D27/101  
 D844,229 S \* 3/2019 Sherwood ..... D27/162  
 D844,235 S \* 3/2019 Cividi ..... D27/167  
 D849,996 S \* 5/2019 Duque ..... D27/194  
 2015/0034104 A1 \* 2/2015 Zhou ..... A24F 47/008  
 131/329  
 2015/0108019 A1 \* 4/2015 Liu ..... A24F 15/12  
 206/267  
 2015/0114410 A1 \* 4/2015 Doster ..... A24F 47/008  
 131/329  
 2015/0237918 A1 \* 8/2015 Liu ..... A24F 47/008  
 131/328  
 2016/0345626 A1 \* 12/2016 Wong ..... A24F 47/008  
 2017/0119044 A1 \* 5/2017 Oligschlaeger ..... A24F 15/00  
 2017/0150755 A1 \* 6/2017 Batista ..... A24F 47/008  
 2017/0181468 A1 \* 6/2017 Bowen ..... A24F 47/004  
 2017/0233114 A1 \* 8/2017 Christensen ..... B65B 3/003  
 141/2  
 2017/0258142 A1 \* 9/2017 Hatton ..... A24F 47/008  
 2017/0259170 A1 \* 9/2017 Bowen ..... A24F 47/008  
 2018/0020738 A1 \* 1/2018 Qiu ..... F22B 1/284  
 131/329  
 2018/0043114 A1 \* 2/2018 Bowen ..... A61M 15/003  
 2018/0098571 A1 \* 4/2018 Watson ..... A24F 47/008  
 2018/0153221 A1 \* 6/2018 Verleur ..... A24F 47/008  
 2018/0213847 A1 \* 8/2018 Reevell ..... A24F 47/008  
 2018/0279674 A1 \* 10/2018 Watson ..... A24F 7/02  
 2018/0279682 A1 \* 10/2018 Guo ..... A24F 47/008  
 2018/0303162 A1 \* 10/2018 Zhang ..... A24F 47/008  
 2018/0310618 A1 \* 11/2018 Watson ..... H05B 1/0227  
 2019/0008208 A1 \* 1/2019 Cirillo ..... A24F 47/008  
 2019/0029319 A1 \* 1/2019 Moorman ..... A24F 47/008  
 2019/0037926 A1 \* 2/2019 Qiu ..... A24F 47/008  
 2019/0053542 A1 \* 2/2019 Chen ..... A24F 47/008  
 2019/0124996 A1 \* 5/2019 Qiu ..... A24F 47/008  
 2019/0159519 A1 \* 5/2019 Bowen ..... A24F 47/008

\* cited by examiner

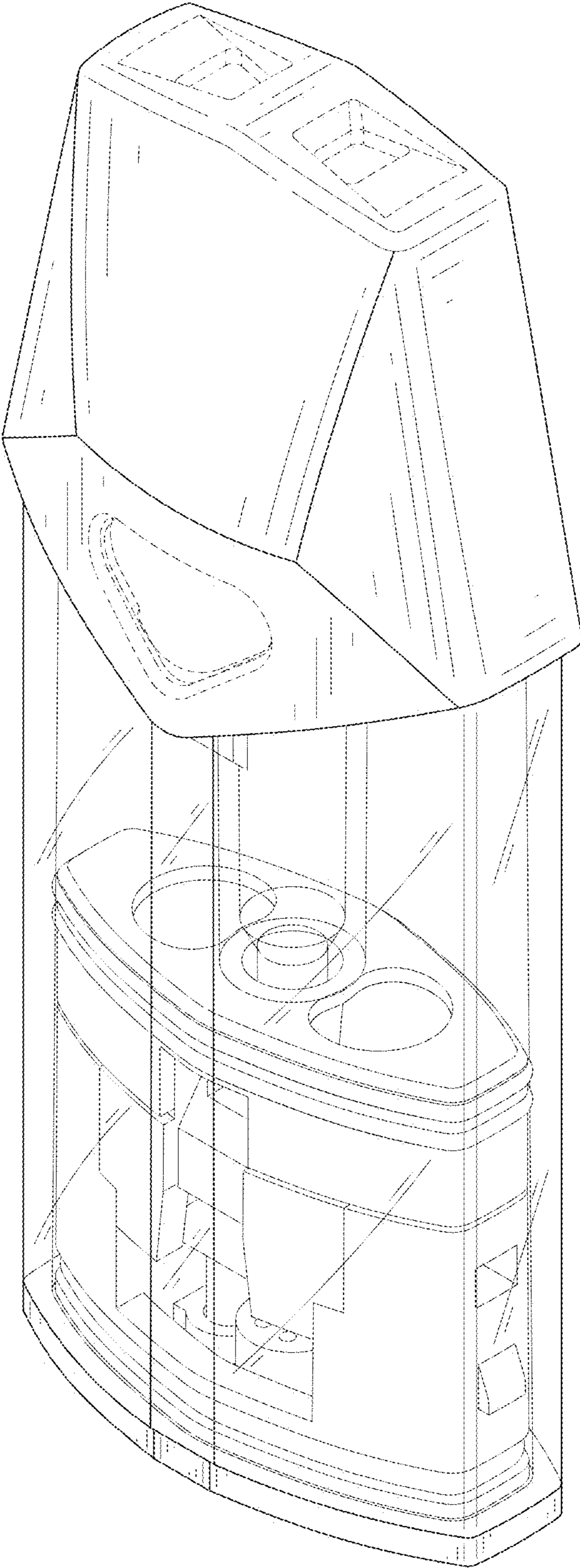

FIG. 1

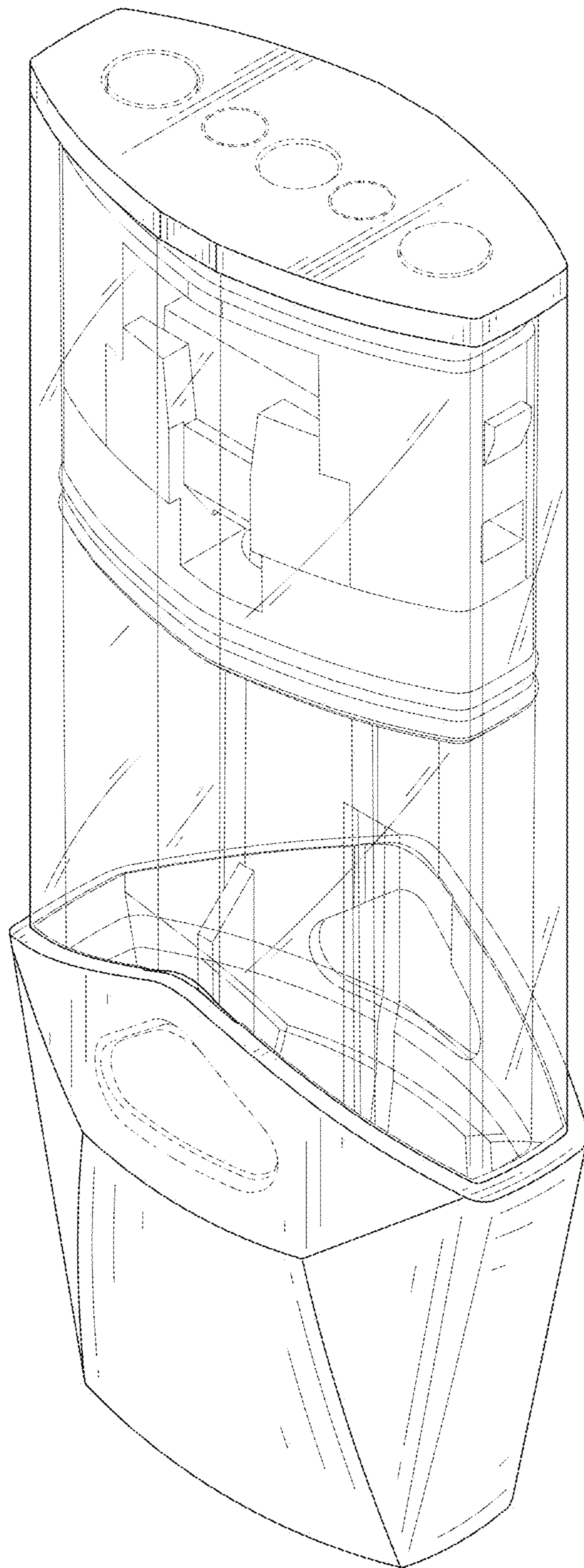

FIG. 2

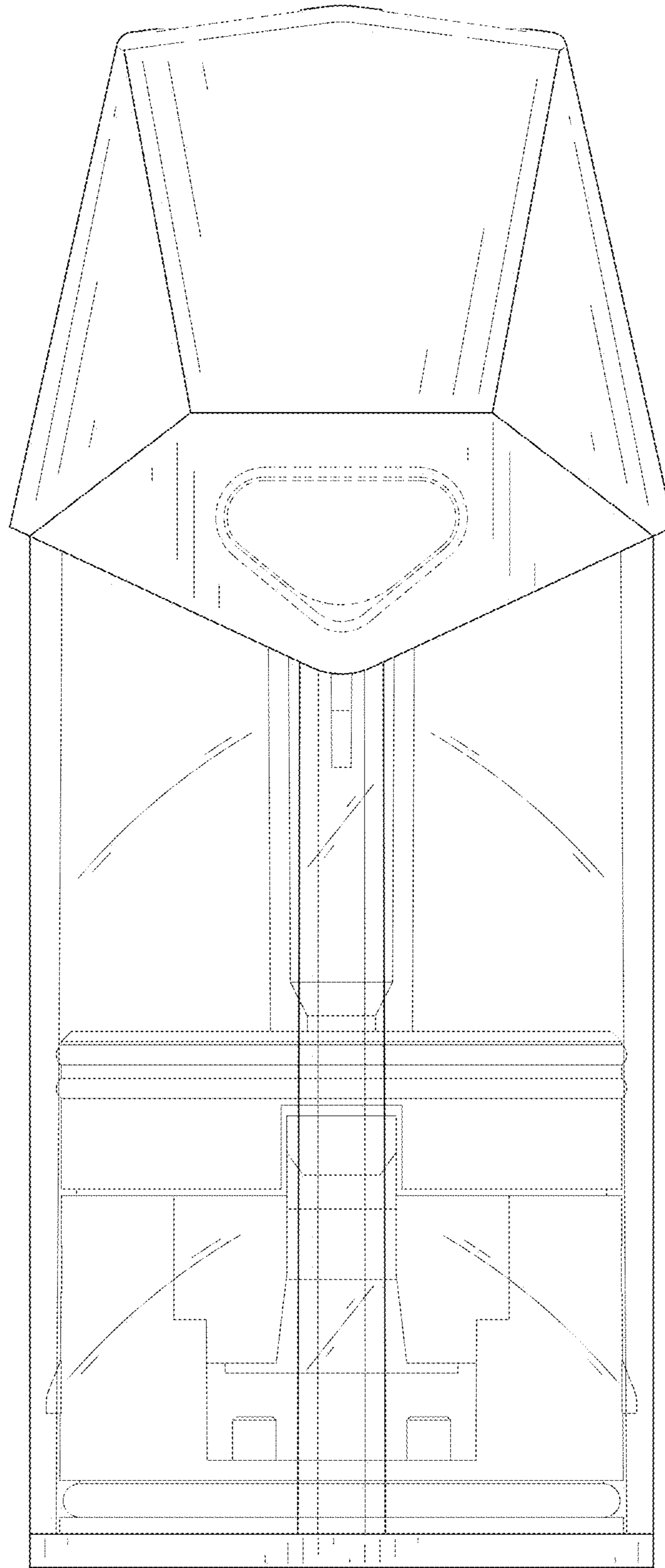

FIG. 3

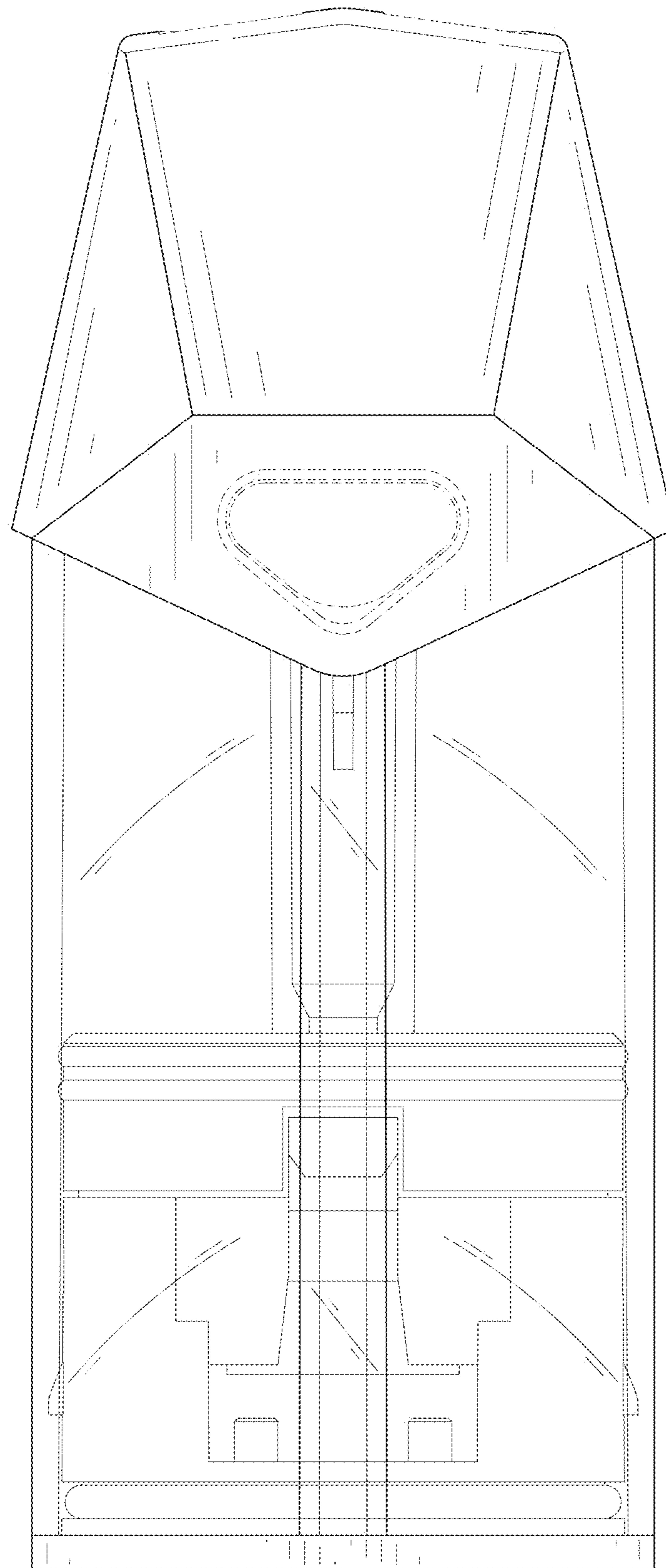

FIG. 4

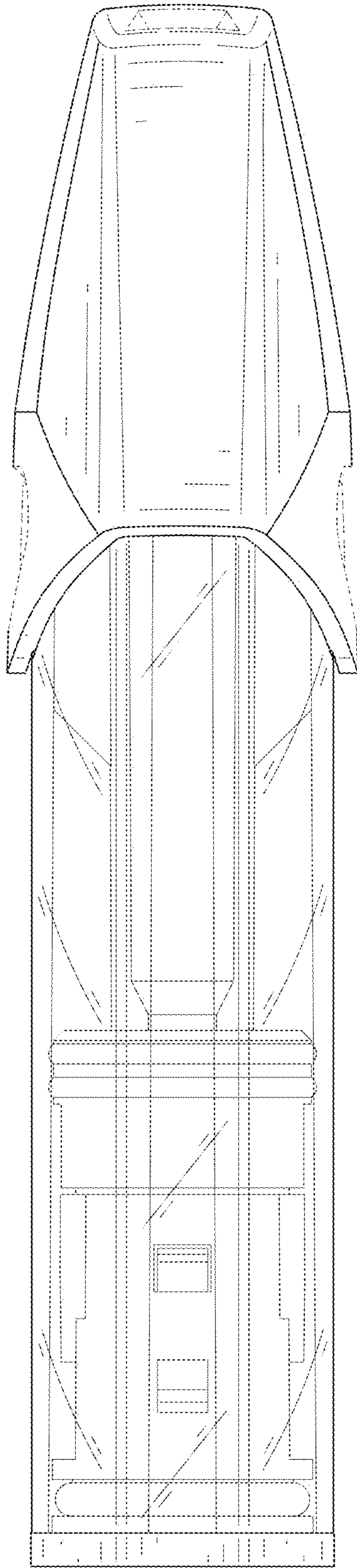

FIG. 5

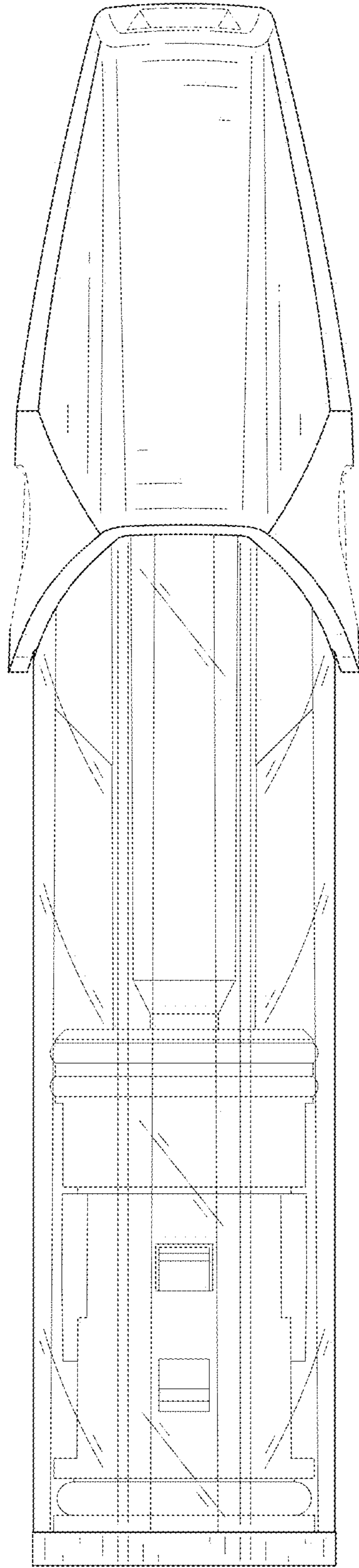

FIG. 6



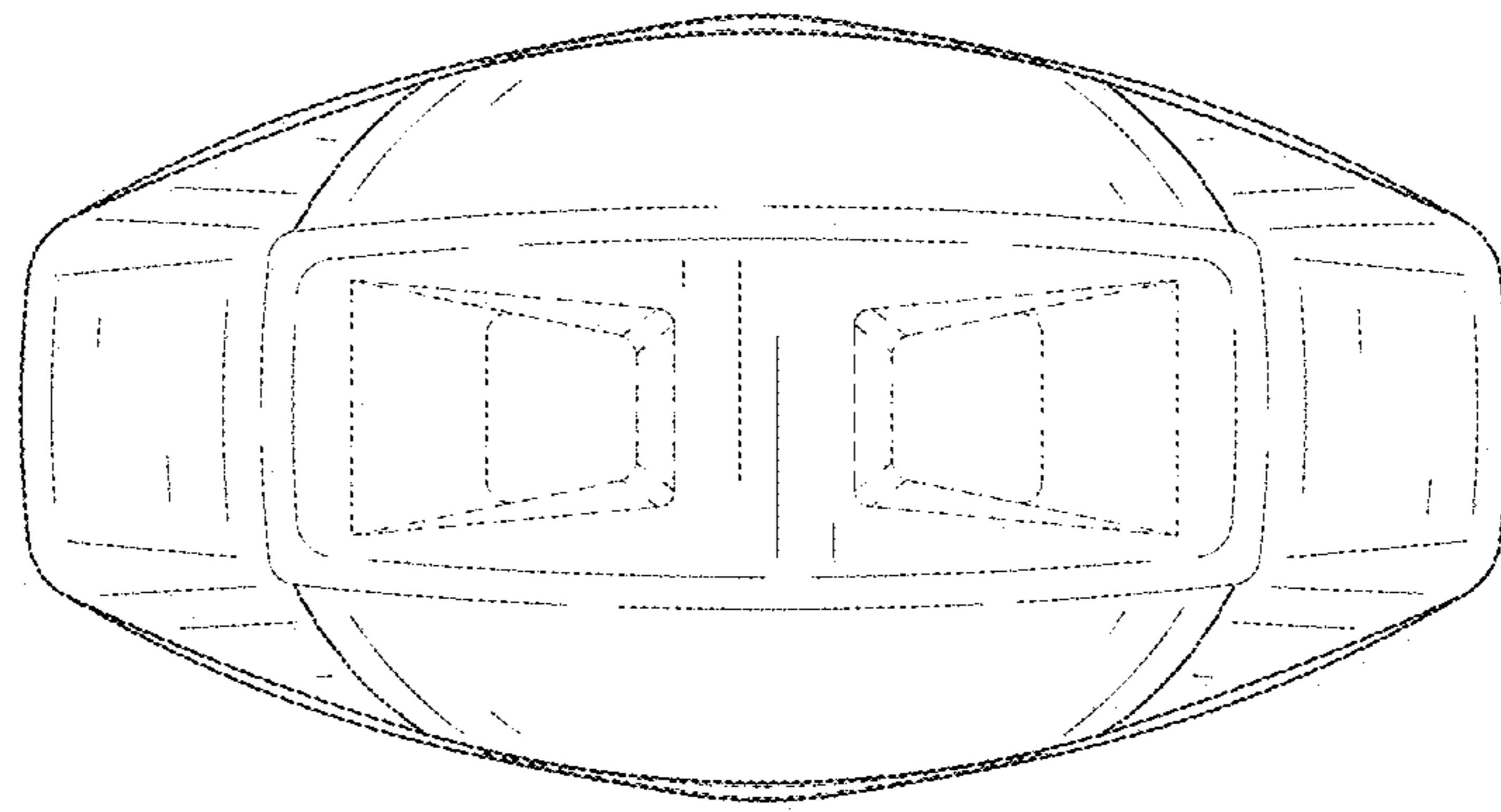

FIG. 7

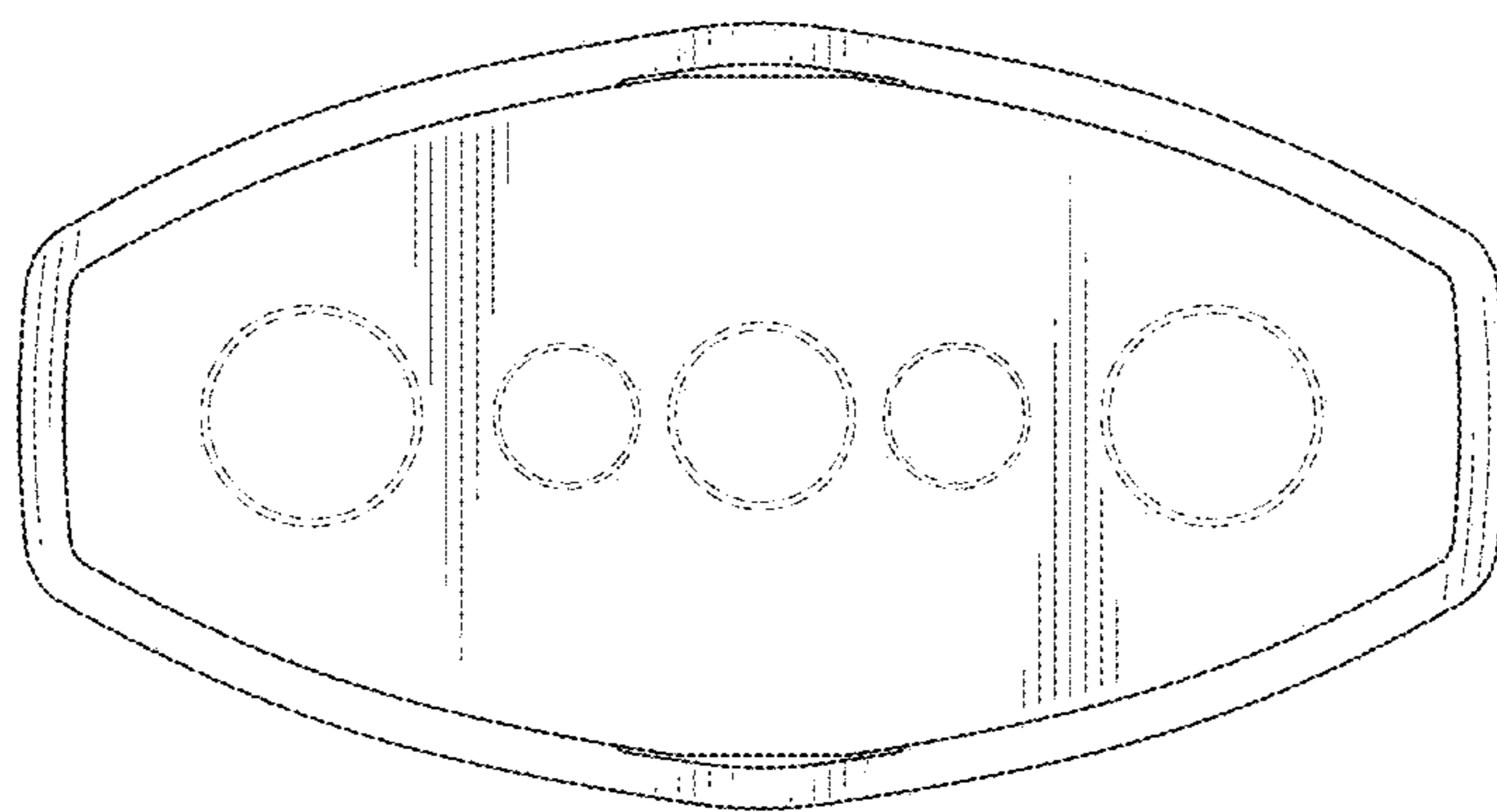

FIG. 8

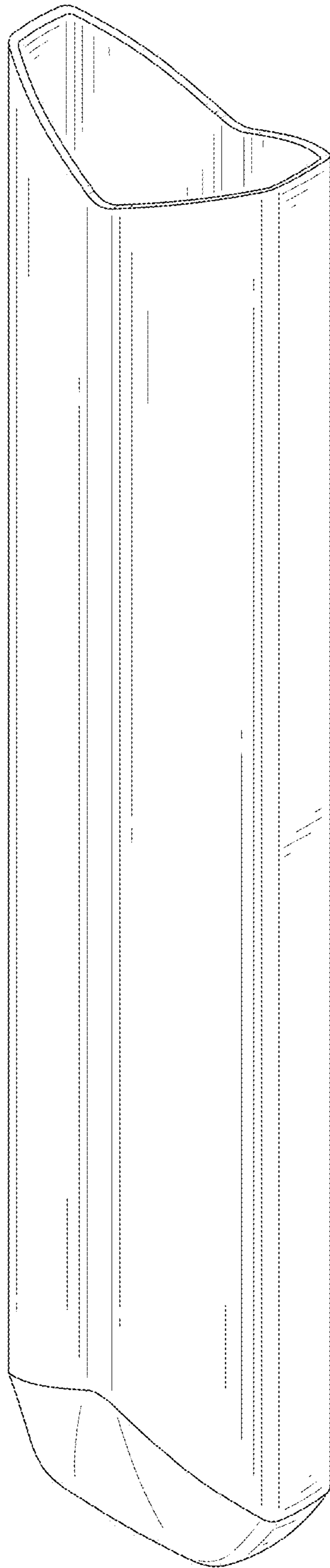

FIG. 9

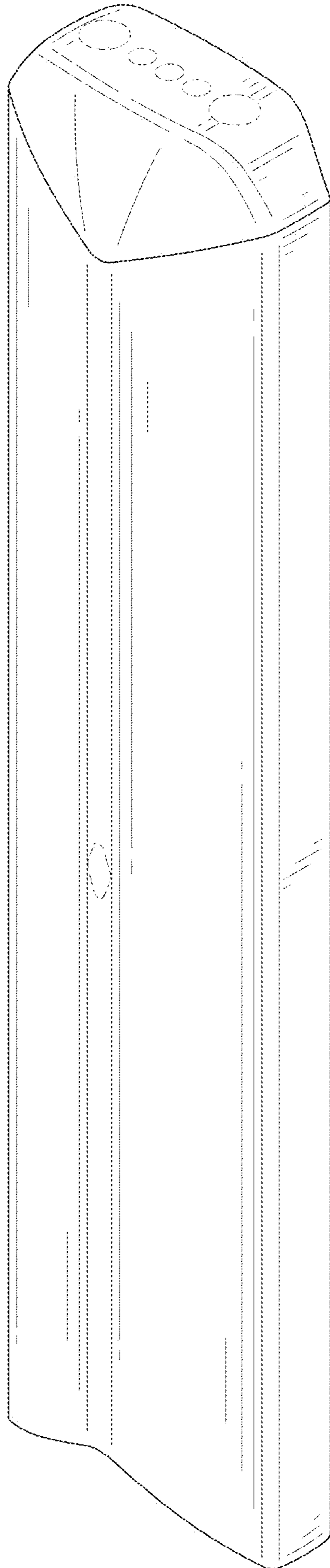

FIG. 10

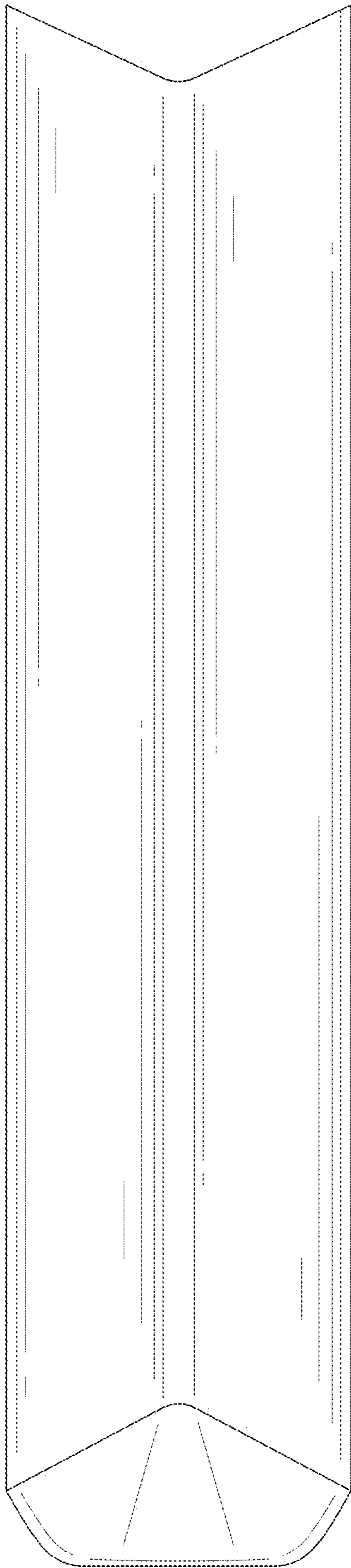

FIG. 11

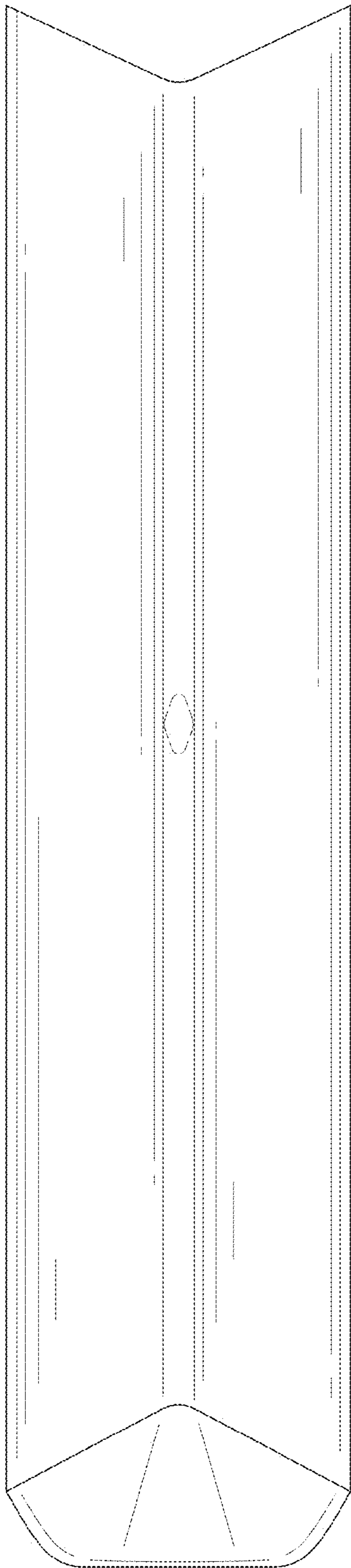

FIG. 12

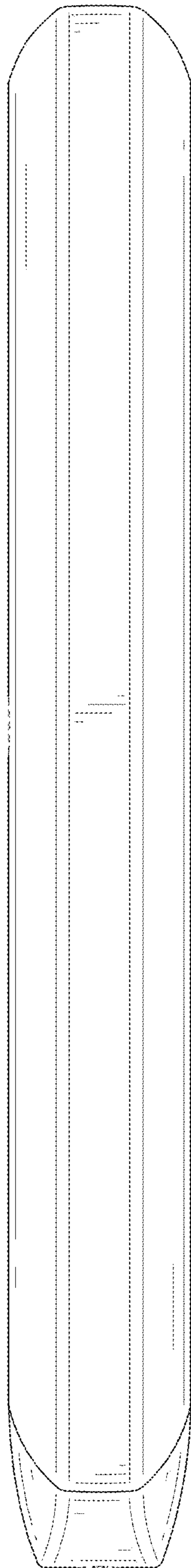

FIG. 13

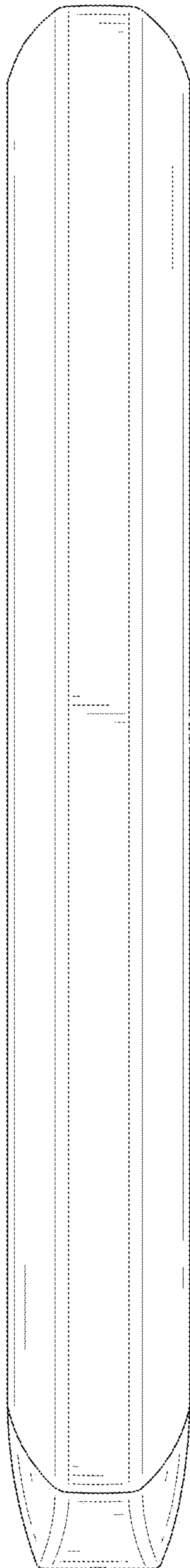

FIG. 14



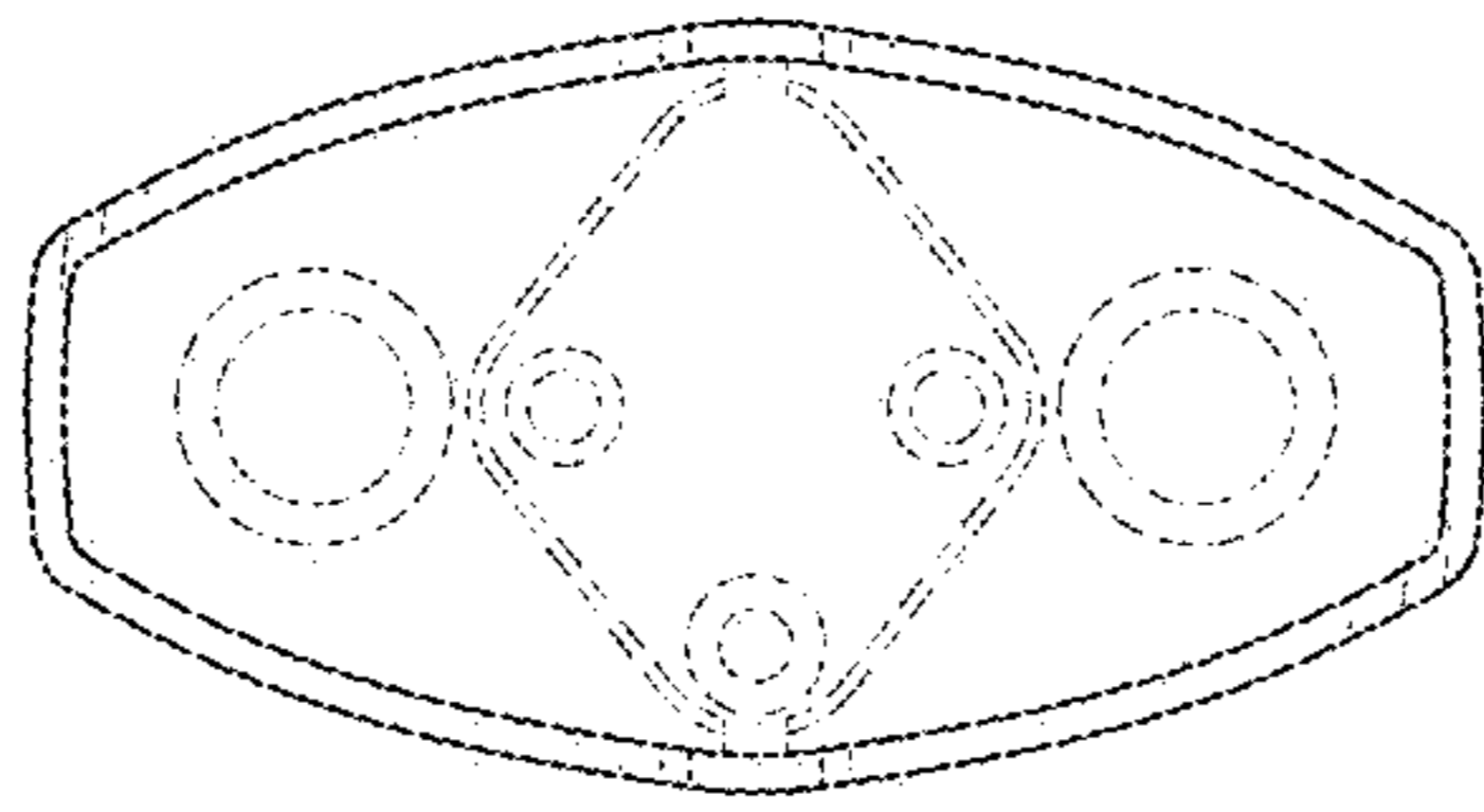

FIG. 15

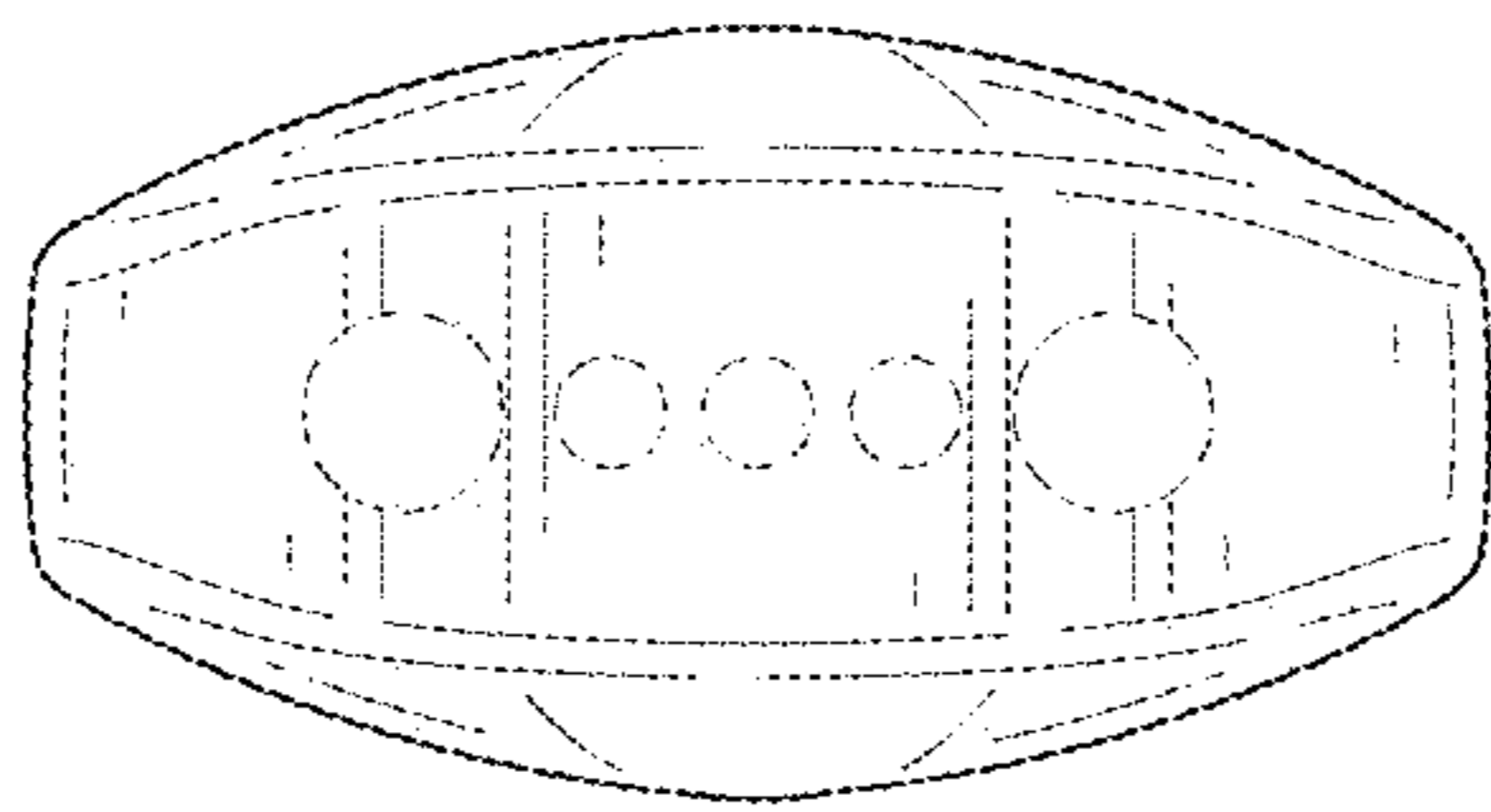

FIG. 16

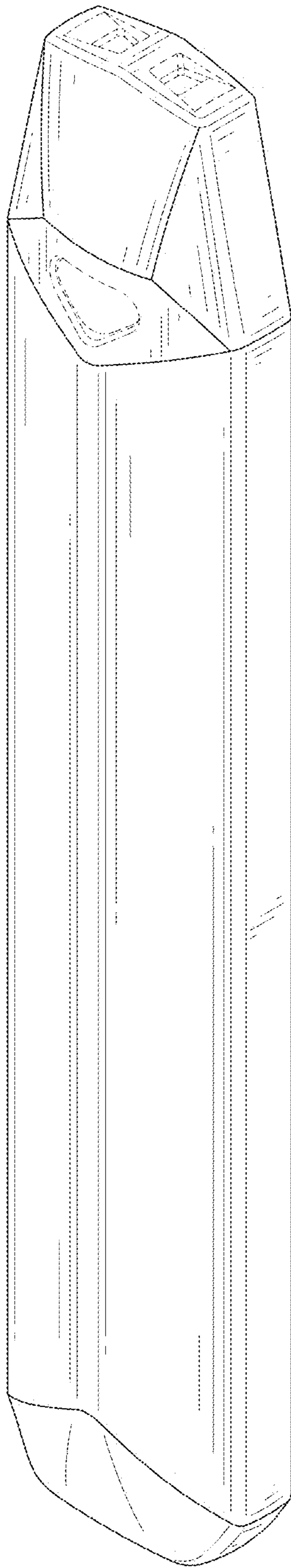

FIG. 17

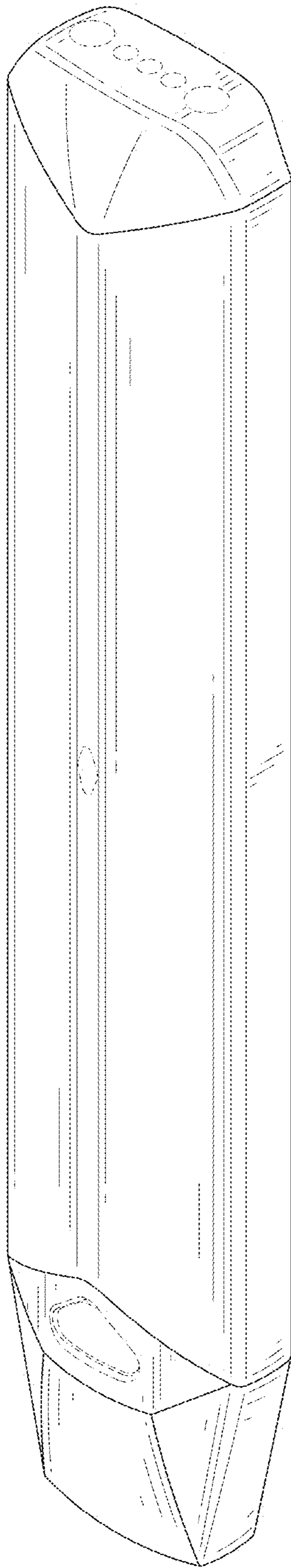

FIG. 18

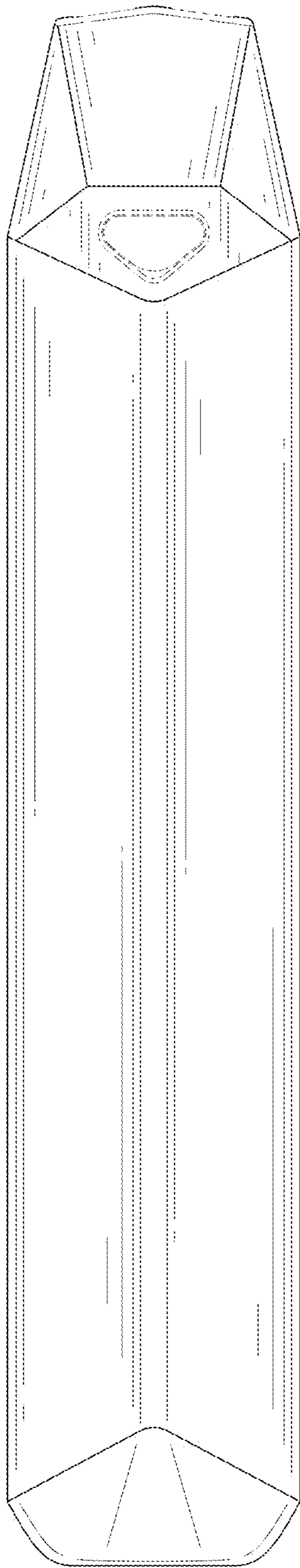

FIG. 19

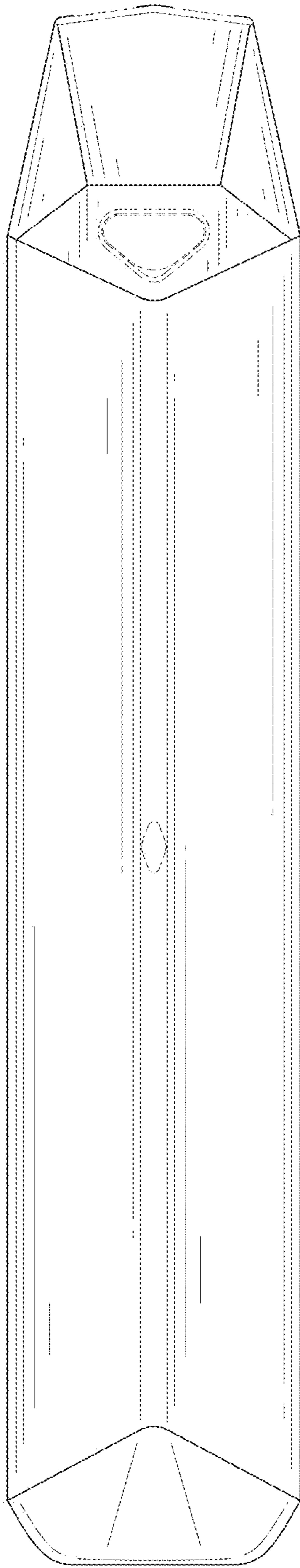

FIG. 20

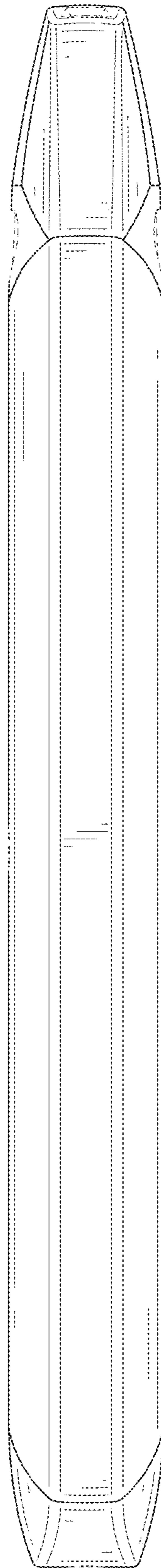

FIG. 21

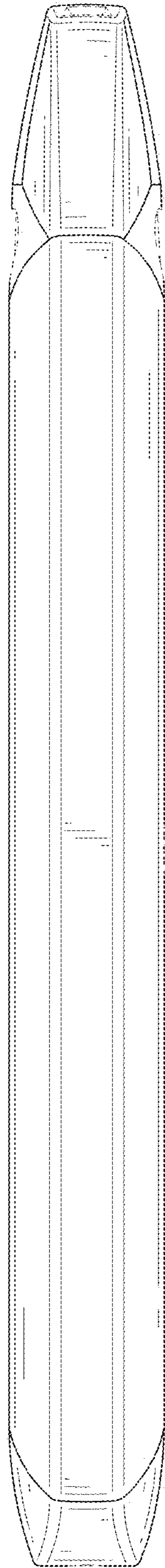

FIG. 22



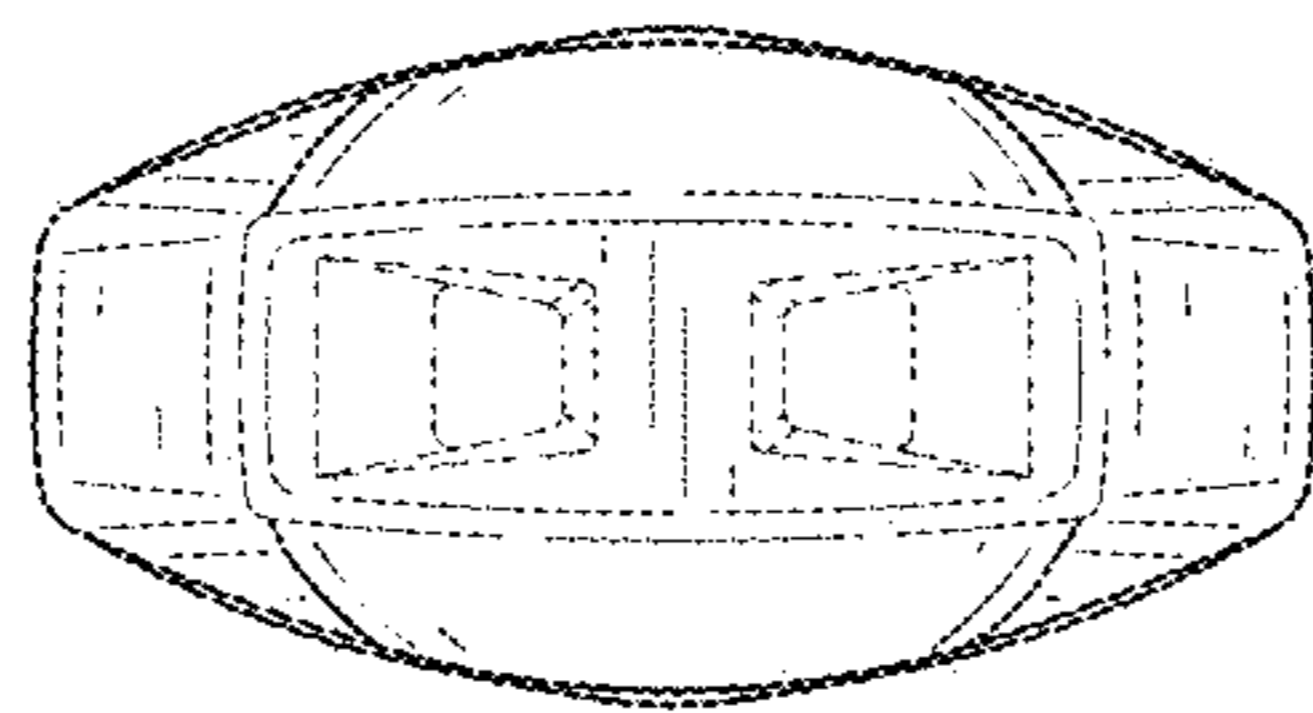

FIG. 23

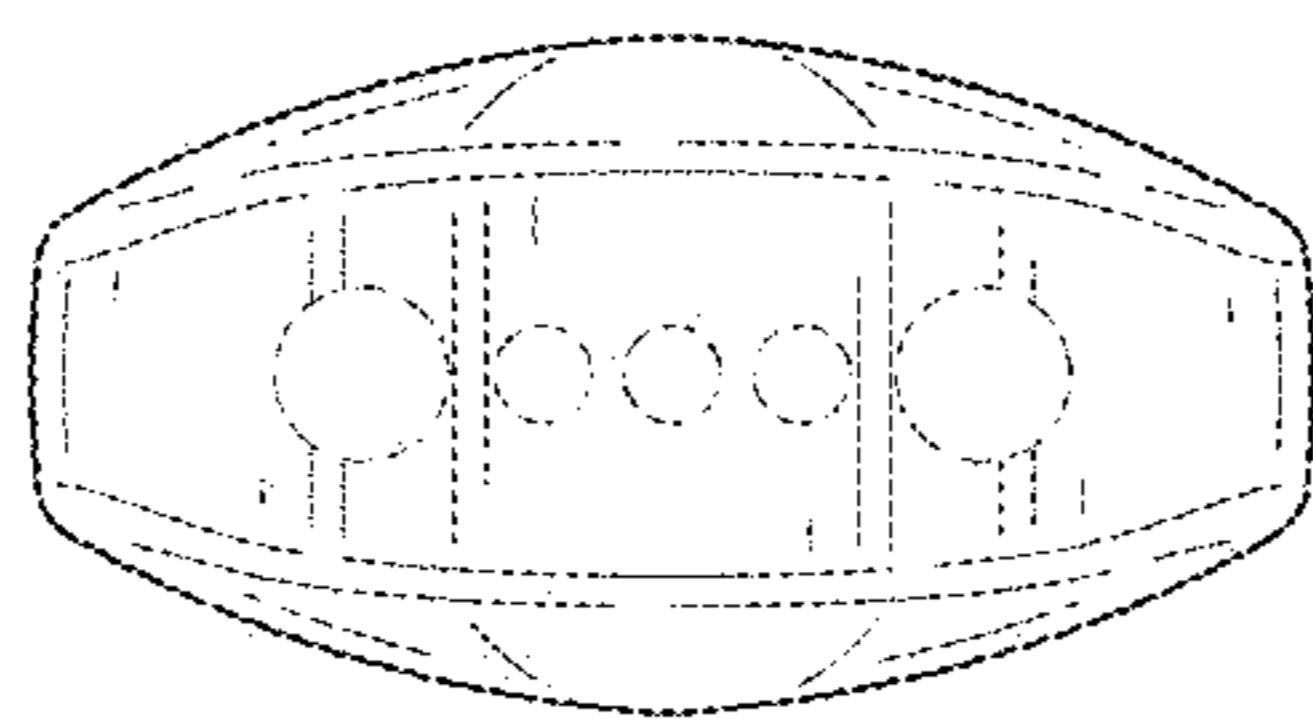

FIG. 24