



US00D875302S

(12) **United States Design Patent** (10) **Patent No.:** **US D875,302 S**  
**Pan** (45) **Date of Patent:** **\*\* Feb. 11, 2020**

(54) **ELECTRONIC CIGARETTE**

(74) *Attorney, Agent, or Firm* — Ladas & Parry LLP

(71) Applicant: **SHENZHEN SMOORE TECHNOLOGY LIMITED**,  
Shenzhen, Guangdong (CN)

(57) **CLAIM**

The ornamental design for an electronic cigarette, as shown and described.

(72) Inventor: **Weidong Pan**, Guangdong (CN)

(73) Assignee: **Shenzhen Smoore Technology Limited**, Shenzhen (CN)

**DESCRIPTION**

(\*\*) Term: **15 Years**

(21) Appl. No.: **29/646,040**

(22) Filed: **May 1, 2018**

(30) **Foreign Application Priority Data**

Dec. 6, 2017 (CN) ..... 2017 3 0617167

(51) **LOC (12) Cl.** ..... **27-02**

(52) **U.S. Cl.**  
USPC ..... **D27/162**

(58) **Field of Classification Search**  
USPC ..... D27/100, 101, 162–196; D23/366;  
D24/110; D19/101, 106, 115, 165, 195  
(Continued)

(56) **References Cited**

**U.S. PATENT DOCUMENTS**

D446,499 S \* 8/2001 Andre ..... D13/110  
D532,927 S \* 11/2006 Sann ..... D27/101  
(Continued)

**OTHER PUBLICATIONS**

MOTI Vape POD Quick Starter Kit by DHgate. dated 2019. found online [Jun. 7, 2019] <https://www.dhgate.com/product/moti-vape-pod-quick-starter-electronic-cigarette/455141540.html>.\*

*Primary Examiner* — Marissa J Cash

FIG. 1 is a front elevational view the first component removed from the electronic cigarette shown in FIG. 17, for clarity of disclosure;  
FIG. 2 is a rear elevational view thereof;  
FIG. 3 is a left side elevational view thereof;  
FIG. 4 is a right side elevational view thereof;  
FIG. 5 is a top plan view thereof;  
FIG. 6 is a bottom plan view thereof;  
FIG. 7 is a front, right, and bottom perspective view thereof; and  
FIG. 8 is a rear, left, and top perspective view thereof.  
FIG. 9 is a front elevational view of the second component removed from the electronic cigarette shown in FIG. 17, for clarity of disclosure;  
FIG. 10 is a rear elevational view thereof;  
FIG. 11 is a left side elevational view thereof;  
FIG. 12 is a right side elevational view thereof;  
FIG. 13 is a top plan view thereof;  
FIG. 14 is a bottom plan view thereof;  
FIG. 15 is a front, right, and bottom perspective view thereof; and  
FIG. 16 is a rear, left, and top perspective view thereof.  
FIG. 17 is a front elevational view of the electronic cigarette shown in an assembled configuration of use where the two components shown in FIGS. 1 & 9 are combined;  
FIG. 18 is a rear elevational view thereof;  
FIG. 19 is a left side elevational view thereof;  
FIG. 20 is a right side elevational view thereof;  
FIG. 21 is a top plan view thereof;  
FIG. 22 is a bottom plan view thereof;  
FIG. 23 is a front, right, and bottom perspective view thereof; and,  
FIG. 24 is a rear, left, and top perspective view thereof.

(Continued)

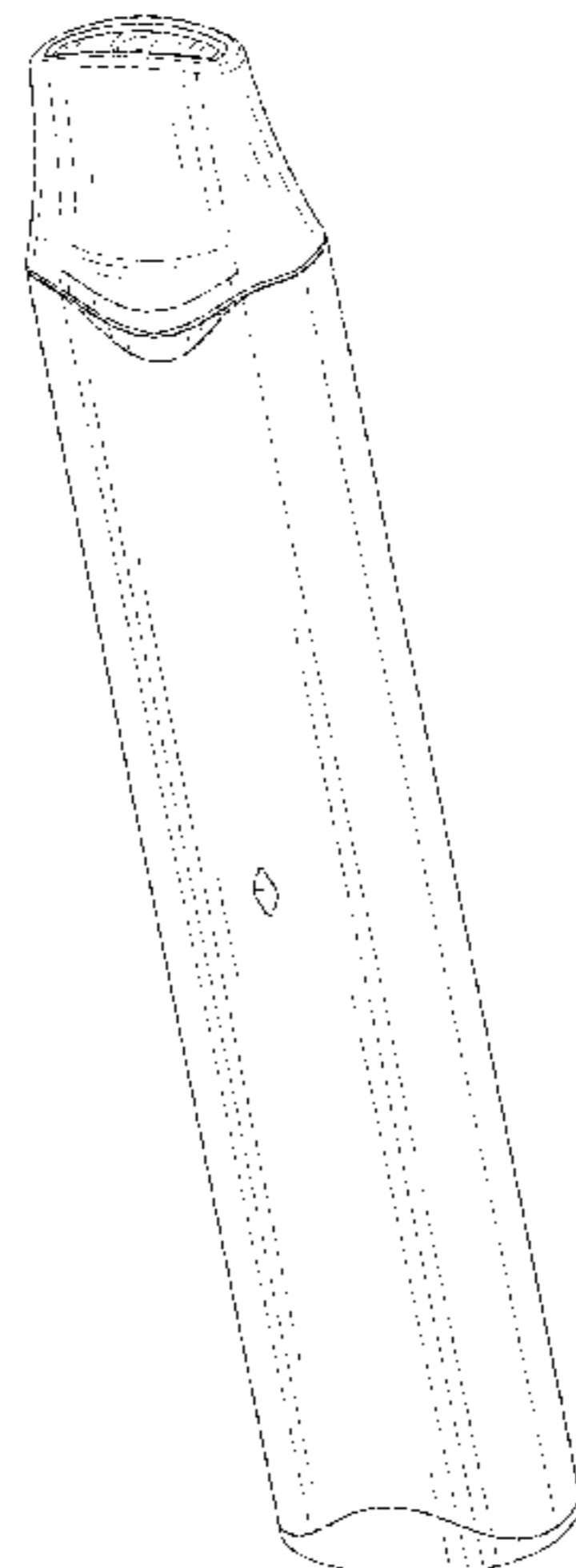

The broken lines in the figures are included for the purpose of illustrating portions of the article which form no part of the claimed design.

**1 Claim, 24 Drawing Sheets**

(58) **Field of Classification Search**

CPC ..... A24F 47/00; A24F 47/002; A24F 15/12;  
A24F 1/32

See application file for complete search history.

(56) **References Cited**

U.S. PATENT DOCUMENTS

D665,734 S \* 8/2012 Fitch ..... D13/107  
D716,729 S \* 11/2014 Kelly ..... D13/110  
D757,352 S \* 5/2016 Bagai ..... D27/101  
D762,003 S \* 7/2016 Lomeli ..... D27/163  
D773,116 S \* 11/2016 Liu ..... D27/167  
D775,762 S \* 1/2017 Chen ..... D27/101  
D776,338 S \* 1/2017 Lomeli ..... D27/163  
D776,867 S \* 1/2017 Rado ..... D27/162  
D776,869 S \* 1/2017 Heidl ..... D27/163  
D779,719 S \* 2/2017 Qiu ..... D27/101  
D780,373 S \* 2/2017 Bennett ..... D27/186  
D786,497 S \* 5/2017 Sudlow ..... D27/162  
D788,697 S \* 6/2017 Verleur ..... D13/103  
D792,643 S \* 7/2017 Wong ..... D27/101  
D799,110 S \* 10/2017 Qiu ..... D27/101  
D799,113 S \* 10/2017 Qiu ..... D27/101  
D799,744 S \* 10/2017 Qiu ..... D27/101  
D811,003 S \* 2/2018 Folyan ..... D27/101  
D813,447 S \* 3/2018 Watson ..... D27/162  
D815,341 S \* 4/2018 Qiu ..... D27/101  
D818,636 S \* 5/2018 Qiu ..... D27/101  
D818,638 S \* 5/2018 Wright ..... D27/170  
D819,263 S \* 5/2018 Zhu ..... D27/101  
D819,881 S \* 6/2018 Qiu ..... D27/101  
D821,867 S \* 7/2018 Oligschlaeger ..... D9/422  
D822,271 S \* 7/2018 Eksouzian ..... D27/101  
D822,896 S \* 7/2018 Durand ..... D27/101  
D824,093 S \* 7/2018 Kauss ..... D27/101  
D824,096 S \* 7/2018 Qiu ..... D27/167  
D825,099 S \* 8/2018 Wright ..... D27/101  
D825,102 S \* 8/2018 Bowen ..... D27/167  
D825,834 S \* 8/2018 Chen ..... D27/101  
D827,195 S \* 8/2018 Chen ..... D27/101  
D829,371 S \* 9/2018 Durand ..... D27/101

D829,372 S \* 9/2018 Huang ..... D27/101  
D829,373 S \* 9/2018 Huang ..... D27/101  
D829,980 S \* 10/2018 Qiu ..... D27/162  
D832,499 S \* 10/2018 Qiu ..... D27/162  
D832,500 S \* 10/2018 Qiu ..... D27/162  
D833,063 S \* 11/2018 Qiu ..... D27/101  
D834,246 S \* 11/2018 Qiu ..... D27/162  
D834,744 S \* 11/2018 Zhu ..... D27/101  
D835,337 S \* 12/2018 Beer ..... D27/162  
D836,831 S \* 12/2018 Cividi ..... D27/162  
D837,446 S \* 1/2019 Durand ..... D27/101  
D839,745 S \* 2/2019 Rehman ..... D9/529  
D842,535 S \* 3/2019 Kauss ..... D27/101  
D842,536 S \* 3/2019 Bowen ..... D27/167  
D843,644 S \* 3/2019 Qiu ..... D27/101  
D844,229 S \* 3/2019 Sherwood ..... D27/162  
D844,235 S \* 3/2019 Cividi ..... D27/167  
D849,996 S \* 5/2019 Duque ..... D27/194  
2015/0034104 A1 \* 2/2015 Zhou ..... A24F 47/008  
131/329  
2015/0108019 A1 \* 4/2015 Liu ..... A24F 15/12  
206/267  
2015/0114410 A1 \* 4/2015 Doster ..... A24F 47/008  
131/329  
2015/0237918 A1 \* 8/2015 Liu ..... A24F 47/008  
131/328  
2016/0345626 A1 \* 12/2016 Wong ..... A24F 47/008  
2017/0119044 A1 \* 5/2017 Oligschlaeger ..... A24F 15/00  
2017/0150755 A1 \* 6/2017 Batista ..... A24F 47/008  
2017/0181468 A1 \* 6/2017 Bowen ..... A24F 47/004  
2017/0233114 A1 \* 8/2017 Christensen ..... B65B 3/003  
141/2  
2017/0258142 A1 \* 9/2017 Hatton ..... A24F 47/008  
2017/0259170 A1 \* 9/2017 Bowen ..... A24F 47/008  
2018/0020738 A1 \* 1/2018 Qiu ..... F22B 1/284  
131/329  
2018/0043114 A1 \* 2/2018 Bowen ..... A61M 15/003  
2018/0098571 A1 \* 4/2018 Watson ..... A24F 47/008  
2018/0153221 A1 \* 6/2018 Verleur ..... A24F 47/008  
2018/0213847 A1 \* 8/2018 Reeve ..... A24F 47/008  
2018/0279674 A1 \* 10/2018 Watson ..... A24F 7/02  
2018/0279682 A1 \* 10/2018 Guo ..... A24F 47/008  
2018/0303162 A1 \* 10/2018 Zhang ..... A24F 47/008  
2018/0310618 A1 \* 11/2018 Watson ..... H05B 1/0227  
2019/0008208 A1 \* 1/2019 Cirillo ..... A24F 47/008  
2019/0029319 A1 \* 1/2019 Moorman ..... A24F 47/008  
2019/0037926 A1 \* 2/2019 Qiu ..... A24F 47/008  
2019/0053542 A1 \* 2/2019 Chen ..... A24F 47/008  
2019/0124996 A1 \* 5/2019 Qiu ..... A24F 47/008  
2019/0159519 A1 \* 5/2019 Bowen ..... A24F 47/008

\* cited by examiner

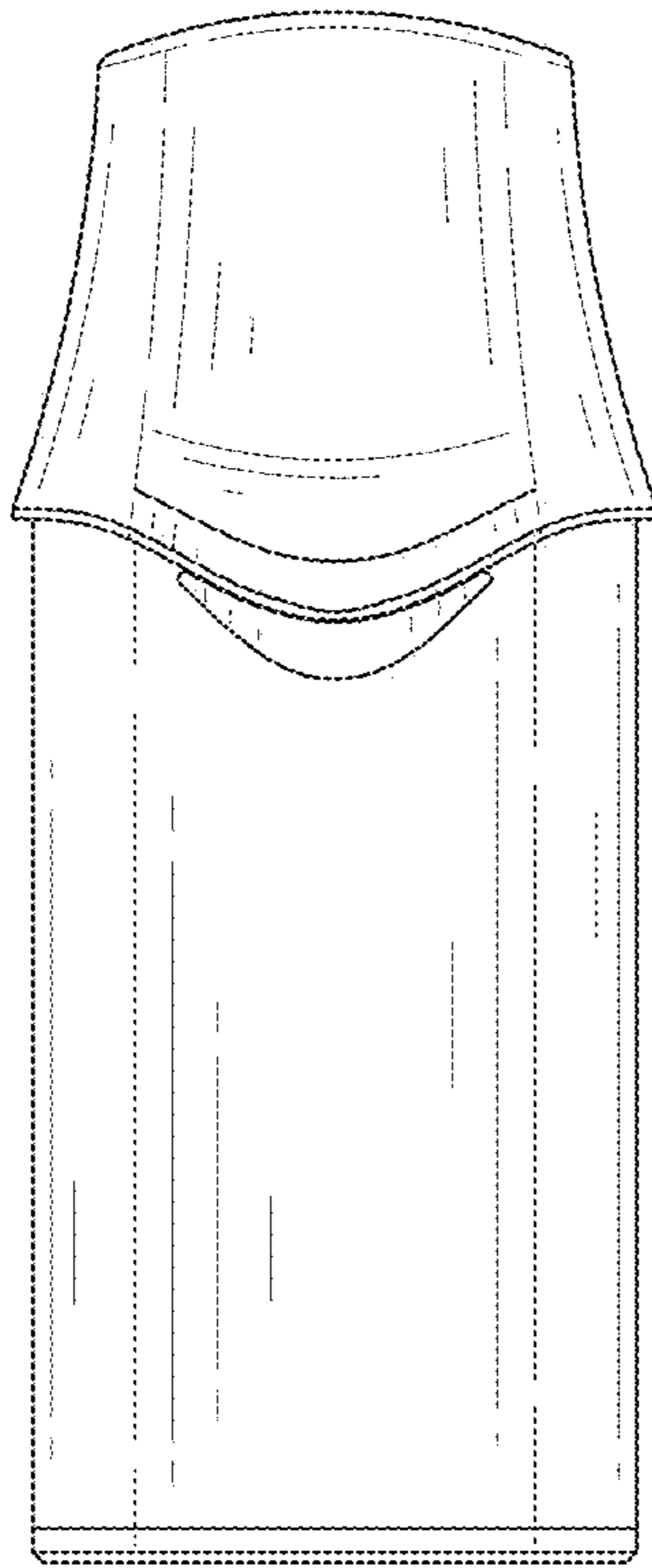

FIG. 1

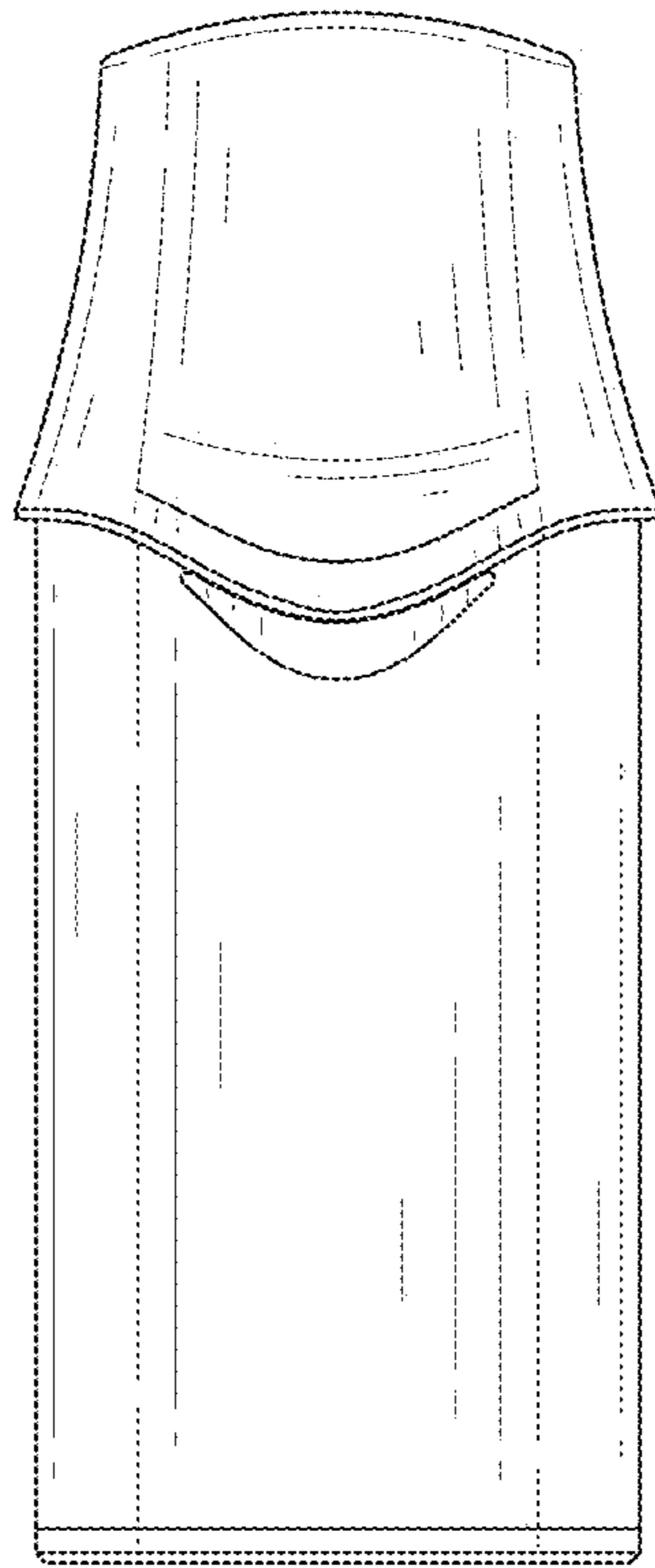

FIG. 2



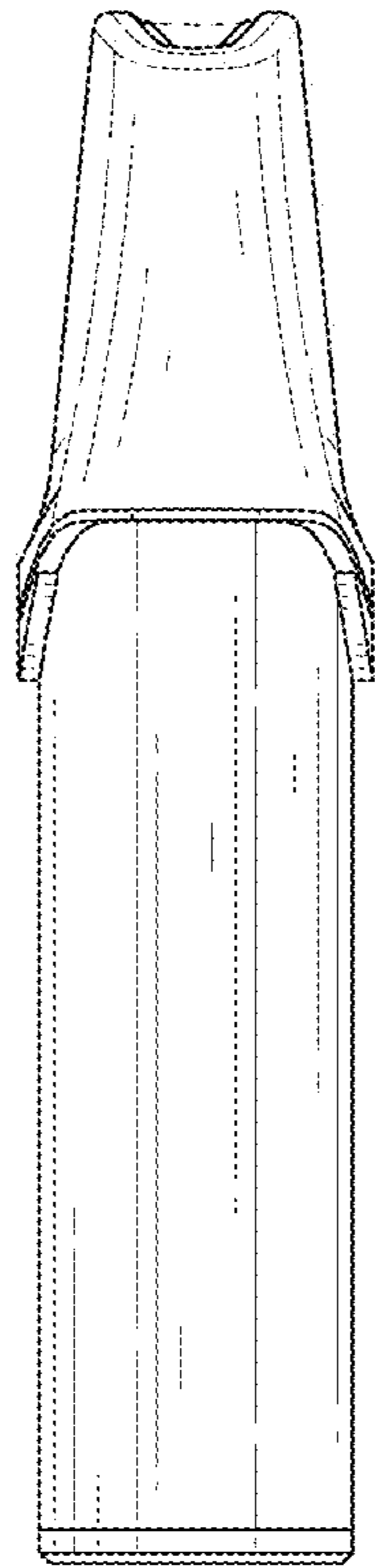

FIG. 3

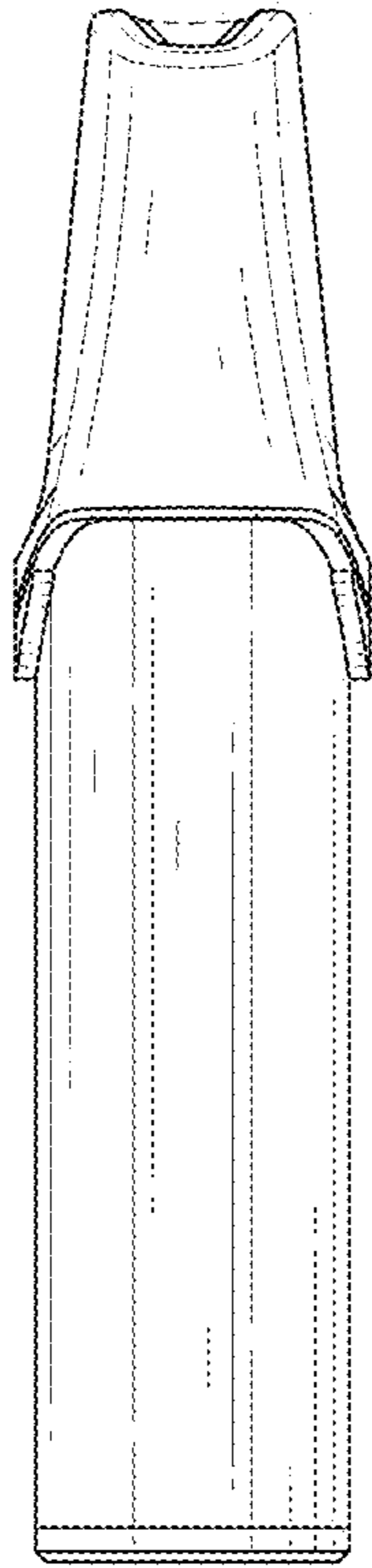

FIG. 4

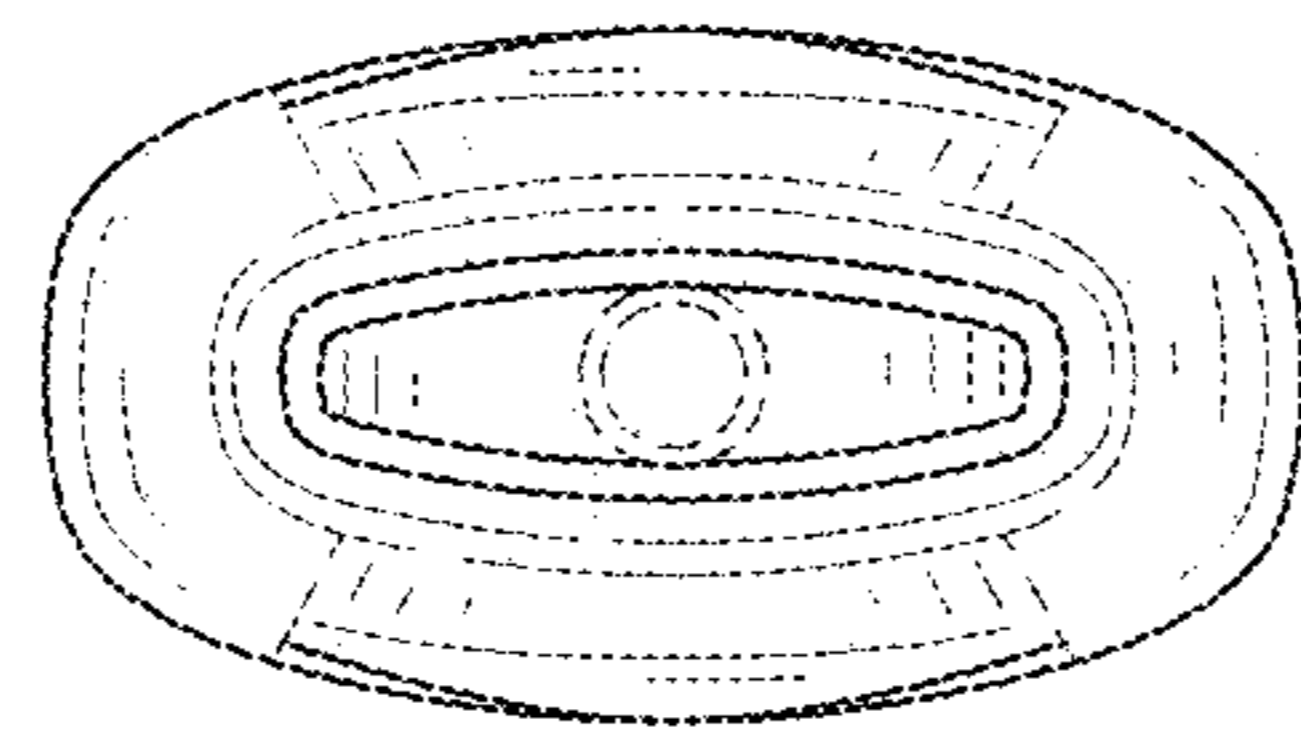

FIG. 5

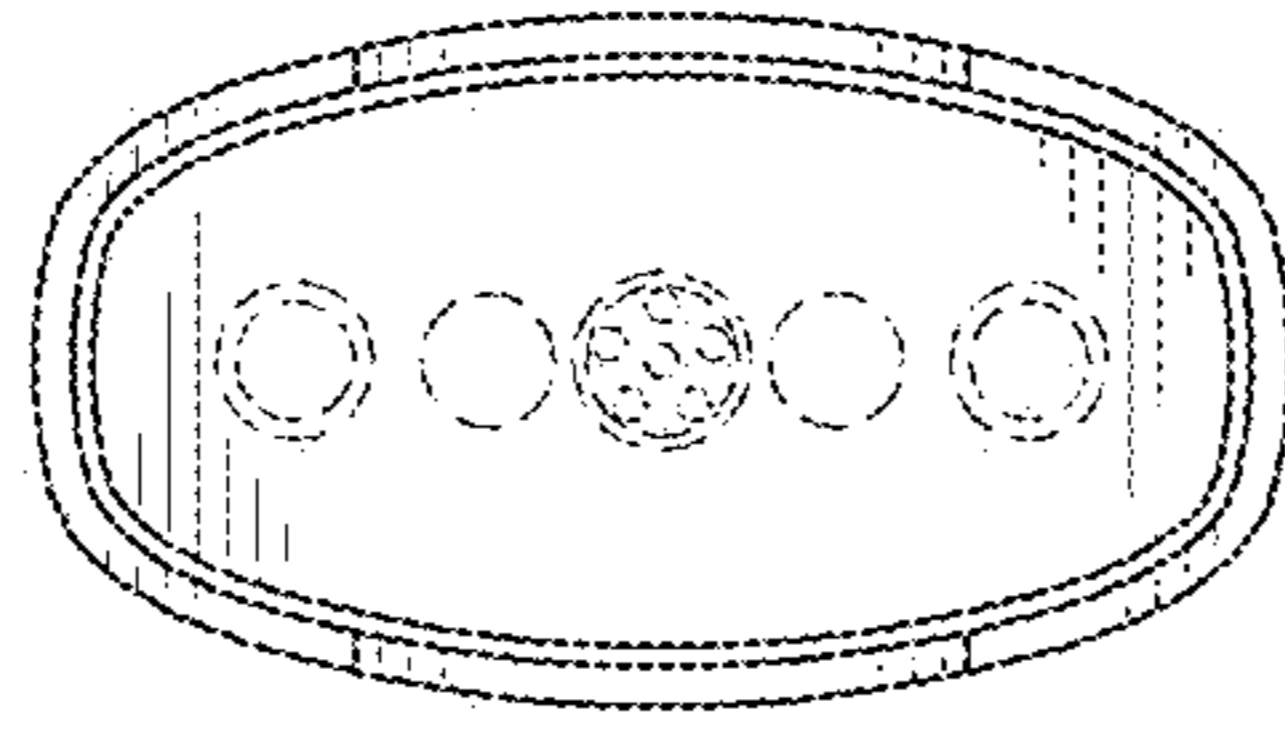

FIG. 6



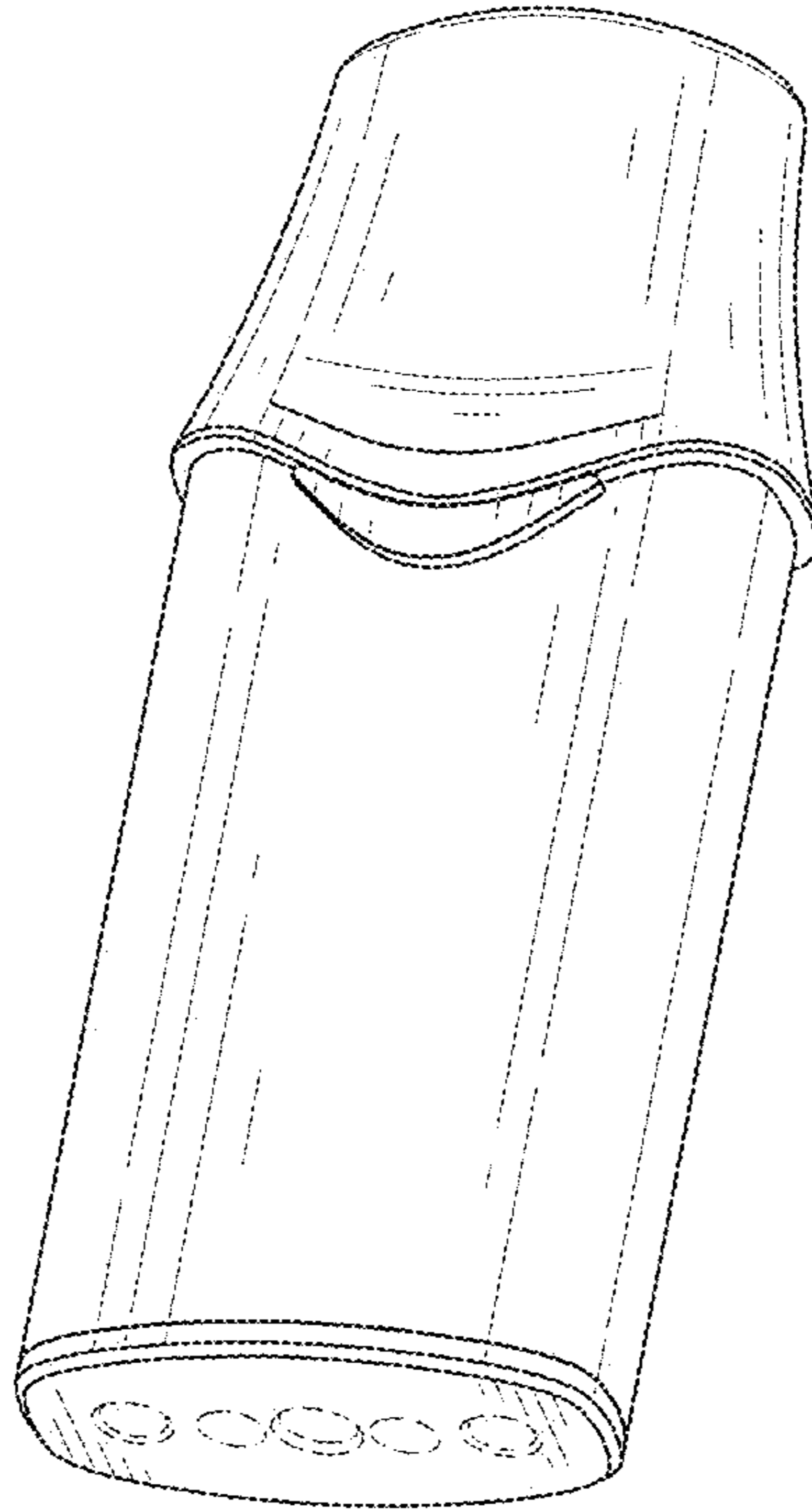

FIG. 7

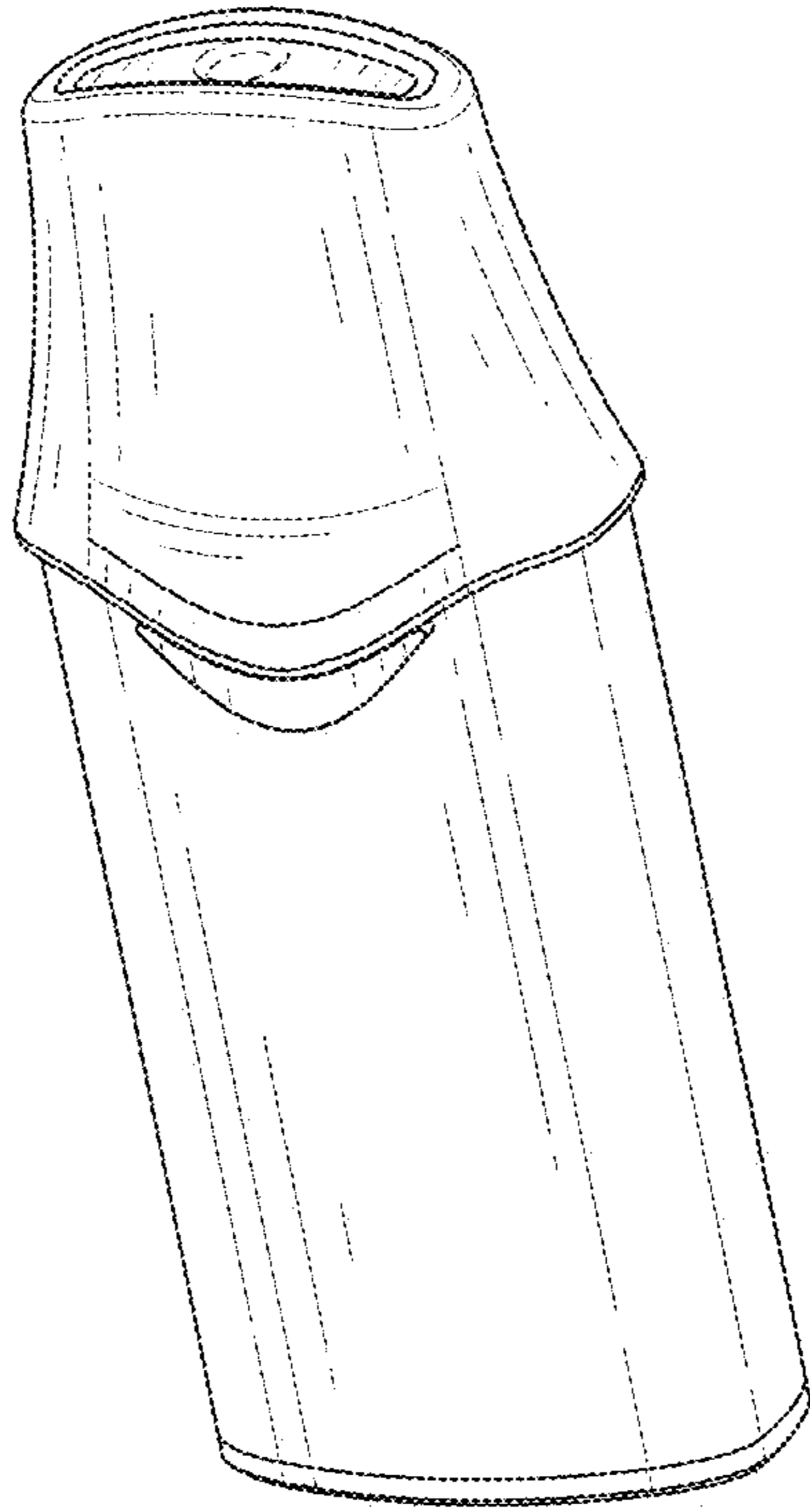

FIG. 8

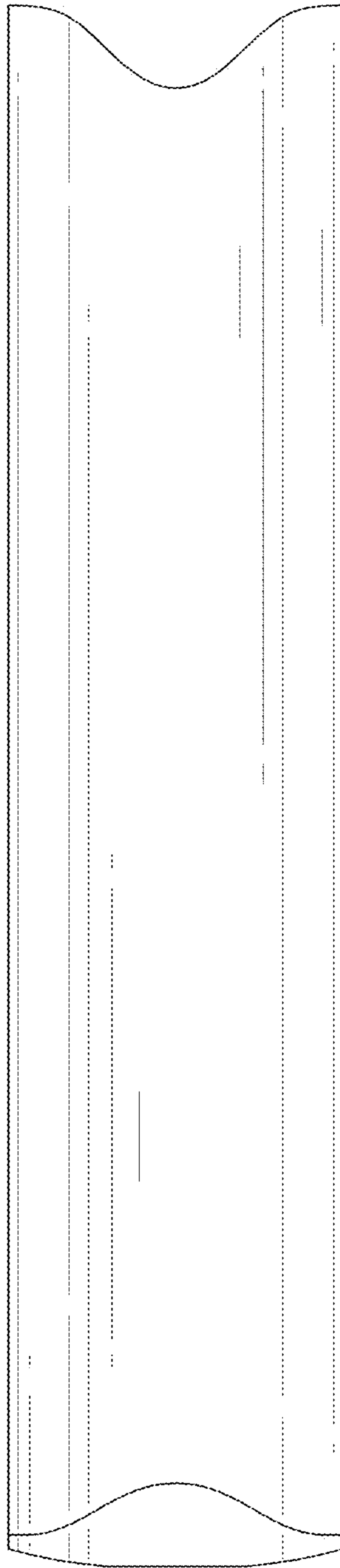

FIG. 9

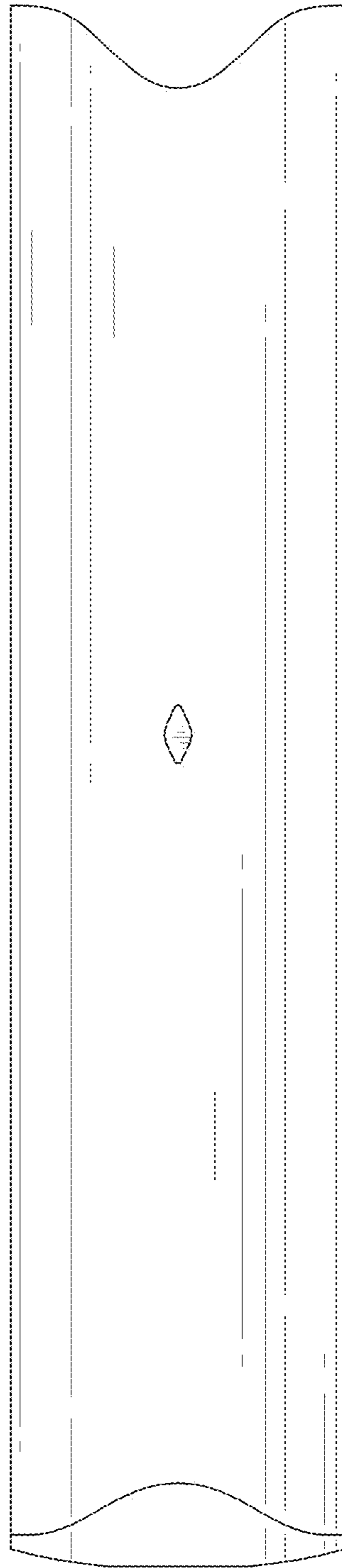

FIG. 10

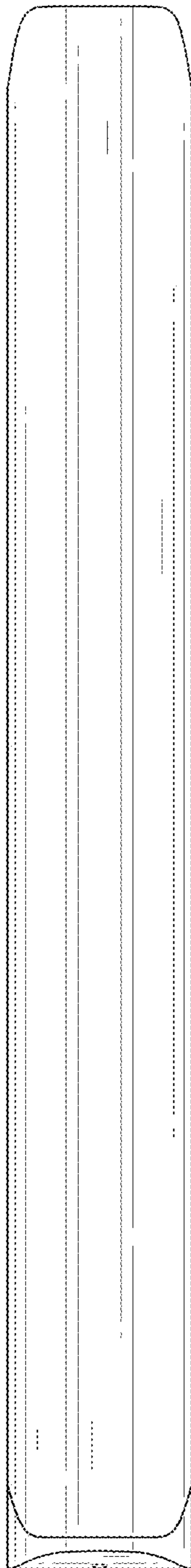

FIG. 11

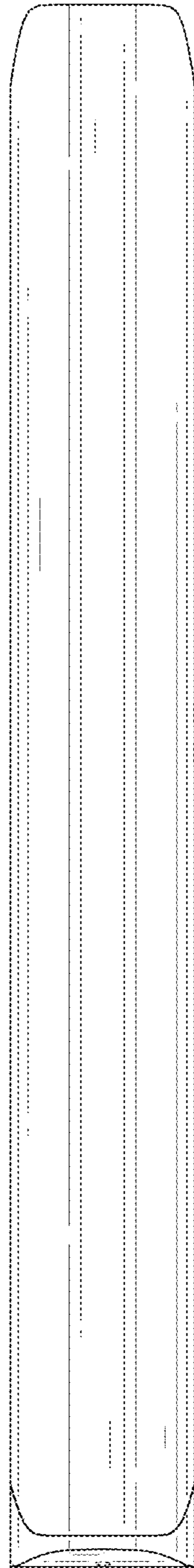

FIG. 12



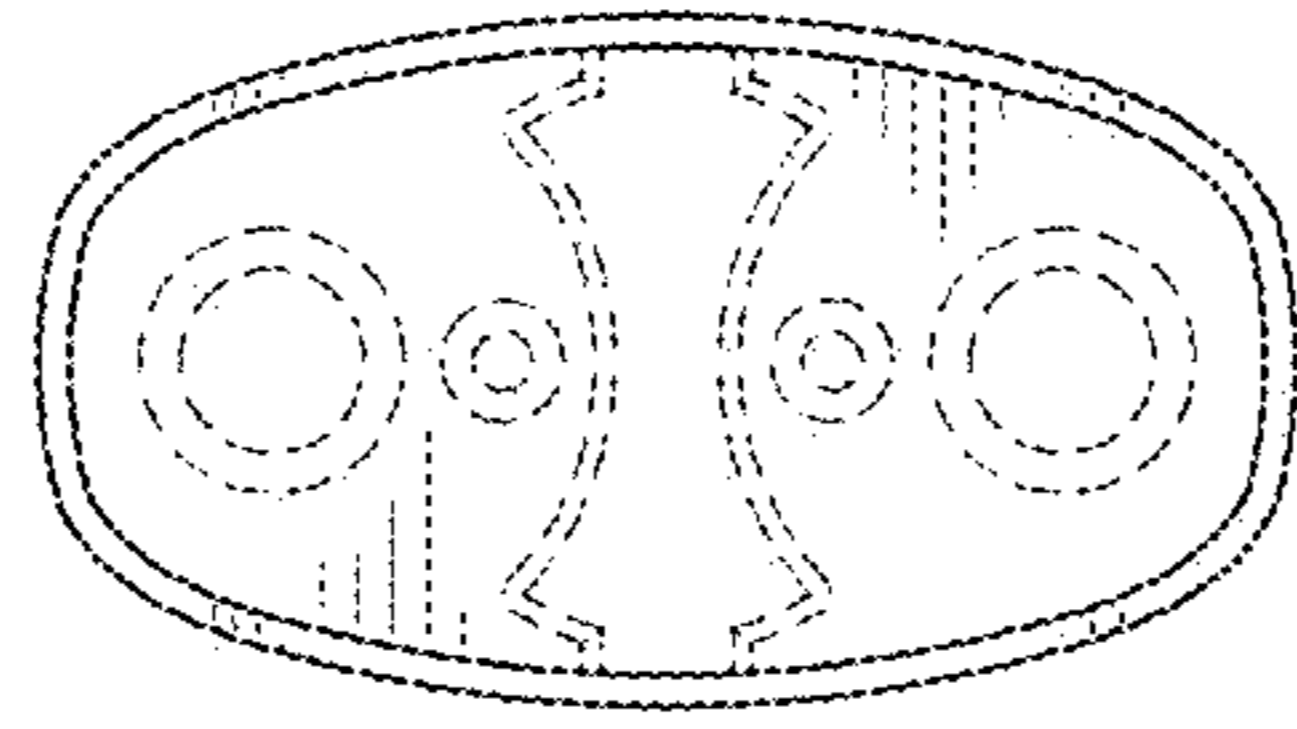

FIG. 13

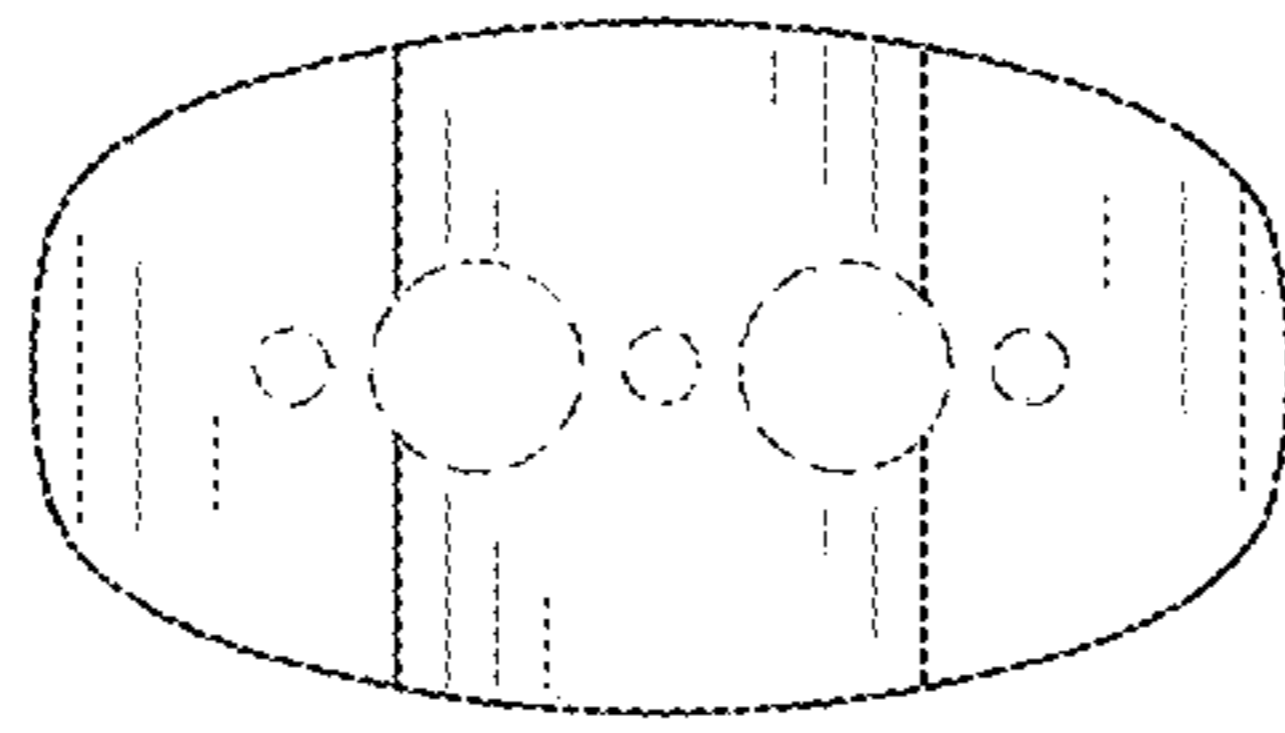

FIG. 14

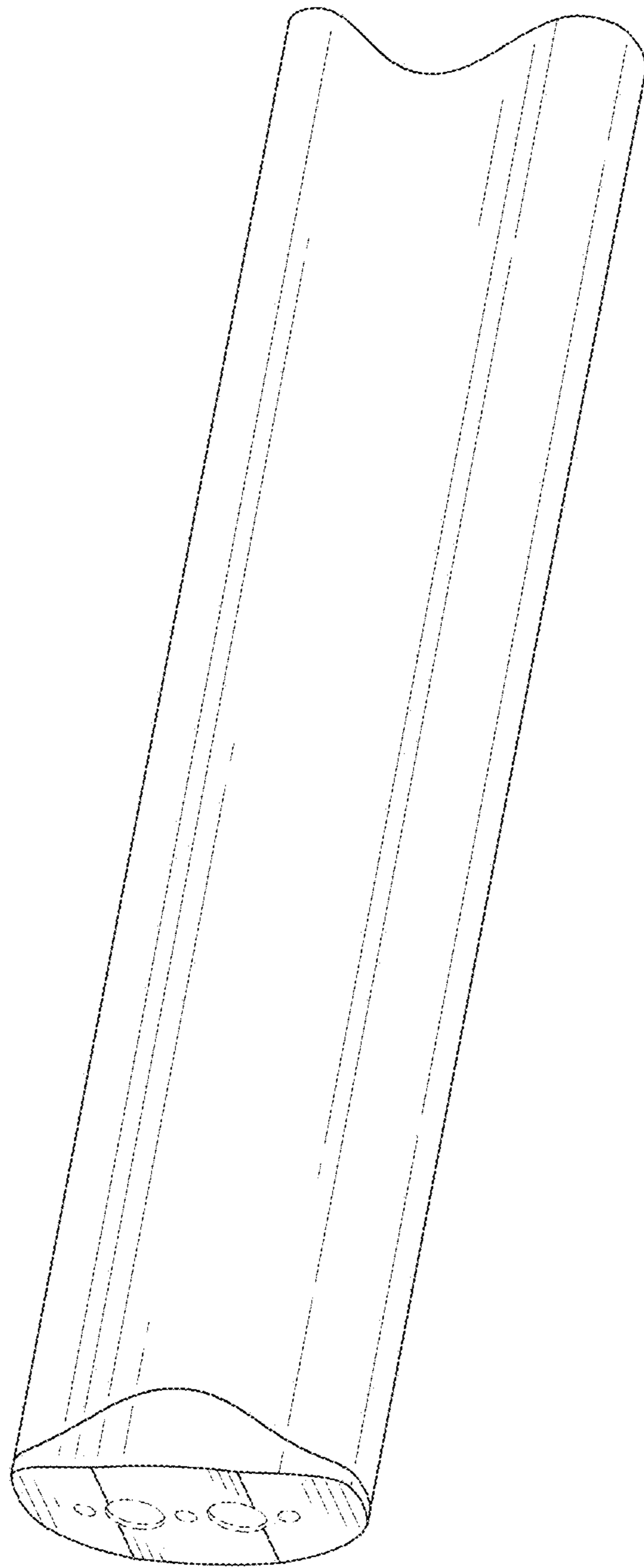

FIG. 15

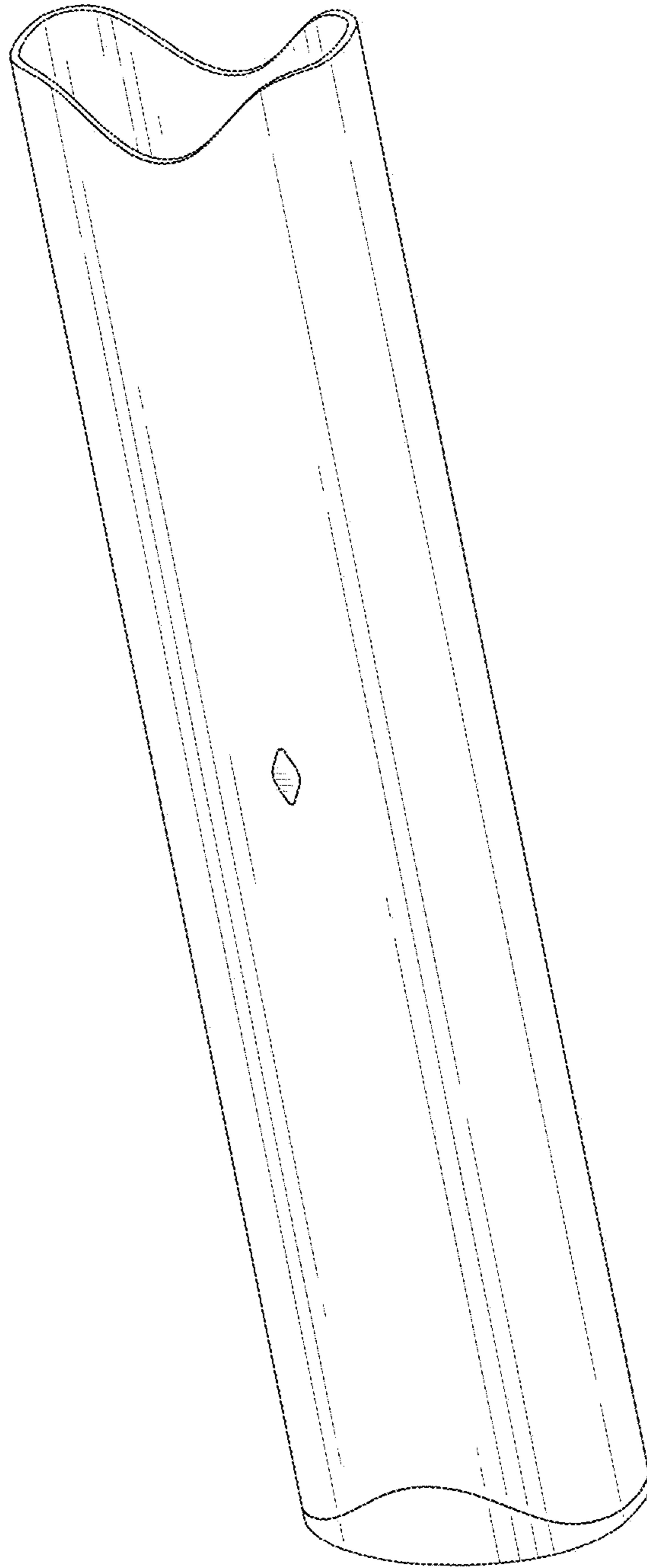

FIG. 16

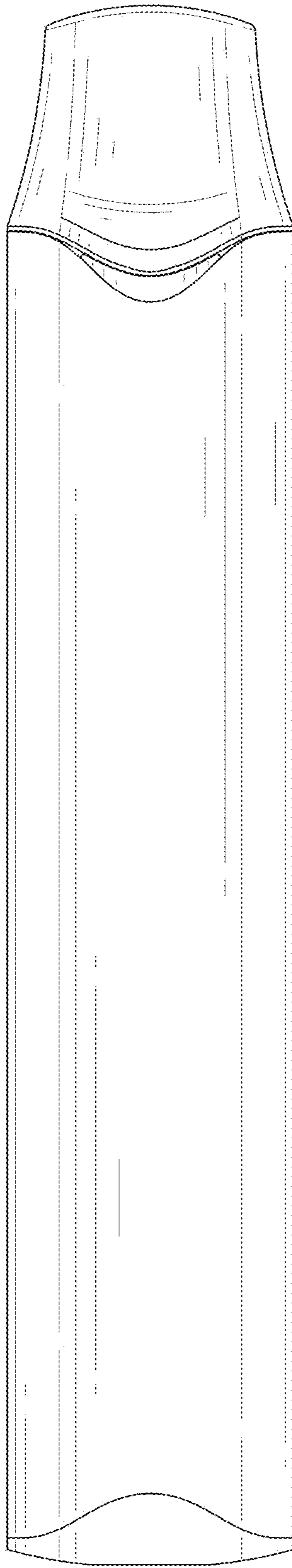

FIG. 17

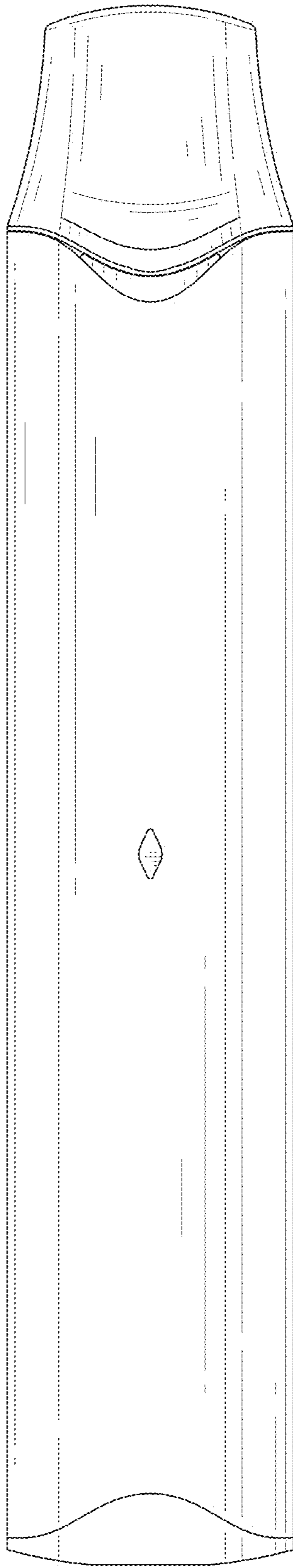

FIG. 18



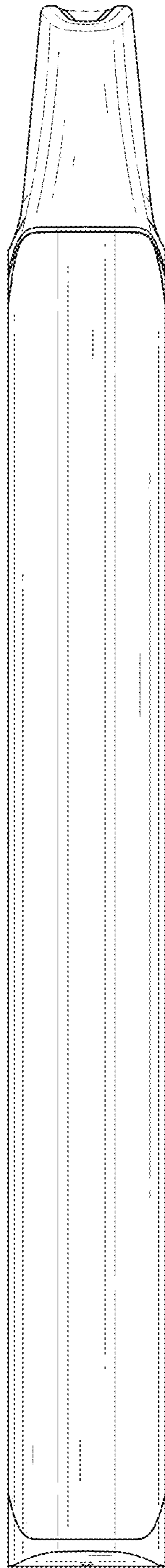

FIG. 19

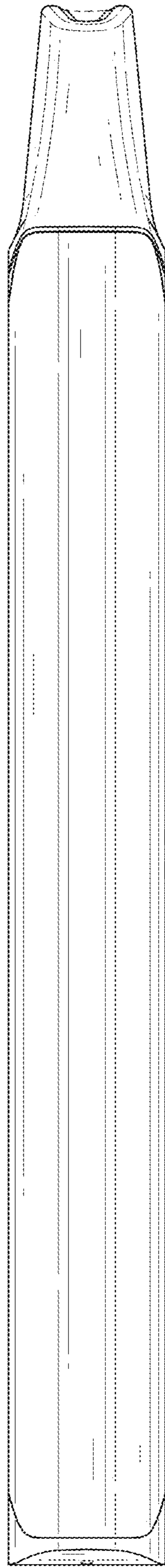

FIG. 20

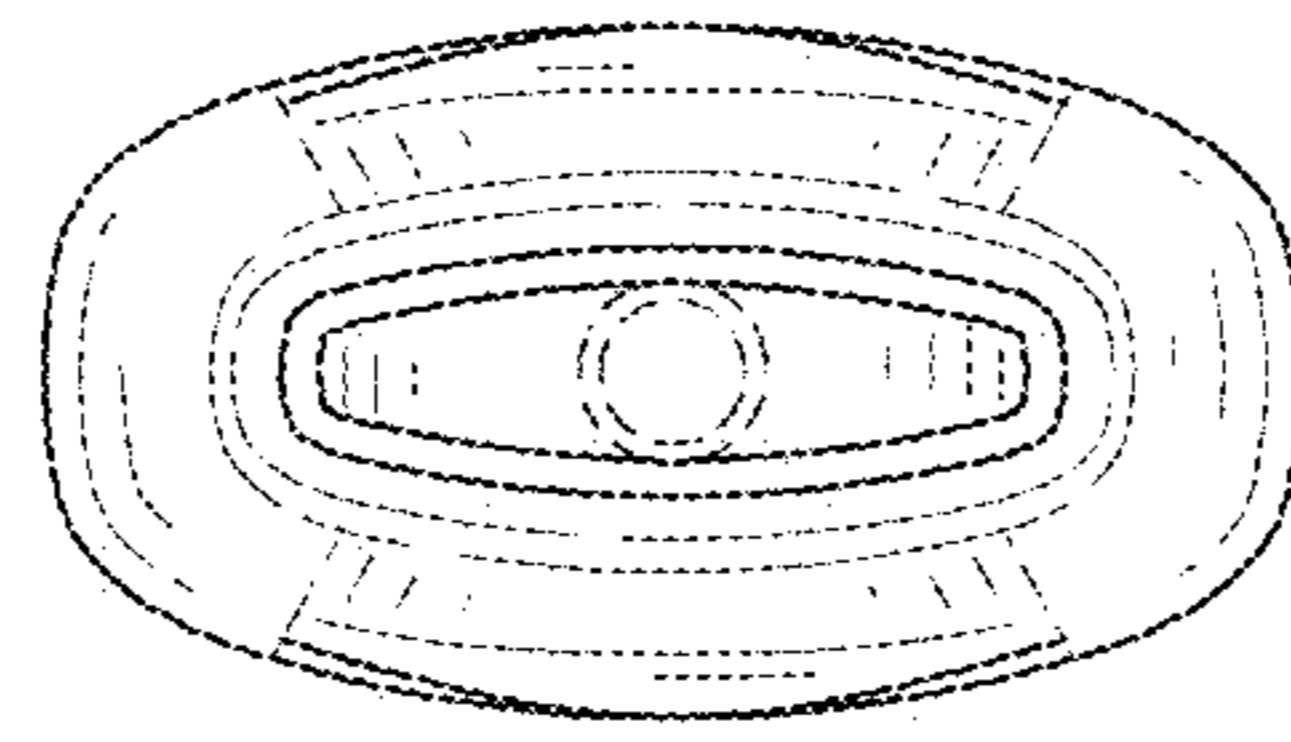

FIG. 21

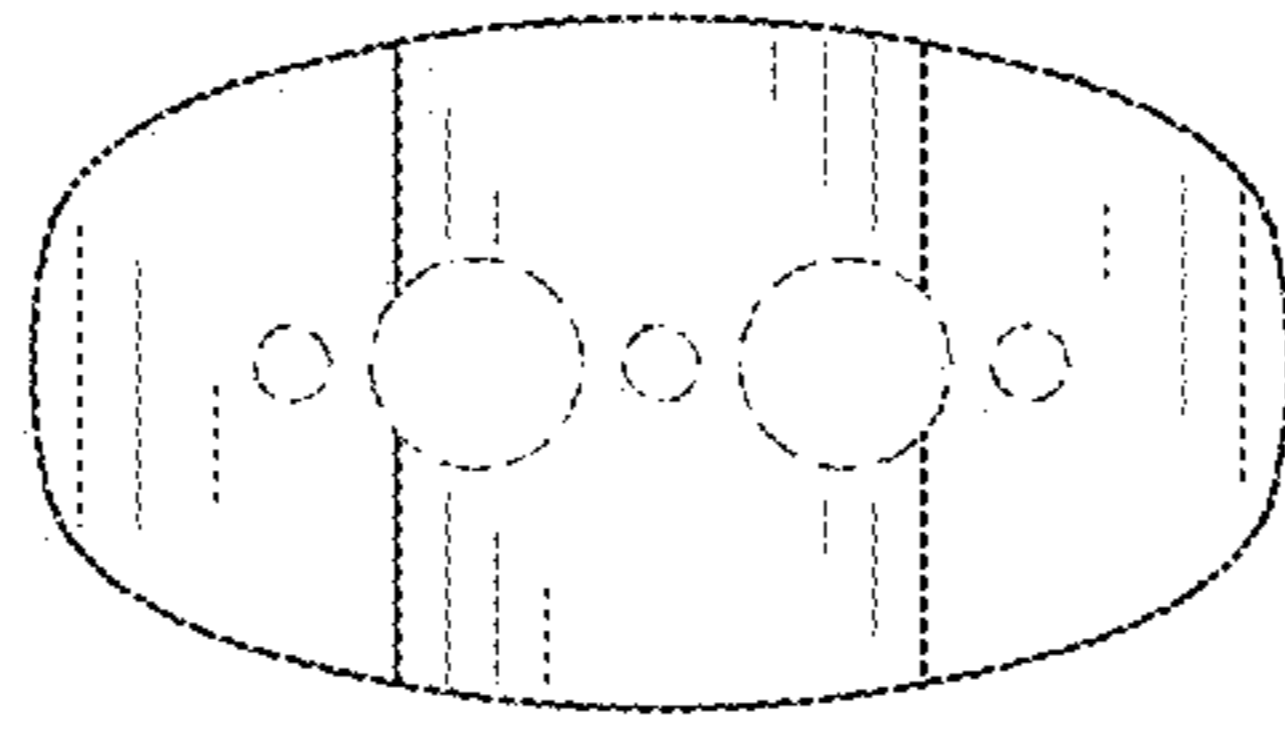

FIG. 22

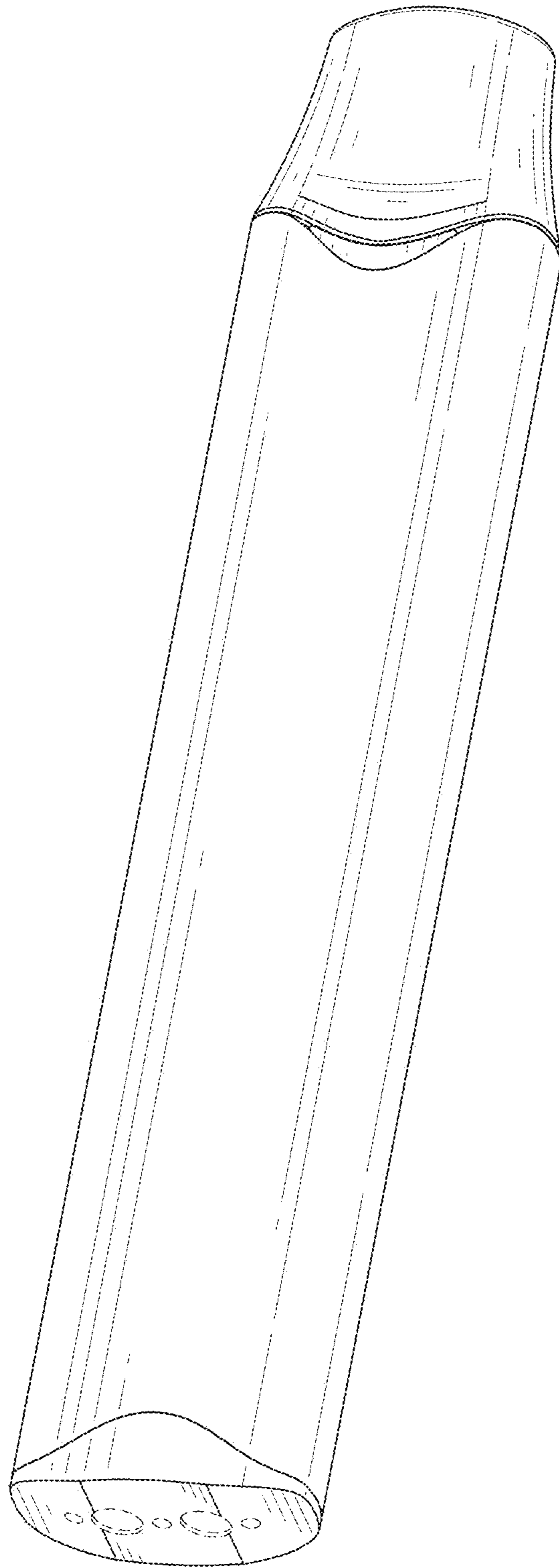

FIG. 23

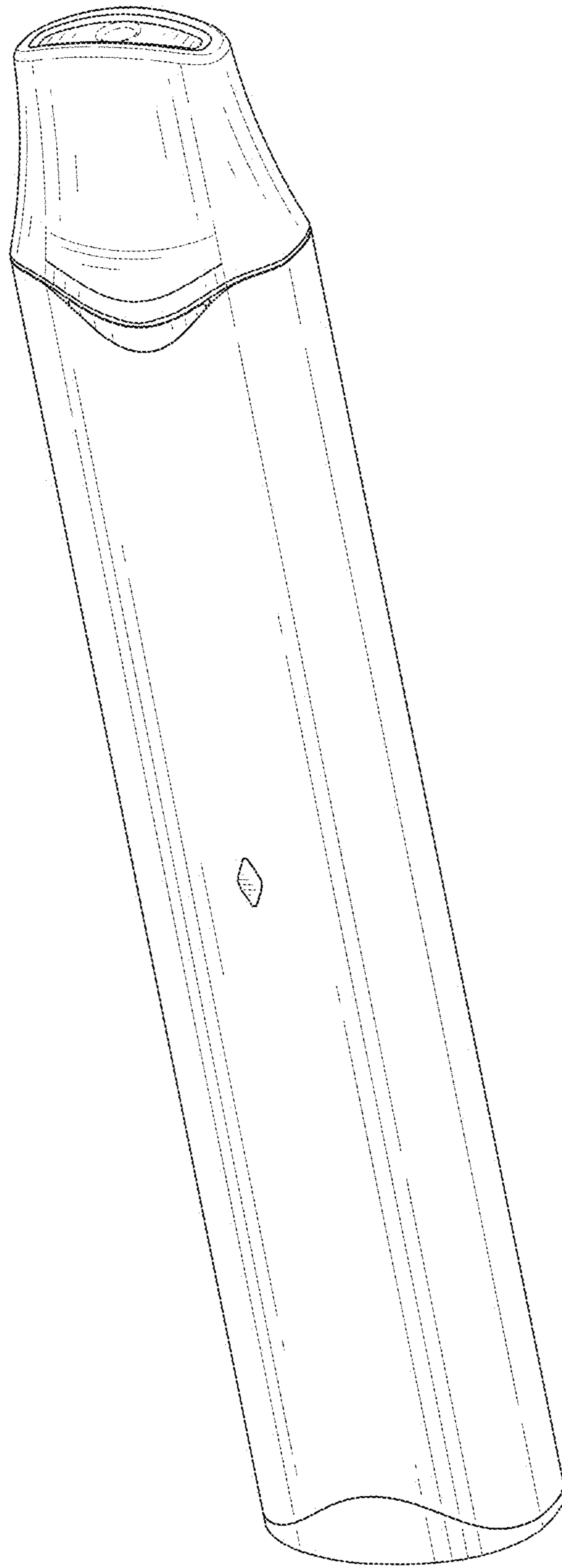

FIG. 24