



US00D875272S

(12) **United States Design Patent**
Muller et al.

(10) **Patent No.:** **US D875,272 S**
(45) **Date of Patent:** **** Feb. 11, 2020**

- (54) **TUBE RETENTION TRAY**
- (71) Applicant: **Becton, Dickinson and Company**,
Franklin Lakes, NJ (US)
- (72) Inventors: **Charles D. Muller**, Glen Rock, PA
(US); **Steven C. Rotundo**, Baltimore,
MD (US)
- (73) Assignee: **Becton, Dickinson and Company**,
Franklin Lakes, NJ (US)

7,187,286 B2 * 3/2007 Morris B01L 3/5027
340/572.1
D574,506 S * 8/2008 Monks D24/224
D598,566 S † 8/2009 Allaer D24/230
D608,013 S † 1/2010 Coulling D24/224
D639,447 S * 6/2011 Karpiloff D24/230
D654,186 S † 2/2012 Park D24/227
D673,294 S * 12/2012 Motadel D24/227
D675,748 S † 2/2013 Hilligoss D24/230
8,597,597 B2 † 12/2013 Deutsch B01L 3/5085
422/553
D699,371 S † 2/2014 Williams D24/230
(Continued)

(**) Term: **15 Years**

(21) Appl. No.: **29/688,428**

(22) Filed: **Apr. 22, 2019**

Related U.S. Application Data

(62) Division of application No. 29/564,495, filed on May 13, 2016, now Pat. No. Des. 849,961.

(51) **LOC (12) Cl.** **24-02**

(52) **U.S. Cl.**
USPC **D24/224**

(58) **Field of Classification Search**
USPC D24/223–230, 232, 216–217; 422/569,
422/551–553, 560–562, 400; 211/126.1,
211/74, 70.1; 435/126.1, 74, 70.1;
206/433
CPC B01L 9/06; B01L 9/065
See application file for complete search history.

(56) **References Cited**

U.S. PATENT DOCUMENTS

D414,271 S † 9/1999 Mendoza D24/224
D420,743 S † 2/2000 Monks D24/224
D421,498 S * 3/2000 Livingston D24/224
D441,091 S † 4/2001 Day D24/224
D452,740 S † 1/2002 Brennan D24/216
7,070,740 B1 * 7/2006 Matson B01J 19/0046
366/139

OTHER PUBLICATIONS

Design U.S. Appl. No. 29/688,431, filed Apr. 22, 2019 (Muller, et al.).

Primary Examiner — Susan Bennett Hattan

Assistant Examiner — Rebecca Tsehaye

(74) *Attorney, Agent, or Firm* — Lerner, David,
Littenberg, Krumholz & Mentlik, LLP

(57) **CLAIM**

The ornamental design for a tube retention tray, as shown and described.

DESCRIPTION

FIG. 1 is a front perspective view of a tube retention tray according to our design;
FIG. 2 is a front elevational view thereof;
FIG. 3 is a rear elevational view thereof;
FIG. 4 is a right side elevational view thereof;
FIG. 5 is a left side elevational view thereof;
FIG. 6 is a top plan view thereof;
FIG. 7 is a bottom plan view thereof; and,
FIG. 8 is an exploded front perspective view thereof.
The broken lines illustrate unclaimed environmental structure and form no part of the claimed design.

1 Claim, 4 Drawing Sheets

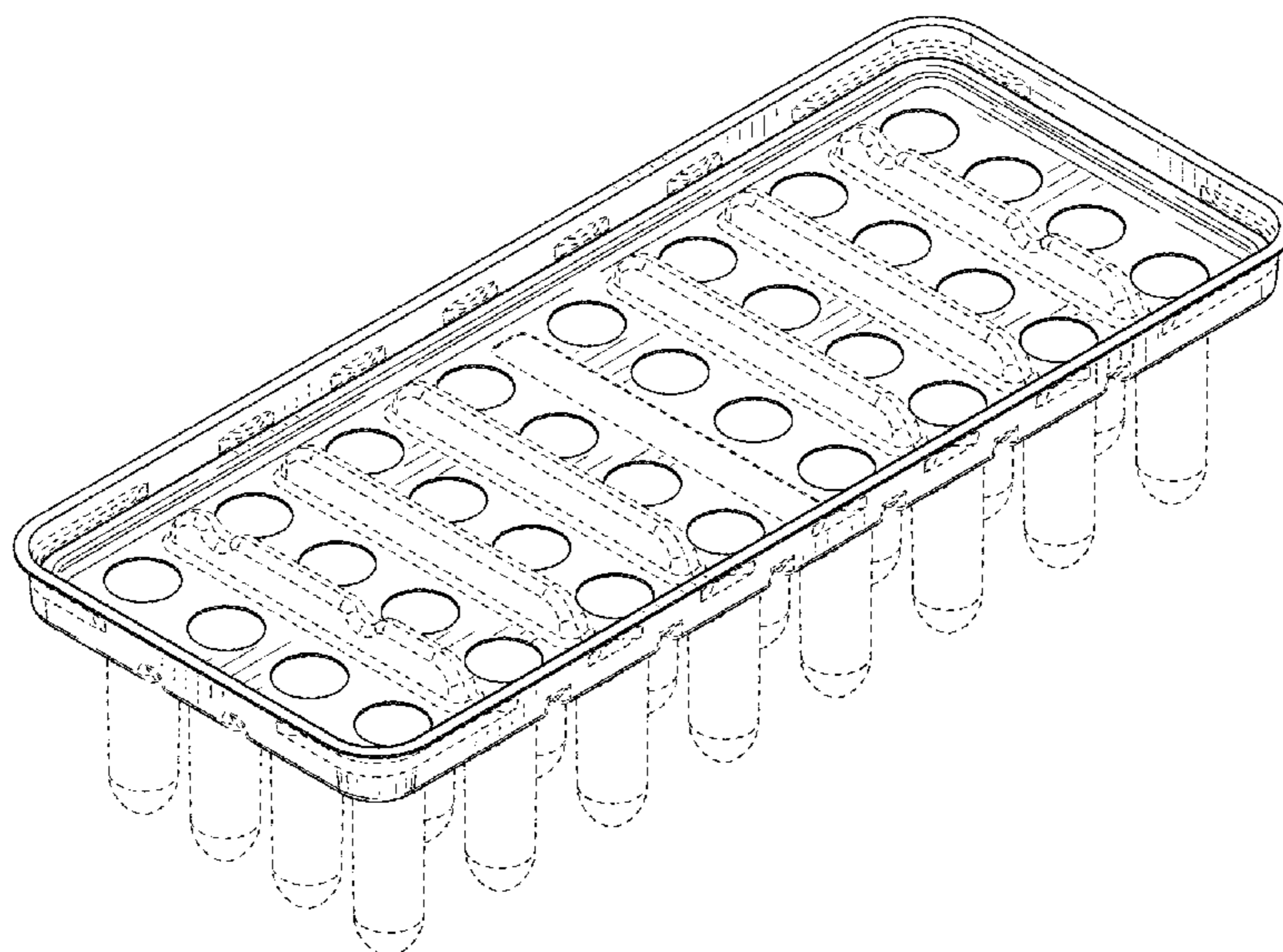

(56)

References Cited

U.S. PATENT DOCUMENTS

8,647,593 B2 ‡ 2/2014 Yin B01L 9/523
 211/126.1
 D709,323 S * 7/2014 Brown D7/213
 D710,024 S ‡ 7/2014 Guo D24/230
 D718,465 S ‡ 11/2014 Tajima D24/224
 8,906,327 B2 ‡ 12/2014 Williams B01L 9/543
 422/524
 D724,236 S ‡ 3/2015 Motadel D24/227
 D734,867 S * 7/2015 Smeja D24/230
 9,079,183 B2 * 7/2015 Yin B01L 9/523
 9,798,862 B2 * 10/2017 Parviainen B01L 3/54
 D808,540 S * 1/2018 Johns D24/227
 D810,959 S ‡ 2/2018 Langhoff D24/230
 D815,753 S ‡ 4/2018 Curry D24/227
 D825,774 S * 8/2018 Self D24/224
 D825,775 S * 8/2018 Muller D24/230
 D826,426 S * 8/2018 Muller D24/230
 D827,149 S * 8/2018 Self D24/224
 10,071,381 B2 * 9/2018 Welch A61B 5/15
 D831,844 S * 10/2018 Langhoff D24/224
 D836,794 S * 12/2018 Livingston D24/224
 D836,795 S * 12/2018 Livingston D24/224
 D848,638 S * 5/2019 Sims D24/226
 D849,961 S * 5/2019 Muller D24/224
 2016/0319329 A1 ‡ 11/2016 Natale G01N 35/028

* cited by examiner

‡ imported from a related application

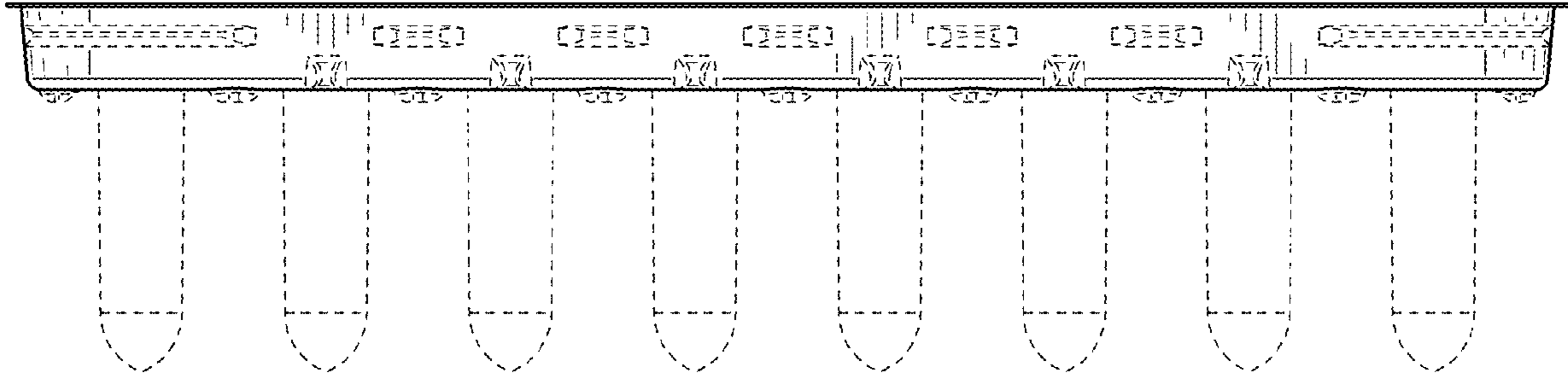

FIG. 2

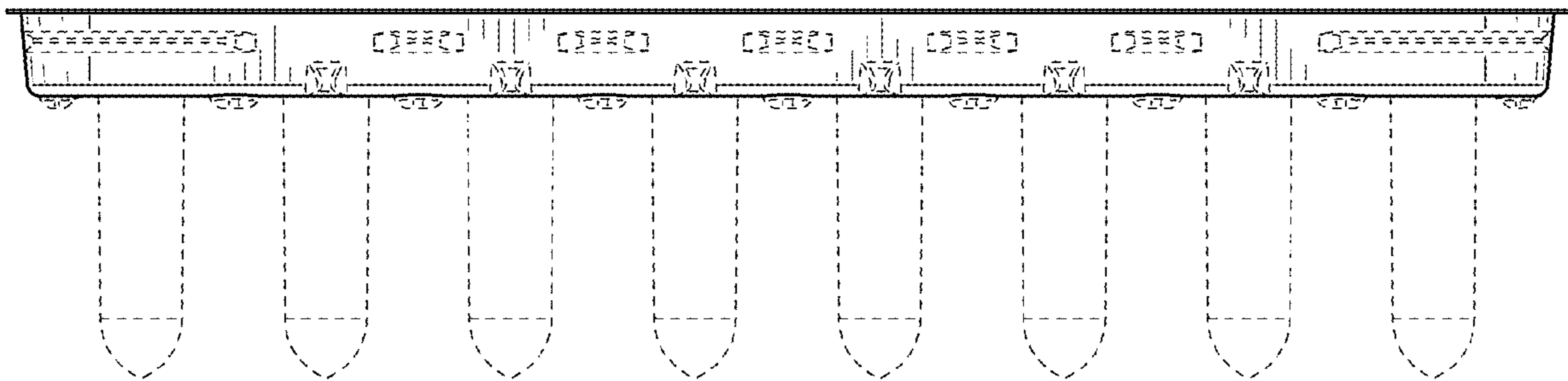

FIG. 3

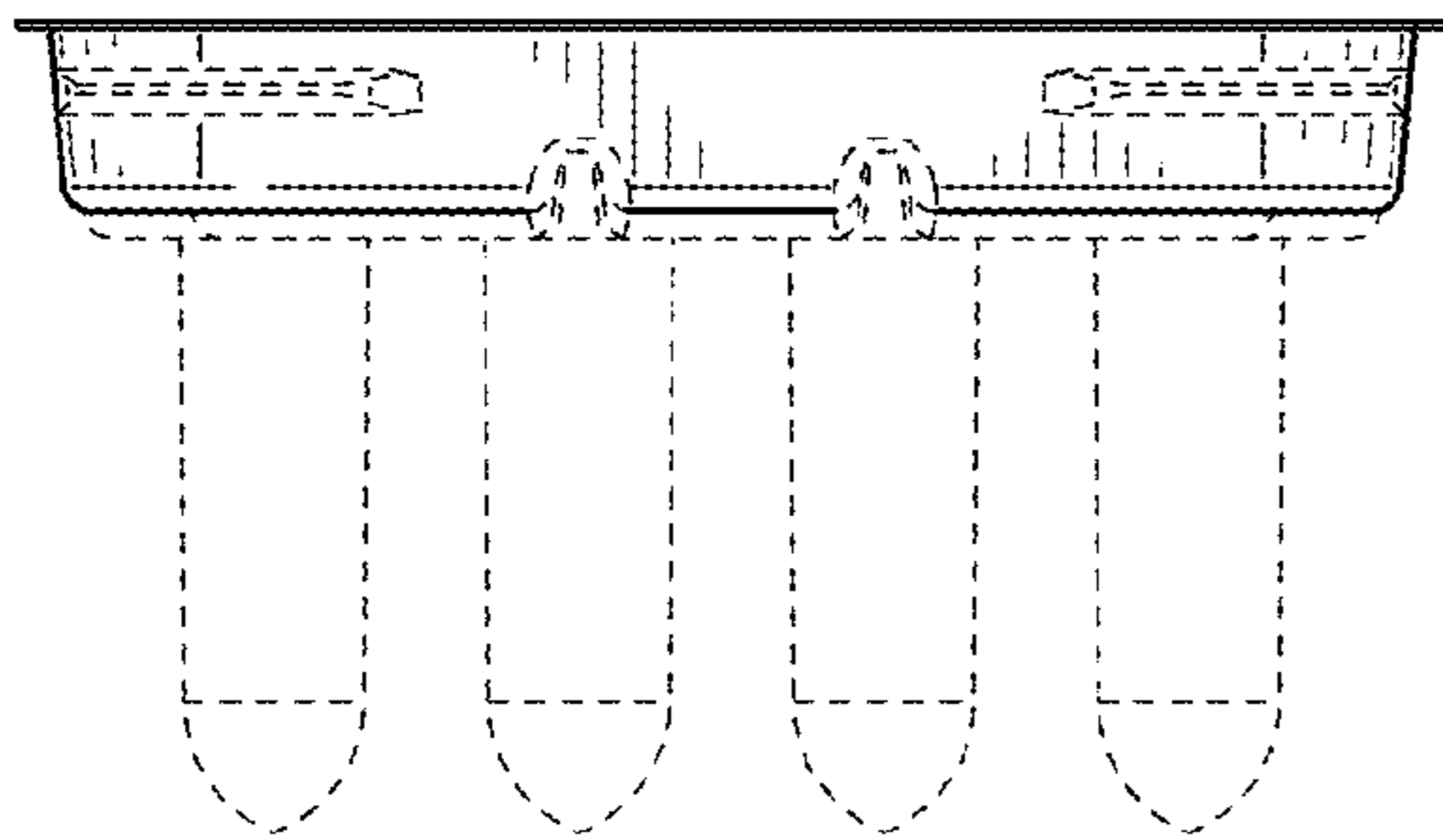

FIG. 4

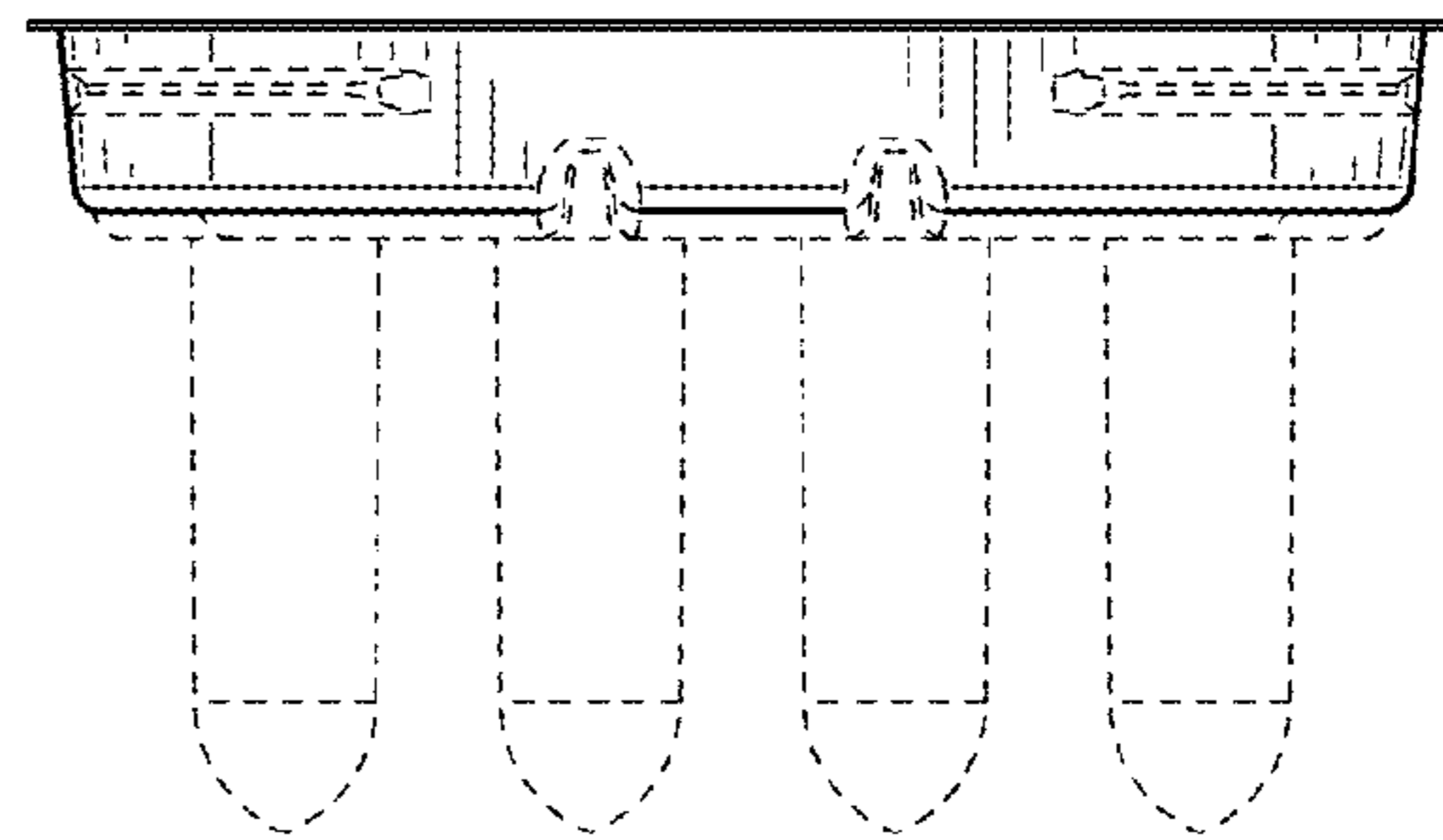

FIG. 5

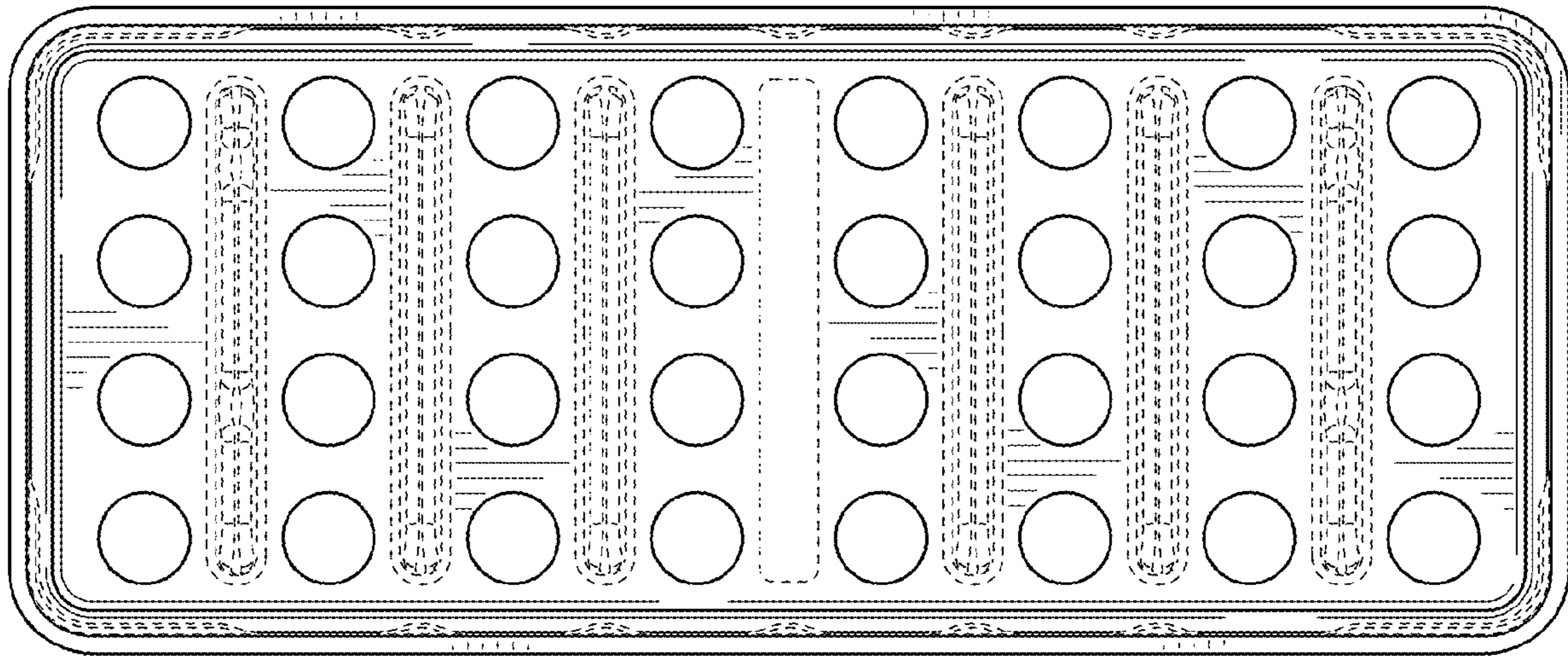

FIG. 6

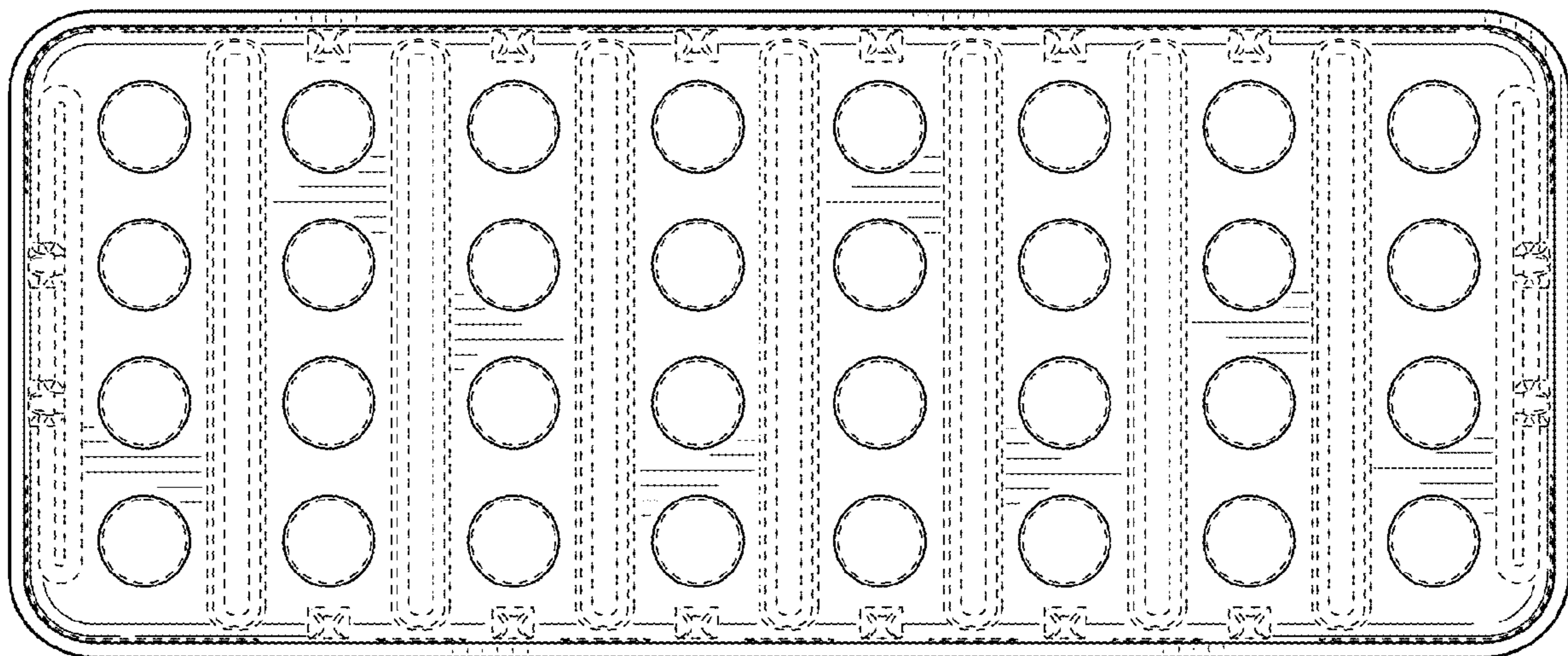

FIG. 7

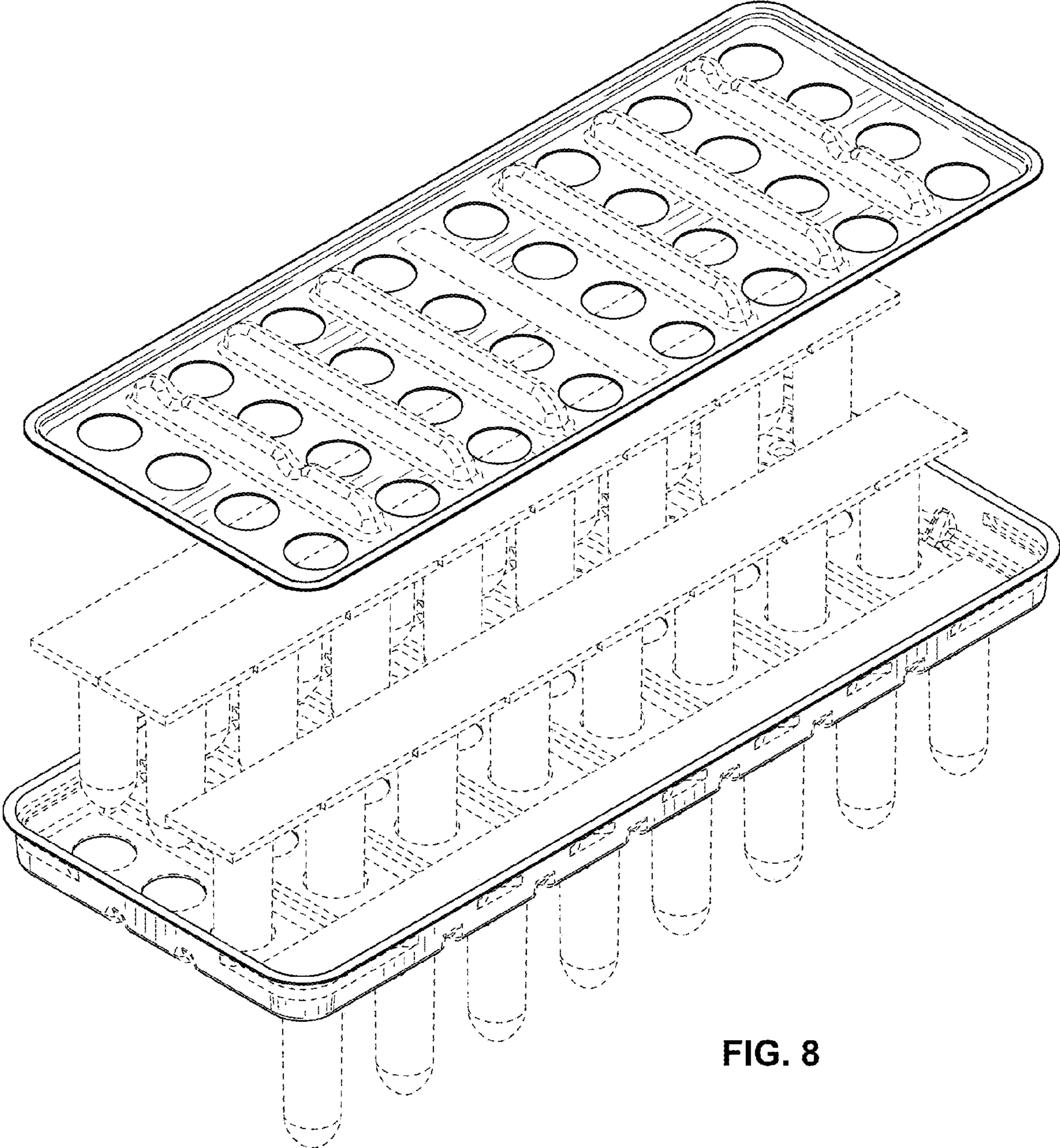

FIG. 8