



US00D875241S

(12) **United States Design Patent**
Siew et al.

(10) **Patent No.:** **US D875,241 S**

(45) **Date of Patent:** **** Feb. 11, 2020**

(54) **COMBINED REAR AND UPPER STRAP FOR A HEADGEAR**

(71) Applicant: **Fisher & Paykel Healthcare Limited**,
Auckland (NZ)

(72) Inventors: **Silas Sao Jin Siew**, Auckland (NZ);
Thomas Mark Richardson, Auckland
(NZ); **Jonathan Mark Downey**,
Auckland (NZ); **Janine Elizabeth
Collins**, Auckland (NZ); **Chris Onin
Limpin Hipolito**, Auckland (NZ); **Steve
Thomas**, Auckland (NZ); **Priyanka
Ferdinand Pereira**, Auckland (NZ);
Matthew Aaron Bradley, Auckland
(NZ)

(73) Assignee: **Fisher & Paykel Healthcare Limited**,
Auckland (NZ)

(**) Term: **15 Years**

(21) Appl. No.: **29/688,035**

(22) Filed: **Apr. 17, 2019**

Related U.S. Application Data

(62) Division of application No. 29/612,527, filed on Aug.
1, 2017, now Pat. No. Des. 851,749.

(51) **LOC (12) Cl.** **29-02**

(52) **U.S. Cl.**
USPC **D24/110.1**

(58) **Field of Classification Search**
USPC D24/110.1–110.5, 127; D2/627;
D28/41; D29/102–107, 122
CPC A61M 16/0622; A61M 16/0616; A61M
16/0816; A61M 16/08; A61M 16/0633;
A61M 16/06; A61M 16/0666; A61M
2210/0618; A61M 16/0683

See application file for complete search history.

(56) **References Cited**

U.S. PATENT DOCUMENTS

D326,540 S * 5/1992 Scholey D24/110.1
D351,226 S * 10/1994 Parvatharaj D24/110

(Continued)

Primary Examiner — Lilyana Bekic

(74) *Attorney, Agent, or Firm* — Knobbe, Martens, Olson
& Bear, LLP

(57) **CLAIM**

The ornamental design for a combined rear and upper strap
for a headgear, as shown and described.

DESCRIPTION

FIG. 1 is a front, top and right side perspective view of a
combined rear and upper strap for a headgear, showing our
new design.

FIG. 2 is a rear, bottom and left side perspective view
thereof;

FIG. 3 is a front view thereof;

FIG. 4 is a rear view thereof;

FIG. 5 is a right side view thereof;

FIG. 6 is a left side view thereof;

FIG. 7 is a bottom view thereof;

FIG. 8 is a top view thereof; and,

FIG. 9 is a sectional view thereof taken in the direction of
line 9-9 of FIG. 7.

The dashed lines in the drawings show portions of the
combined rear and upper strap for a headgear that form no
part of the claimed design.

The hatched surface treatment represents a fabric or textile
material. Hatching and line shading have been used in the
drawings to indicate a contrast in appearance.

The references to “left,” “right,” “front,” “rear,” “top,” and
“bottom” in the figure descriptions are not meant to require
certain in-use orientation; the combined rear and upper strap
for a headgear may be used in any suitable orientations.

1 Claim, 6 Drawing Sheets

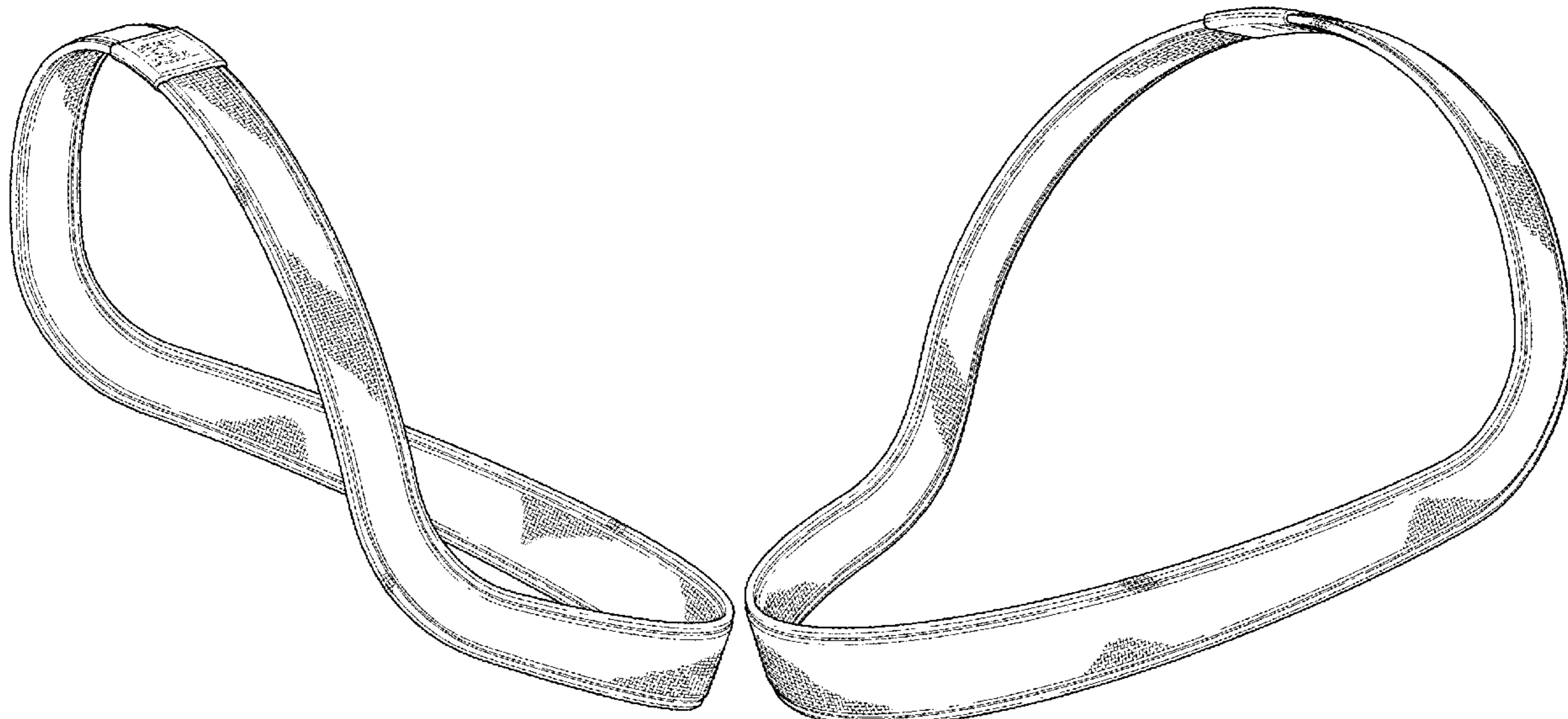

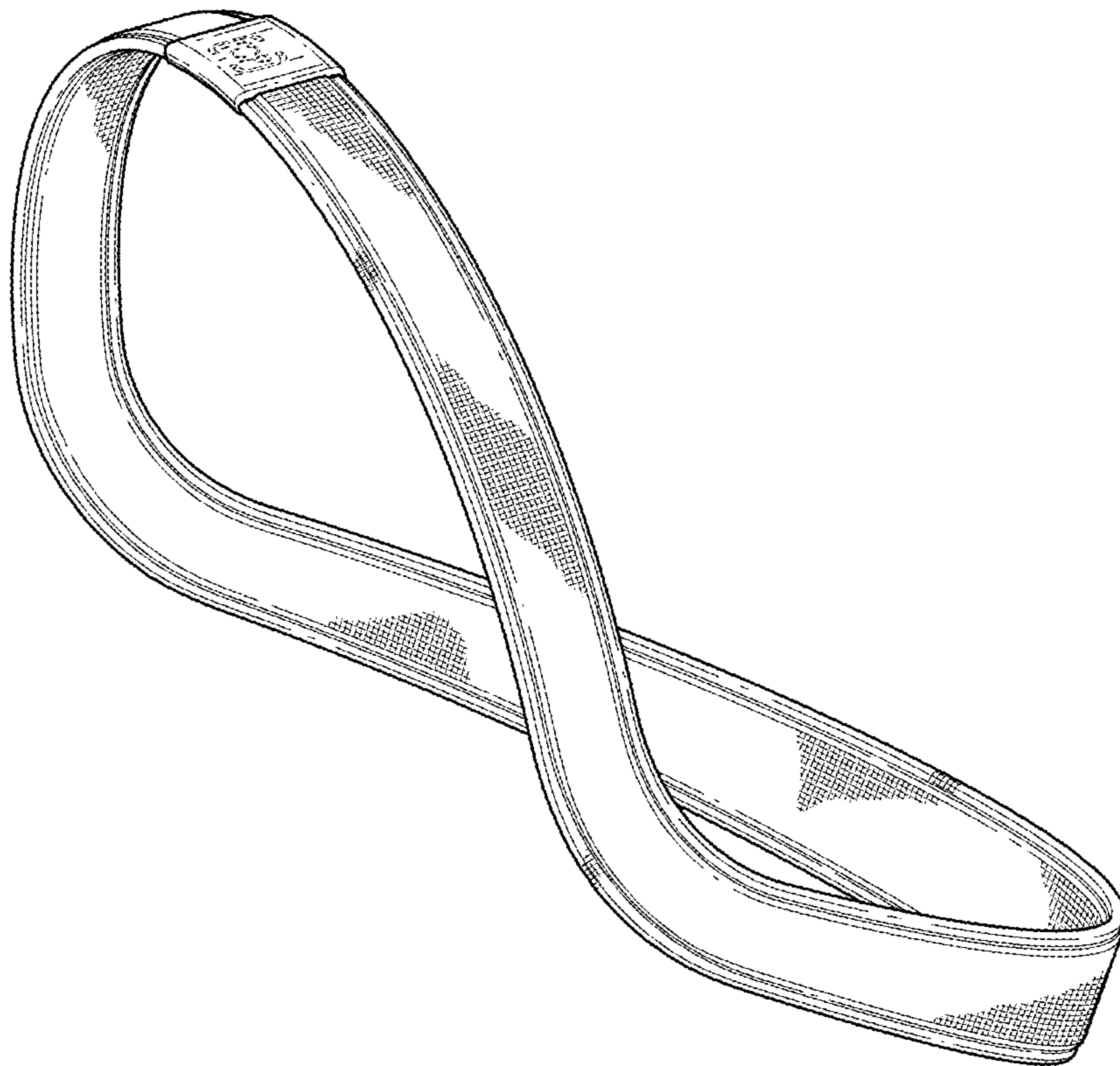

FIG. 1

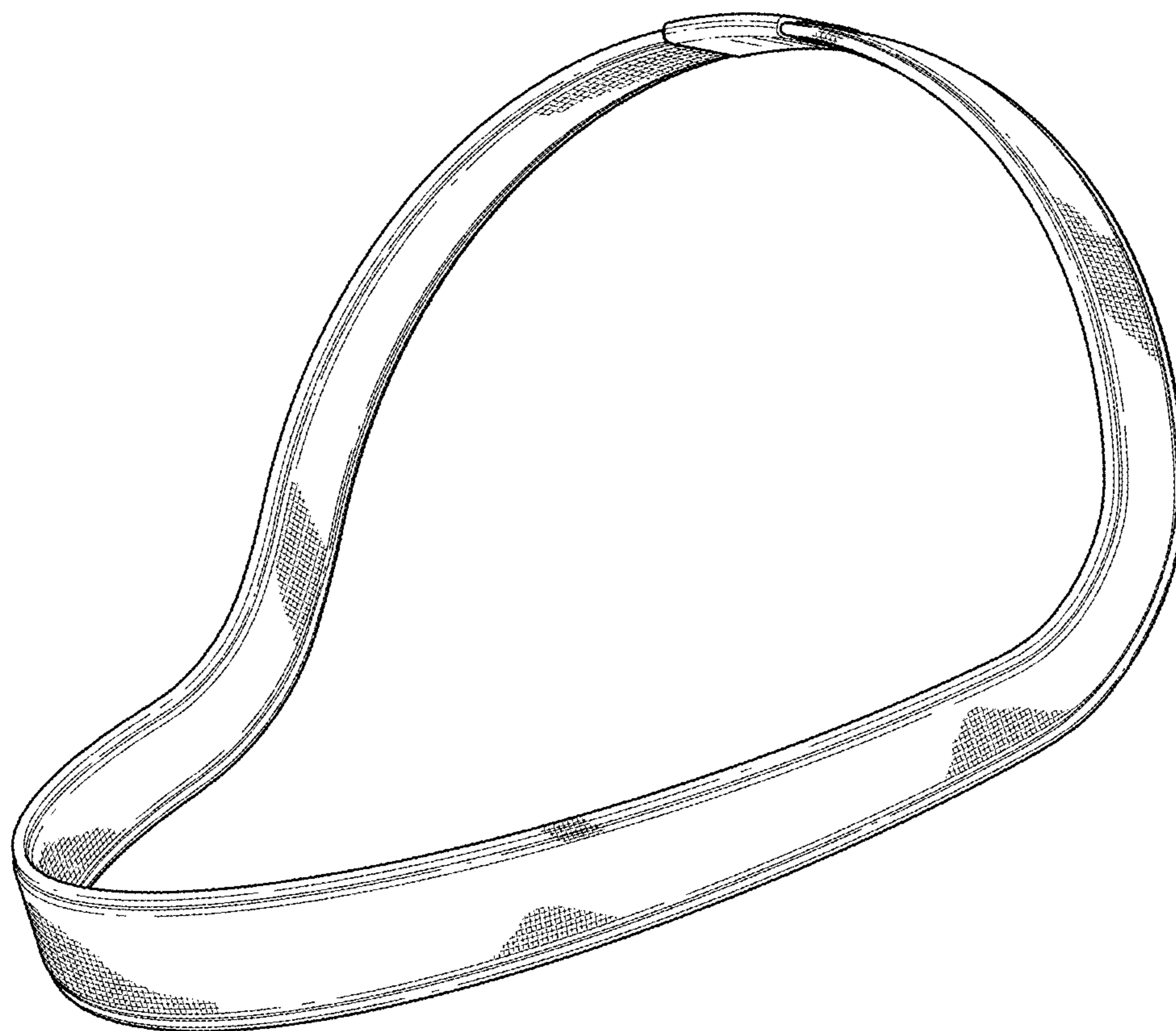

FIG. 2

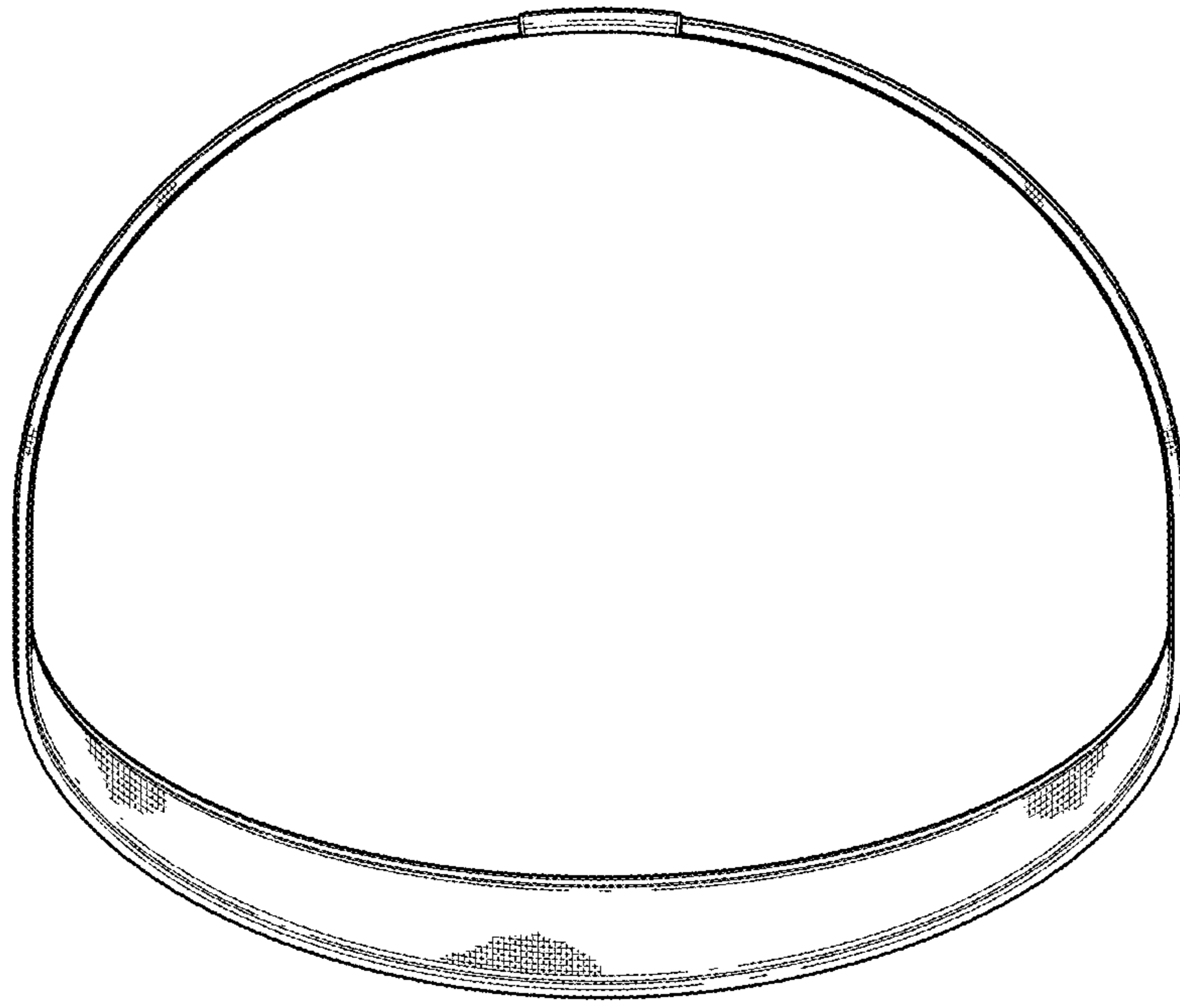

FIG. 3

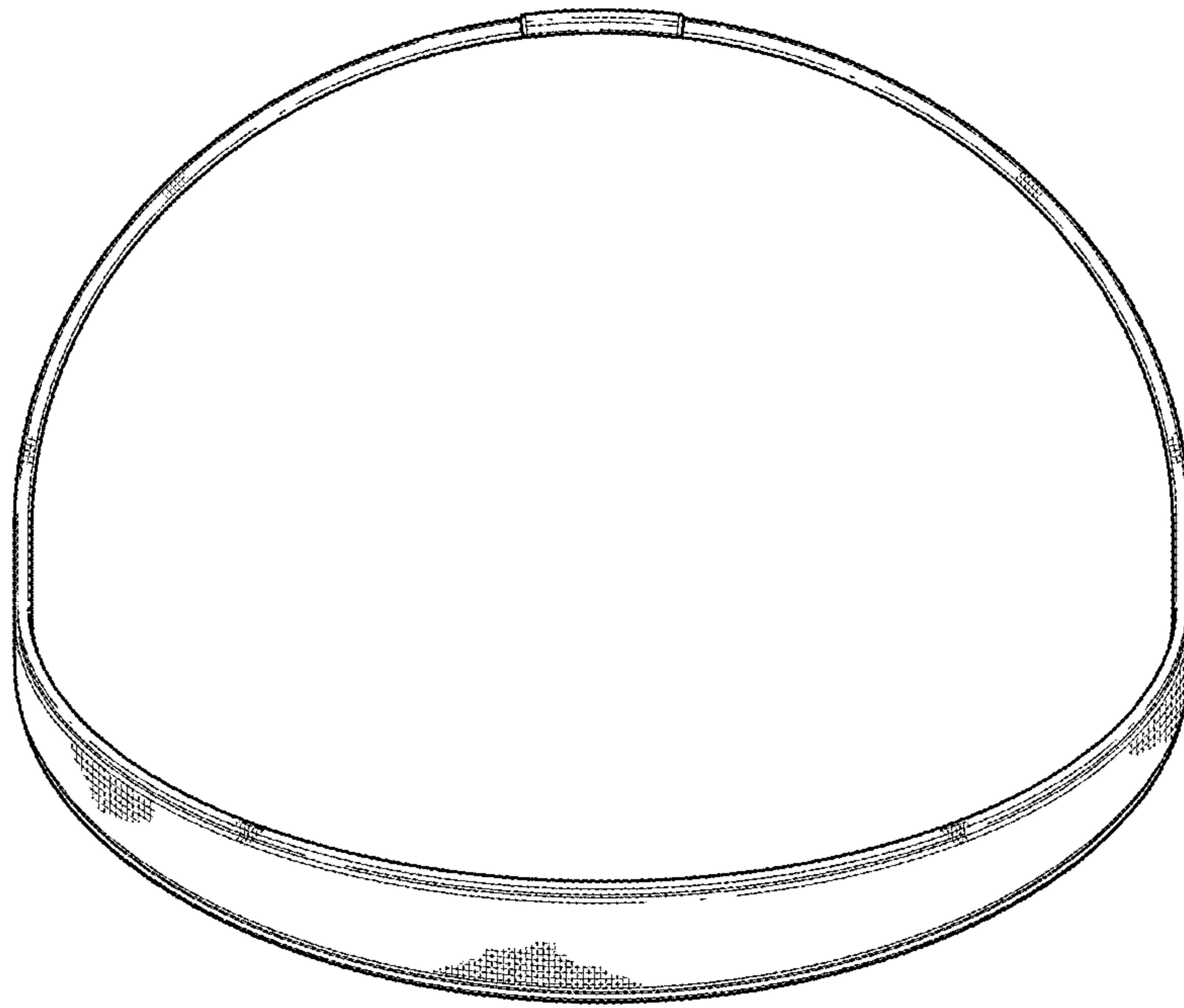

FIG. 4

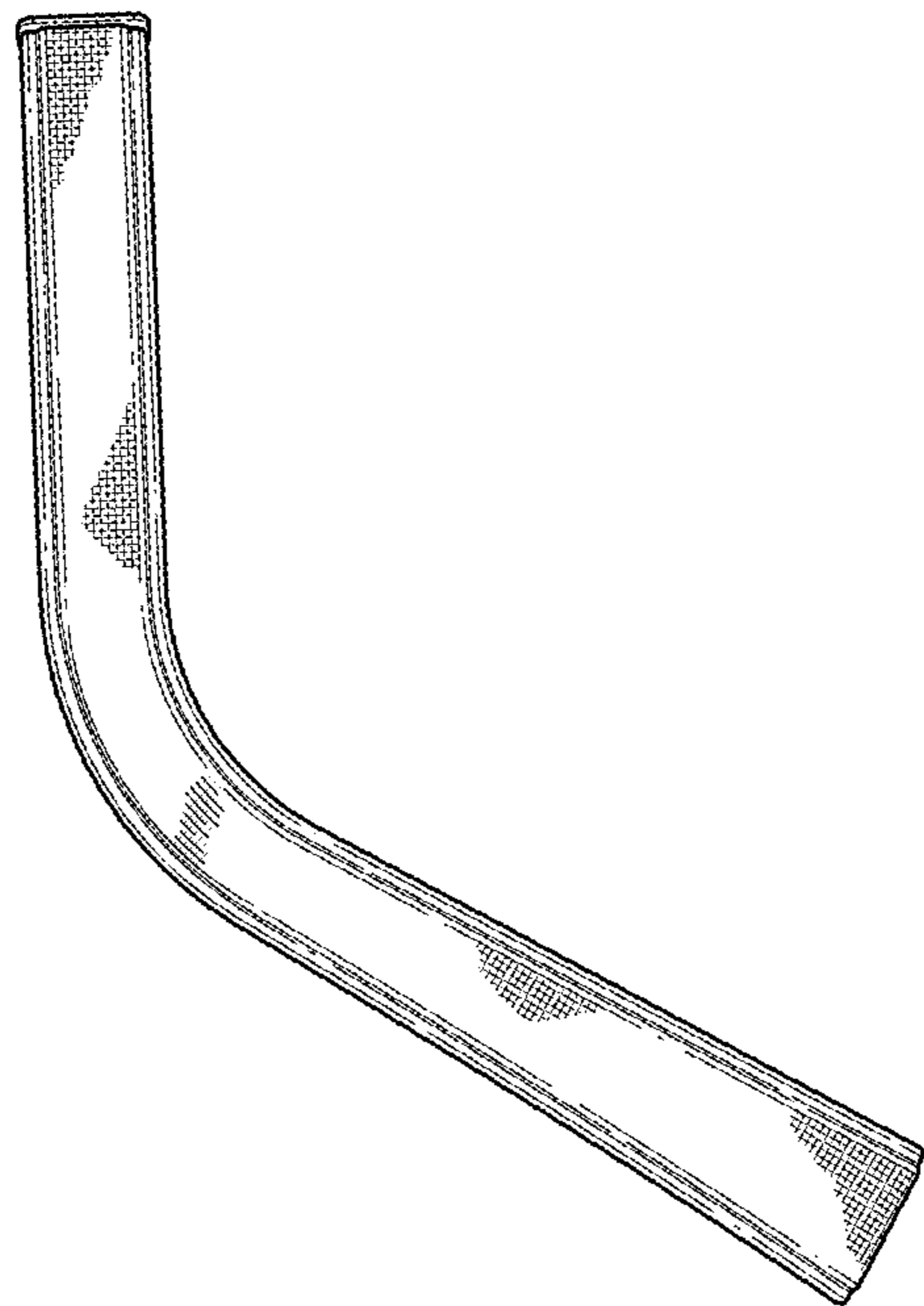

FIG. 5

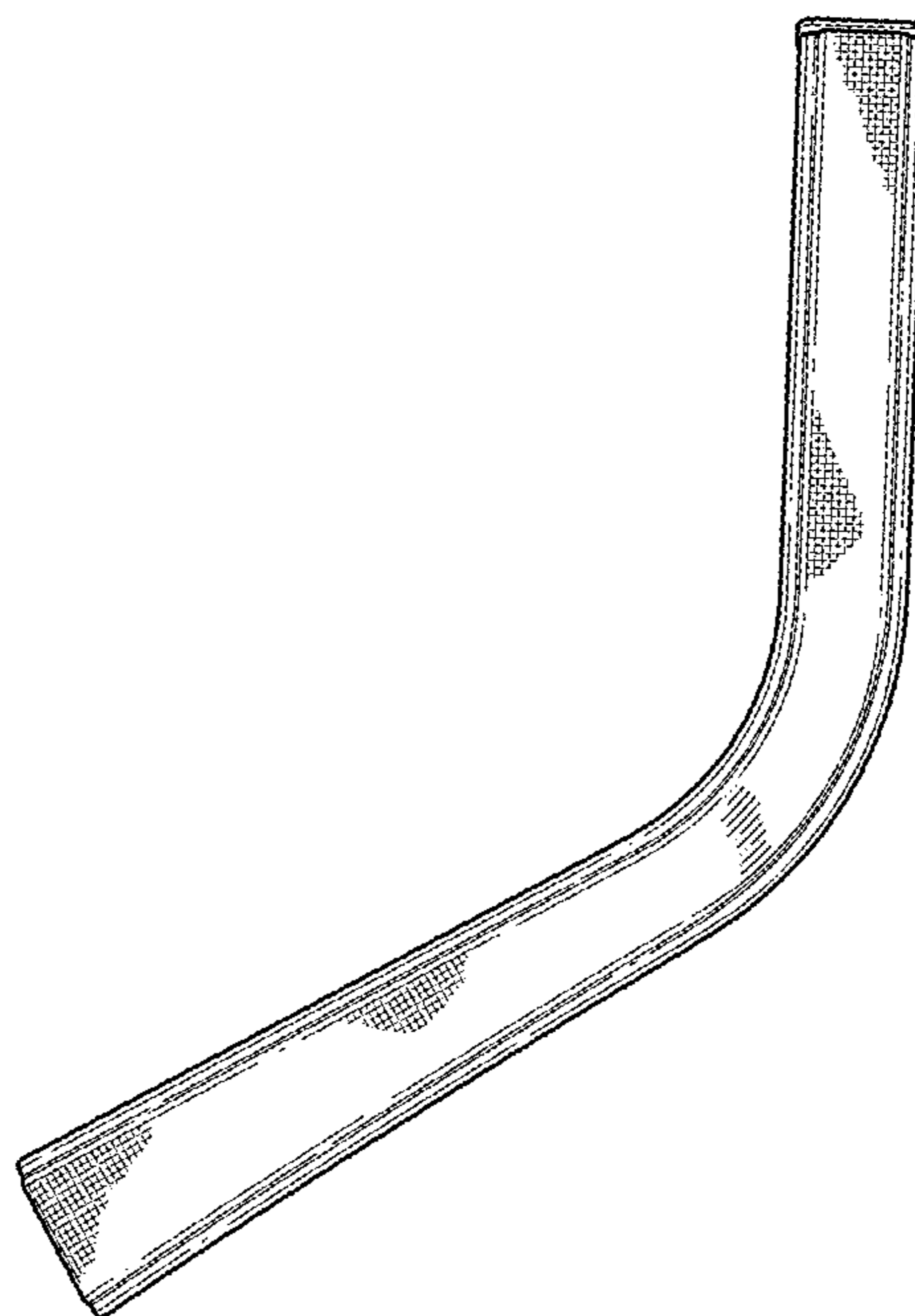

FIG. 6

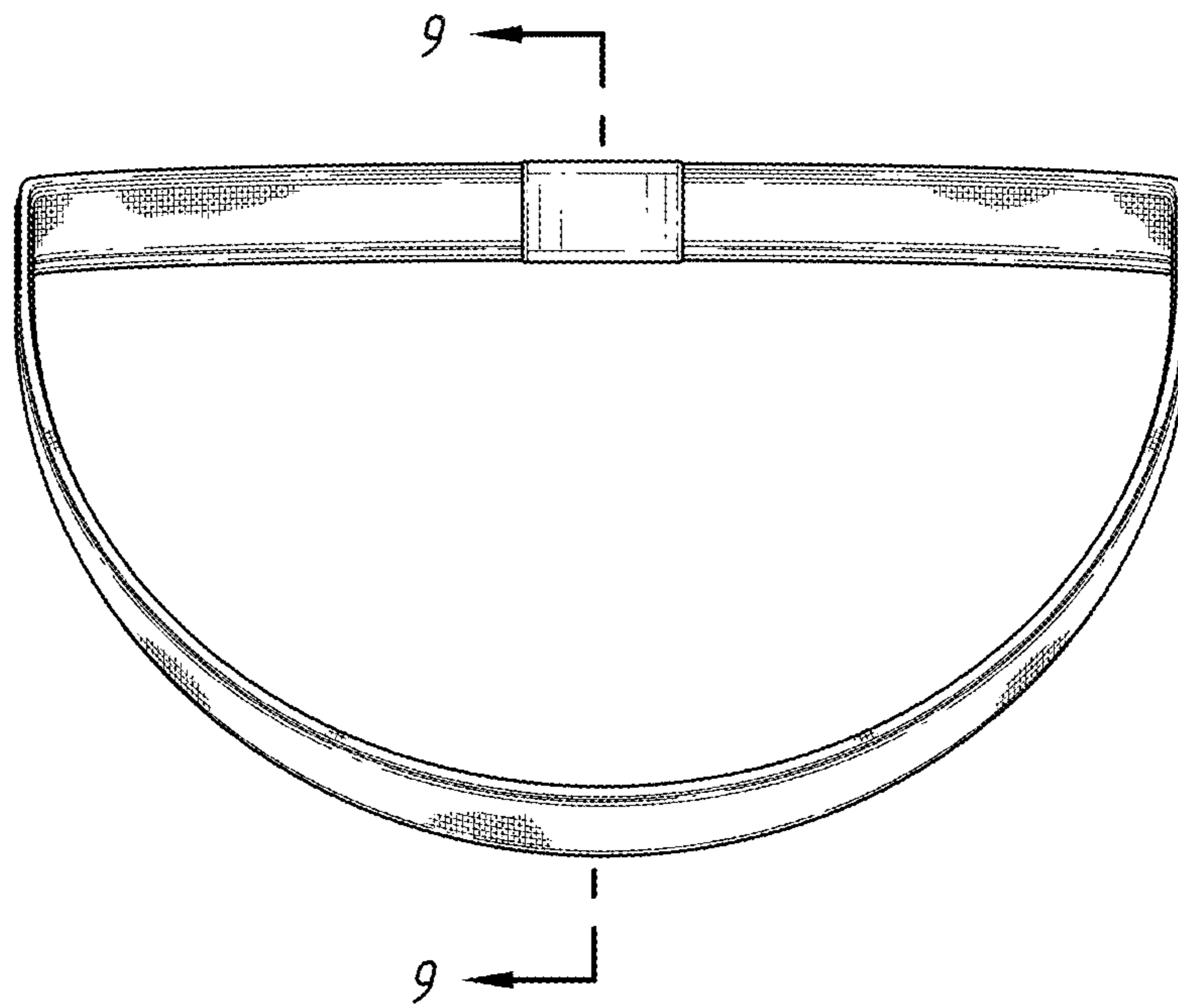

FIG. 7

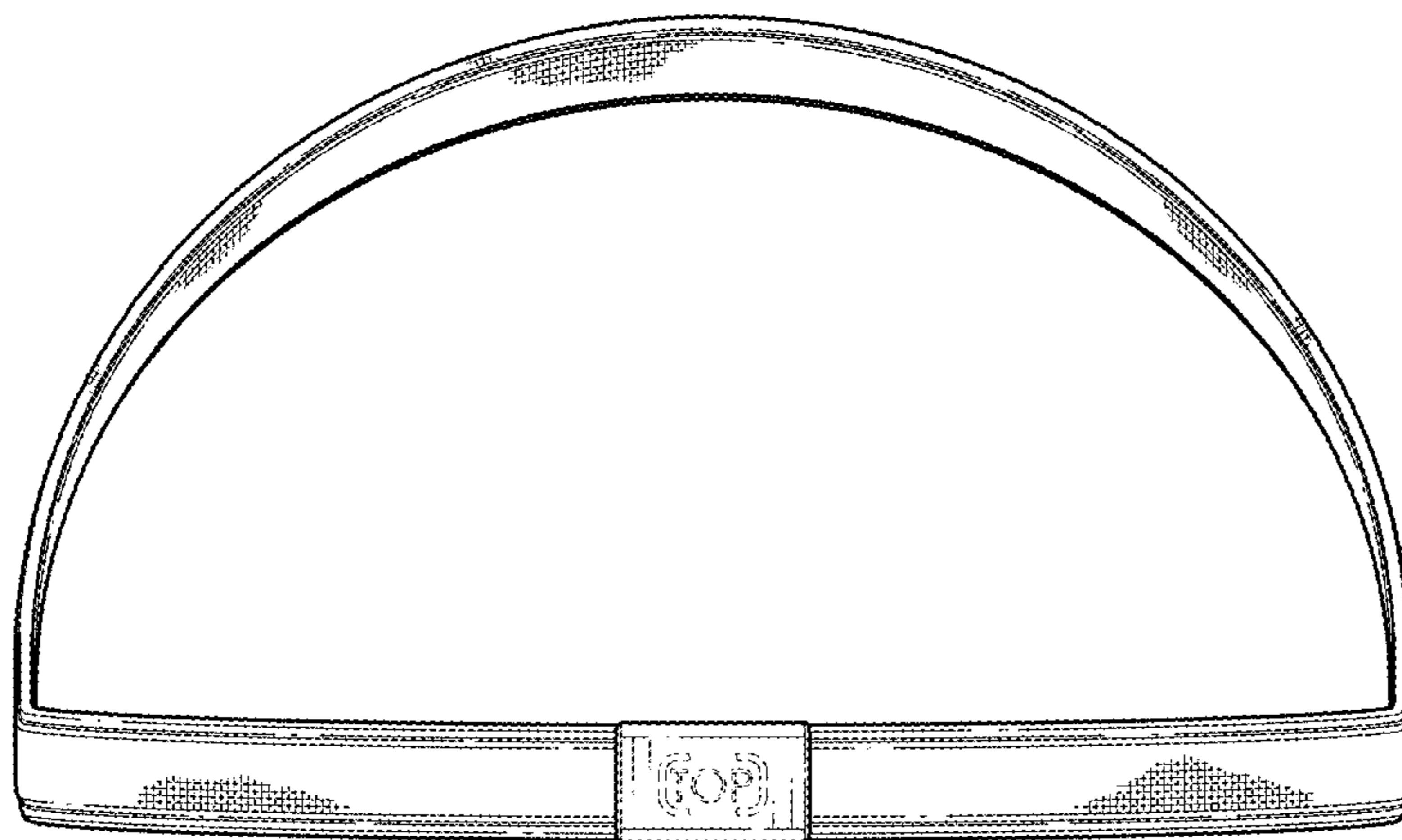

FIG. 8

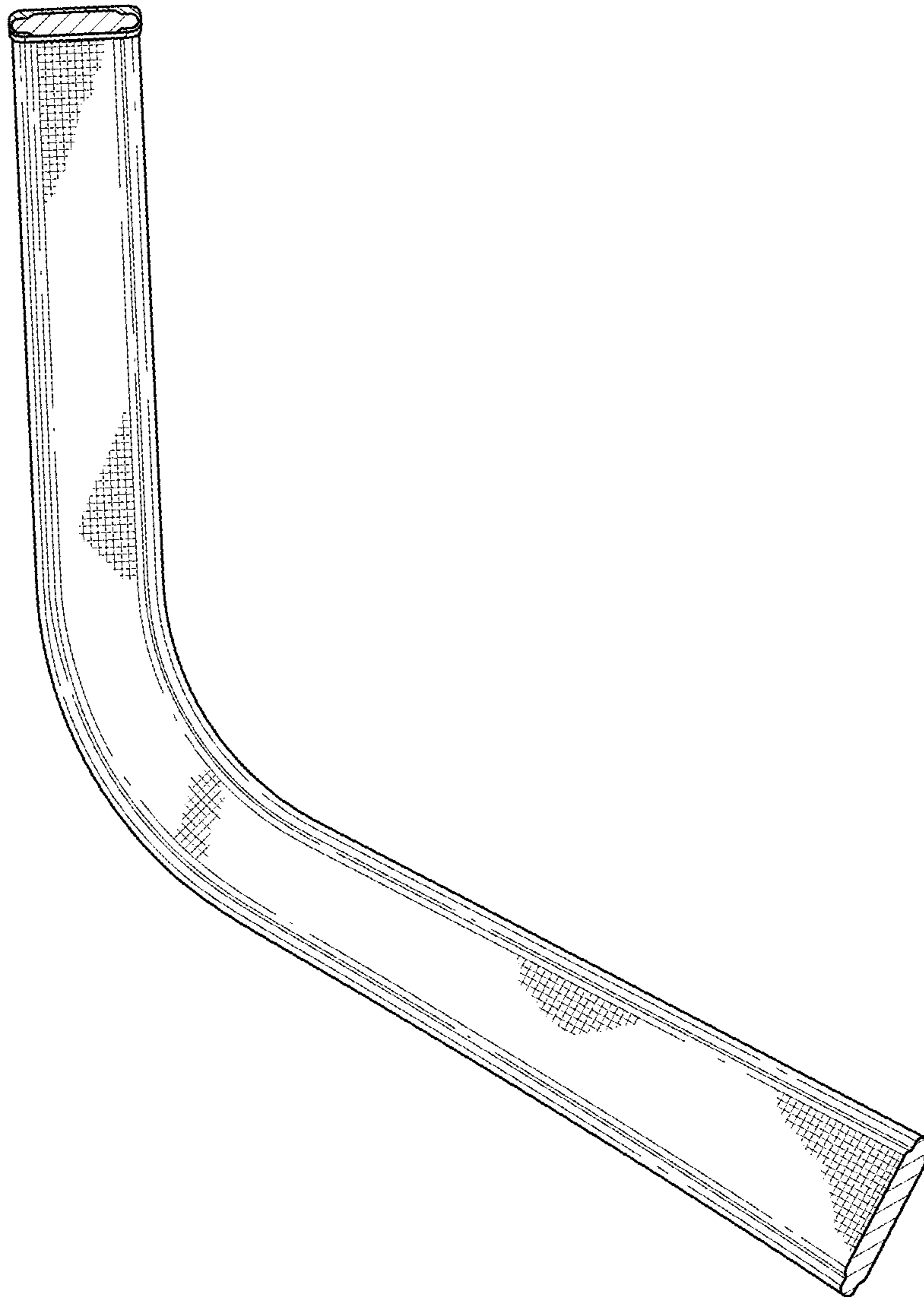

FIG. 9