



US00D875228S

(12) **United States Design Patent** (10) **Patent No.:** **US D875,228 S**
Lee et al. (45) **Date of Patent:** **** Feb. 11, 2020**

- (54) **AIR PURIFIER**
- (71) Applicant: **COWAY CO., LTD.**,
Choongcheongnam-do (KR)
- (72) Inventors: **Sul Ki Lee**, Seoul (KR); **Young Jo Kim**, Seoul (KR)
- (73) Assignee: **Coway Co., Ltd.**, Choongchengnam-do (KR)
- (**) Term: **15 Years**
- (21) Appl. No.: **29/638,461**
- (22) Filed: **Feb. 27, 2018**
- (30) **Foreign Application Priority Data**
Jan. 11, 2018 (KR) 30-2018-0001832
- (51) **LOC (12) Cl.** **23-04**
- (52) **U.S. Cl.**
USPC **D23/366**
- (58) **Field of Classification Search**
USPC D23/208, 355-369; D14/209.1, 212-213
CPC A61L 9/02; A61L 9/03; A61L 9/12; A61L 9/035; A61L 9/125
See application file for complete search history.

(56) **References Cited**

U.S. PATENT DOCUMENTS

D233,435 S	*	10/1974	Kirby	D23/366
D338,522 S	*	8/1993	Muderlak	D23/366
D357,977 S	*	5/1995	Muderlak	D23/366
D363,981 S	*	11/1995	Muderlak	D23/366
D548,825 S	*	8/2007	Suzuki	D23/364
D550,826 S	*	9/2007	Murai	D23/364
D583,450 S	*	12/2008	Choi	D23/364
D595,824 S	*	7/2009	Ohta	D23/364
D595,825 S	*	7/2009	Ohta	D23/364
D595,826 S	*	7/2009	Ohta	D23/364
D599,896 S	*	9/2009	Choi	D23/364

D603,496 S	*	11/2009	Murai	D23/364
D603,497 S	*	11/2009	Choi	D23/364
D604,401 S	*	11/2009	Chun	D23/359
D605,272 S	*	12/2009	Chun	D23/359
D625,398 S	*	10/2010	Choi	D23/364
D634,828 S	*	3/2011	Nakamura	D23/355
D643,520 S	*	8/2011	Choi	D23/364
D722,151 S	*	2/2015	Hu	D23/356

(Continued)

OTHER PUBLICATIONS

Homedepot.com, Honeywell True HEPA 465 sq ft Air Purifier, online product page, reviews dated Mar. 2014, retrieved Sep. 3, 2019 from <URL:https://www.homedepot.com/p/Honeywell-True-HEPA-465-sq-ft-Air-Purifier-Allergen-Remover-HA300BHD/204390560> (Year: 2014).*

(Continued)

Primary Examiner — Sheryl Lane

Assistant Examiner — Calvin E Vansant

(74) *Attorney, Agent, or Firm* — Millen, White, Zelano & Branigan, P.C.; William Nixon

(57) **CLAIM**

We claim the ornamental design for an air purifier, as shown and described.

DESCRIPTION

FIG. 1 illustrates a perspective view of an air purifier showing our design;

FIG. 2 illustrates a front elevational view thereof;

FIG. 3 illustrates a rear elevational view thereof;

FIG. 4 is a left side elevational view thereof;

FIG. 5 is a right side elevational view thereof;

FIG. 6 illustrates a top plan view thereof; and,

FIG. 7 illustrates a bottom plan view thereof.

The broken lines in the drawings illustrate environmental portions of the air purifier which form no part of the claimed design.

1 Claim, 7 Drawing Sheets

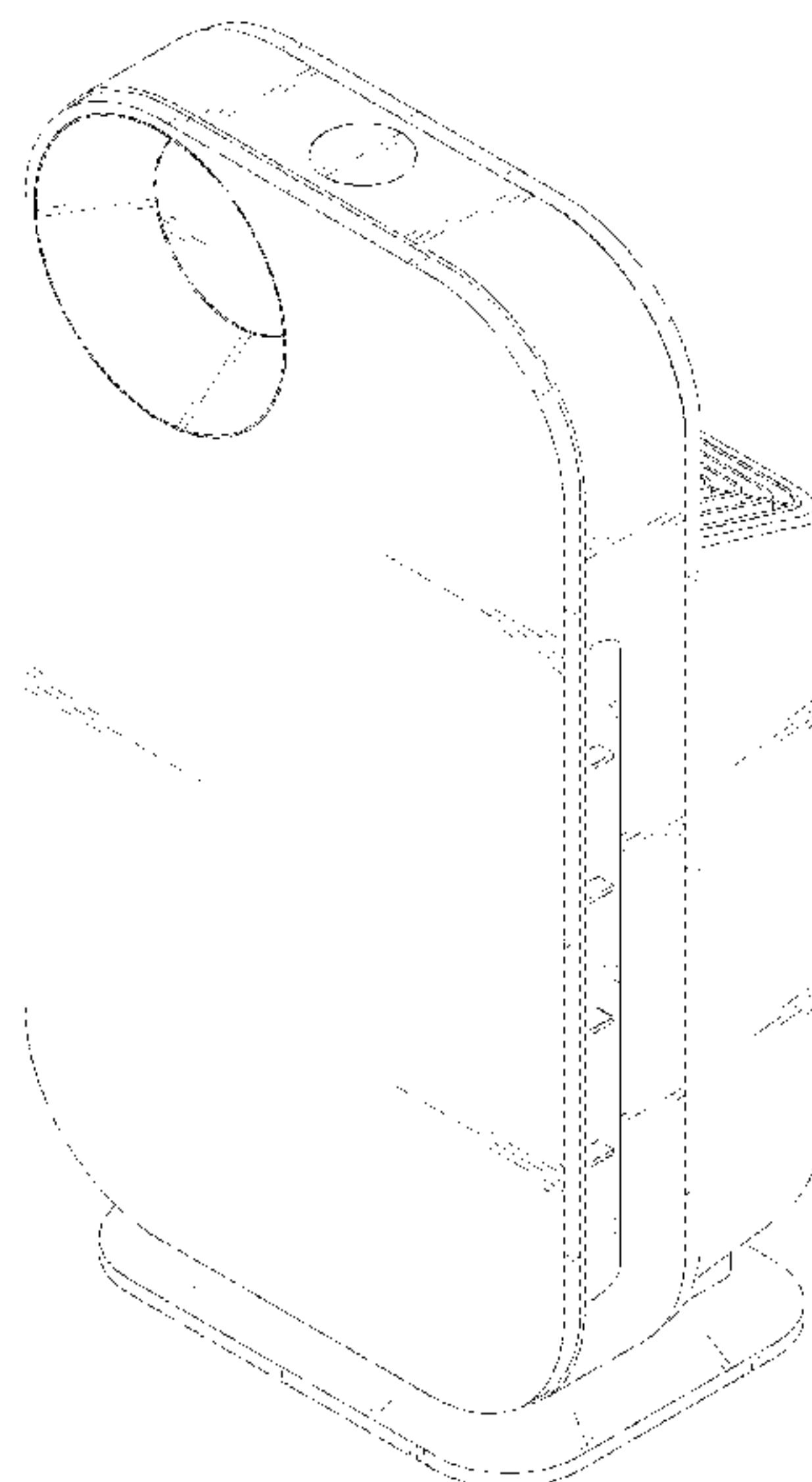

(56)

References Cited

U.S. PATENT DOCUMENTS

D722,152 S *	2/2015	Hu	D23/356
D722,153 S *	2/2015	Hu	D23/364
D731,633 S *	6/2015	Farone	D23/364
D799,015 S *	10/2017	Tang	D23/364
D801,502 S *	10/2017	Hu	D23/355
D804,001 S *	11/2017	Cartwright	D23/355
D807,997 S *	1/2018	Seo	D23/364
D810,906 S *	2/2018	Yoon	D23/364
D830,528 S *	10/2018	Zhou	D23/364
D832,988 S *	11/2018	Stoner, Jr.	D23/355
D835,764 S *	12/2018	Farone	D23/364
D846,105 S *	4/2019	Stoner, Jr.	D23/355

OTHER PUBLICATIONS

Youtube.com, Coway AP 1008CH, product review video, Feb. 2012, retrieved from <URL:<https://www.youtube.com/watch?v=88eKHWFEb10>> (Year: 2012).*

* cited by examiner

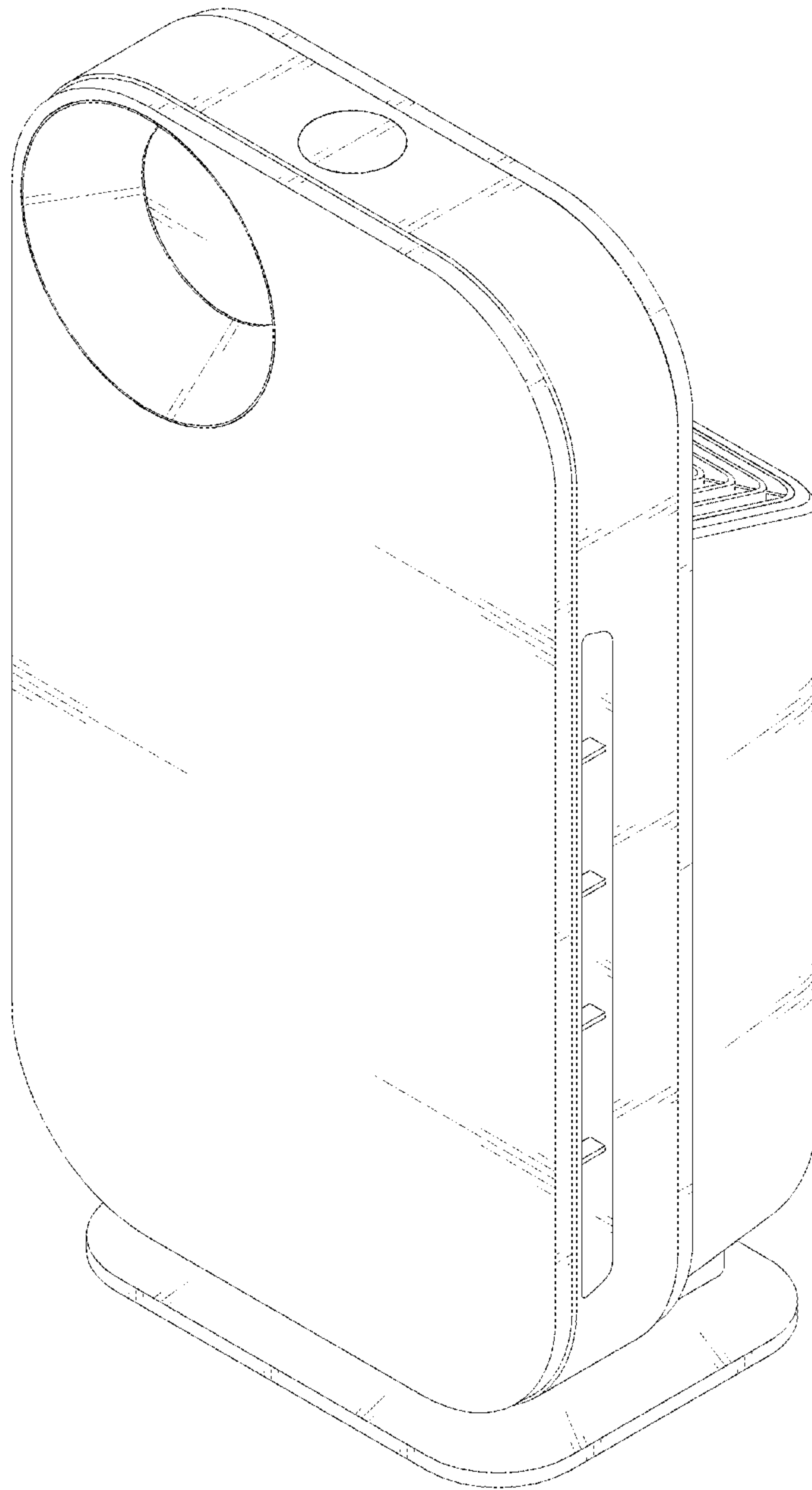

FIG. 1

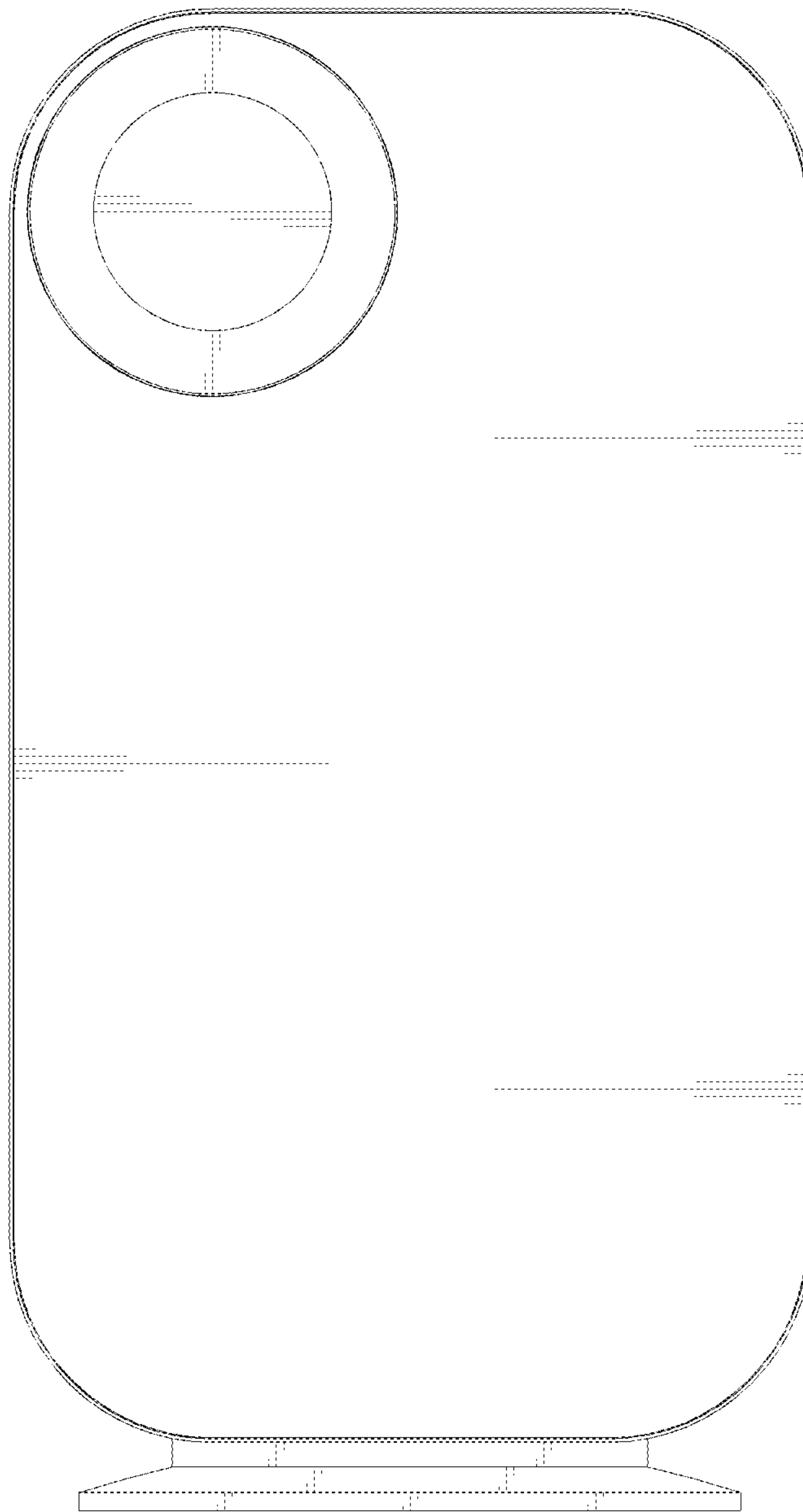

FIG. 2

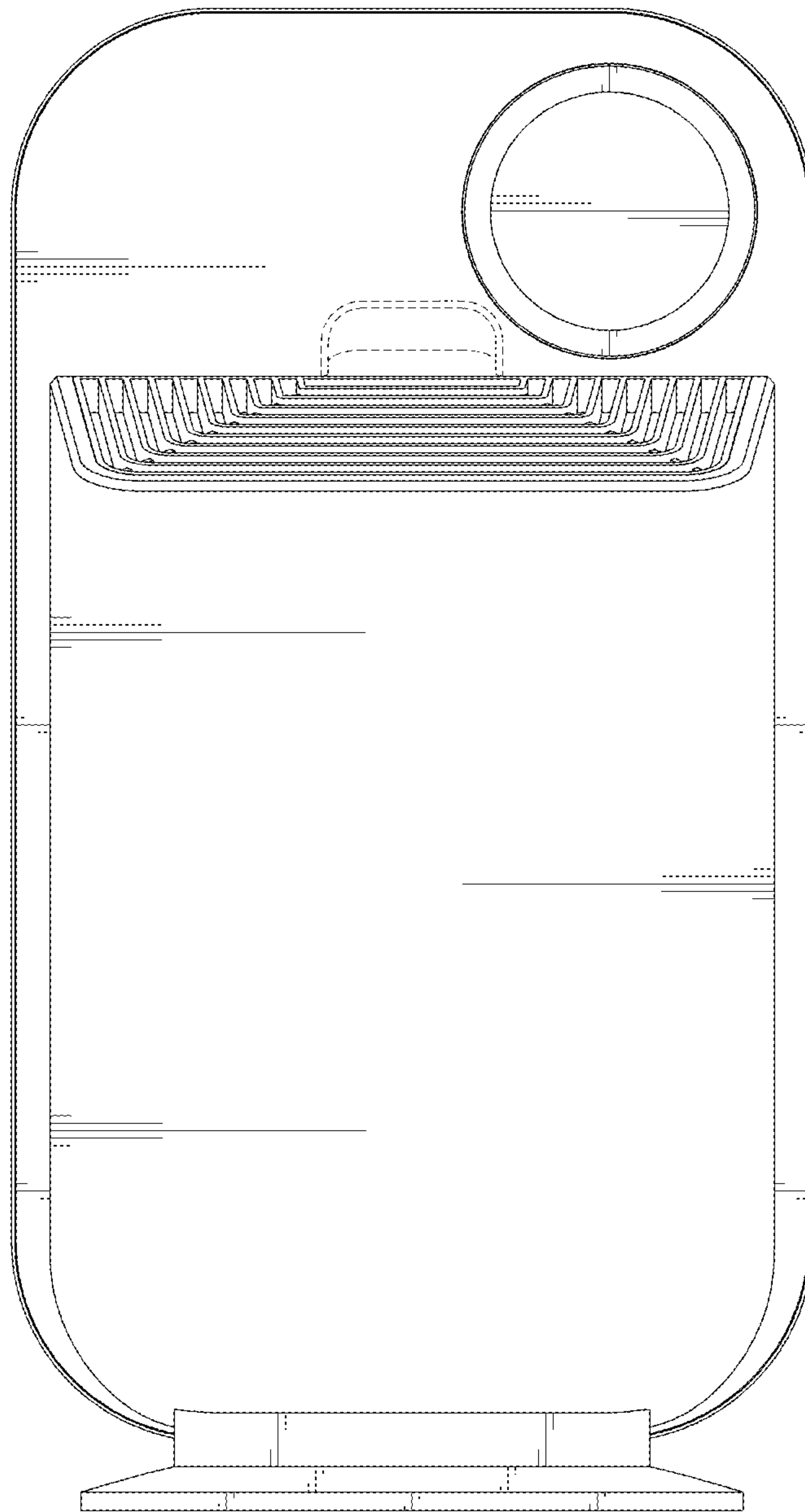

FIG. 3

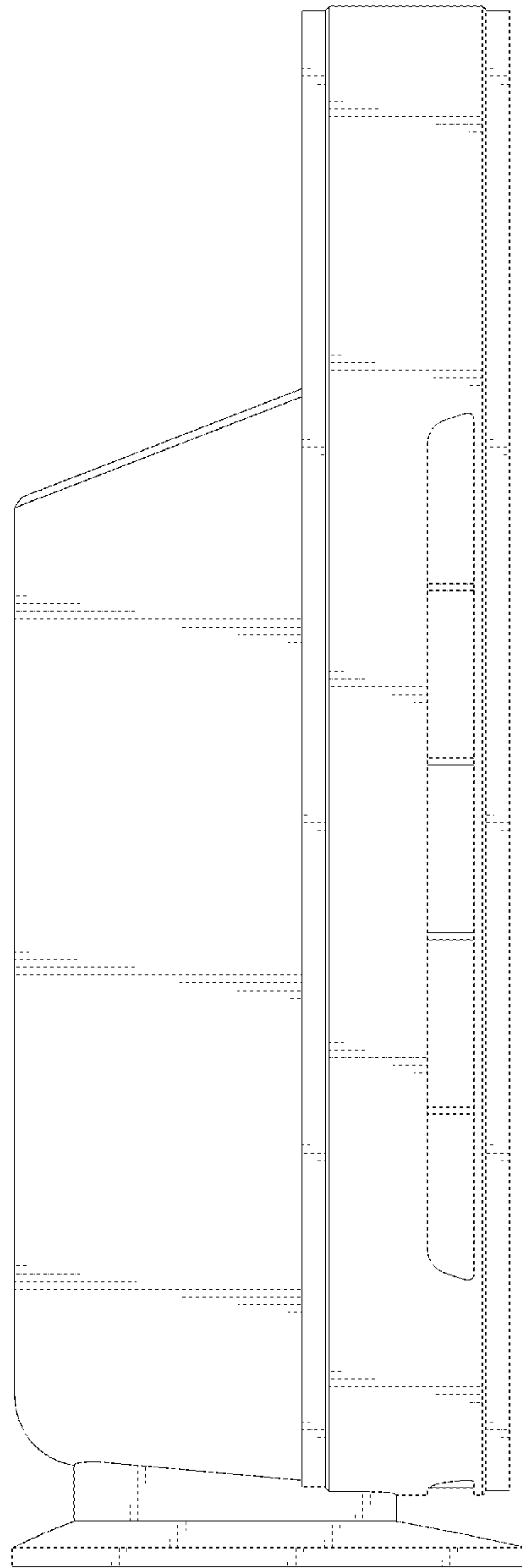

FIG. 4

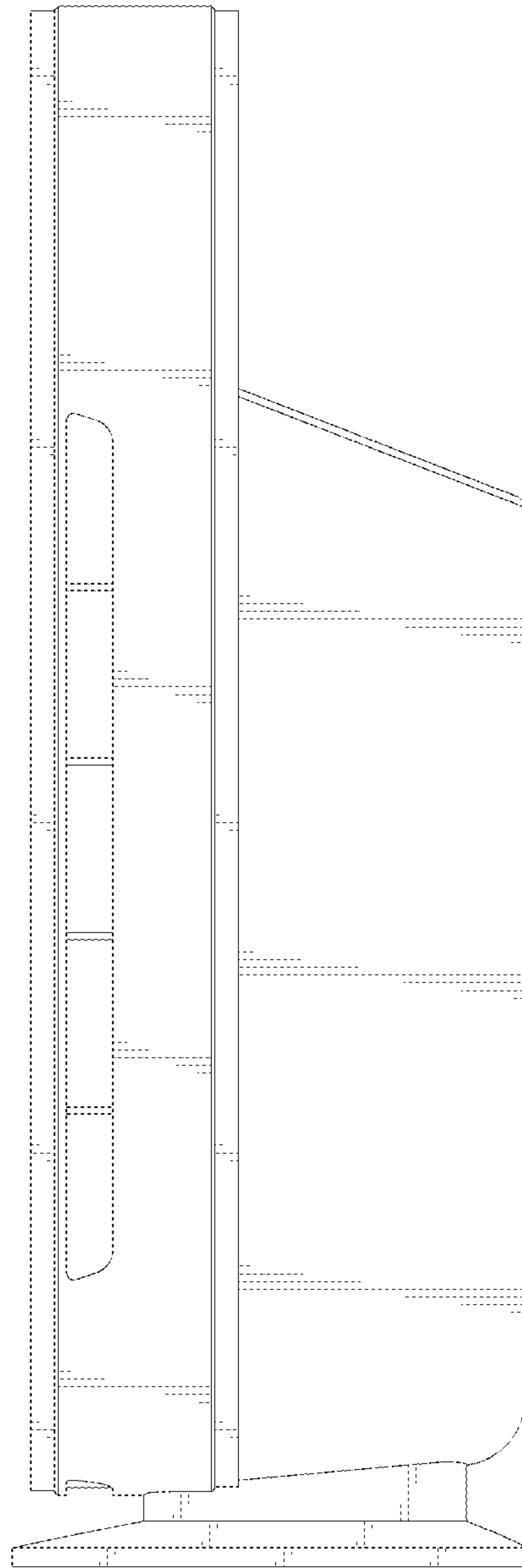

FIG. 5

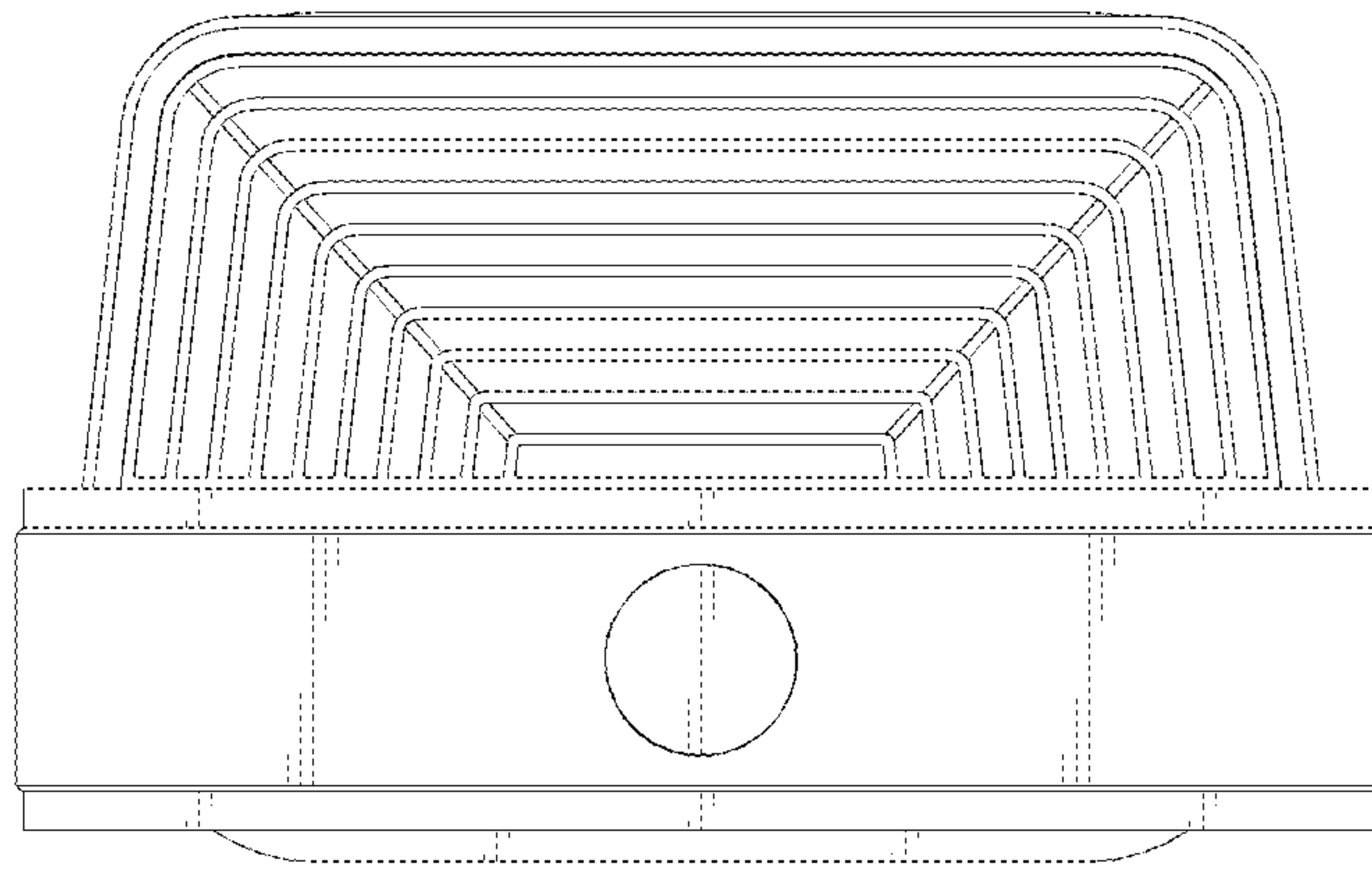

FIG. 6

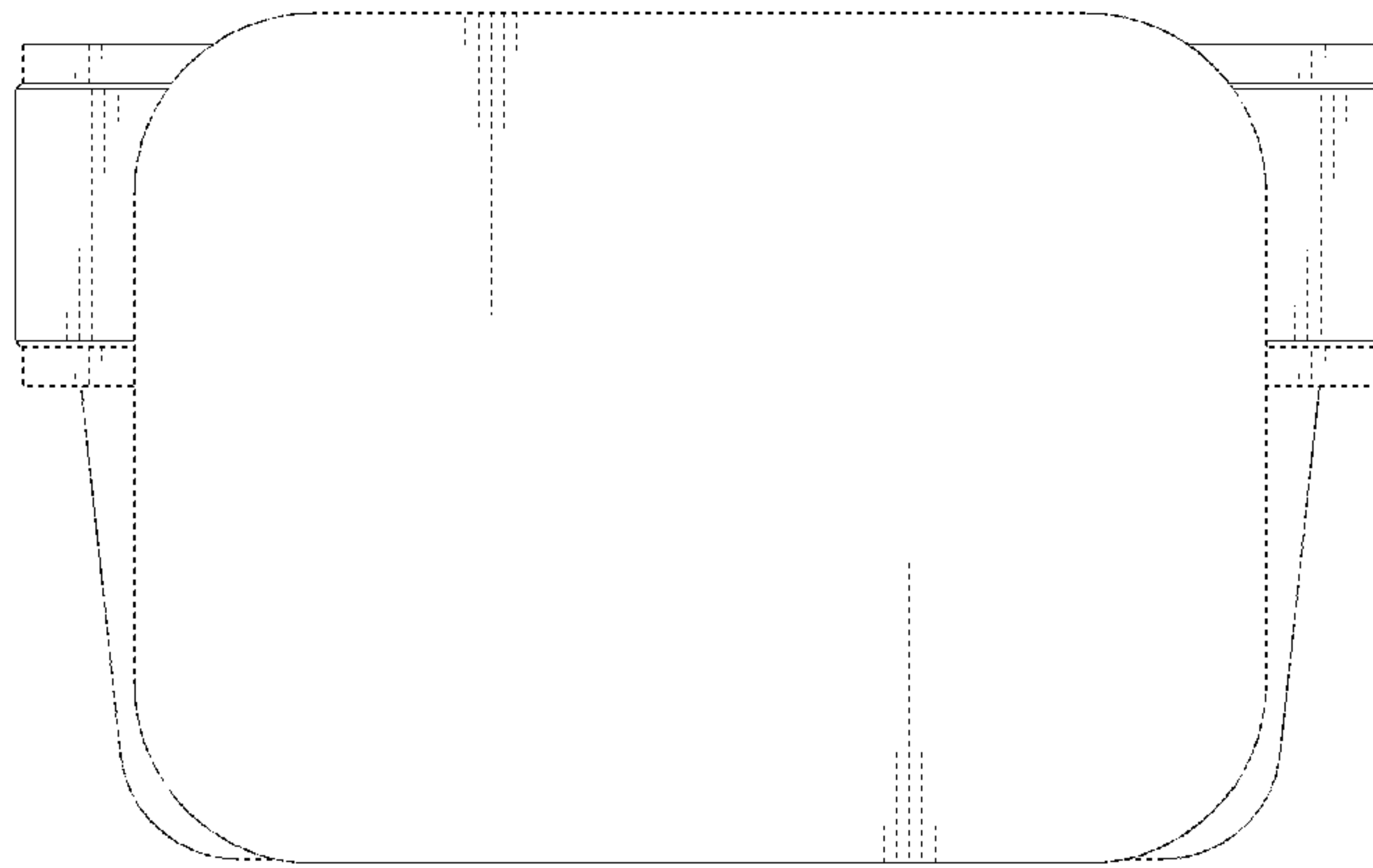

FIG. 7