



US00D875093S

(12) **United States Design Patent**
Park

(10) **Patent No.:** **US D875,093 S**

(45) **Date of Patent:** **** Feb. 11, 2020**

(54) **HEAD MOUNT DISPLAY**

(71) Applicant: **Samsung Electronics Co., Ltd.**,
Suwon-si (KR)

(72) Inventor: **Junghyun Park**, Seoul (KR)

(73) Assignee: **SAMSUNG ELECTRONICS CO., LTD.**,
Gyeonggi-Do (KR)

(**) Term: **15 Years**

(21) Appl. No.: **29/644,033**

(22) Filed: **Apr. 13, 2018**

(30) **Foreign Application Priority Data**

Oct. 16, 2017 (KR) 30-2017-0047891

(51) **LOC (12) Cl.** **14-02**

(52) **U.S. Cl.**
USPC **D14/372**

(58) **Field of Classification Search**
USPC D14/372, 496, 432, 371, 125, 126, 129,
D14/299; D16/300-342; 351/158, 153,
351/144; 345/7-9, 905; 455/344;
348/115, 53, 121, 739
CPC G02B 27/017; G02B 27/0158; G02B
27/0161; G02B 27/0181; G02B 27/0185;
G02B 27/0189

See application file for complete search history.

(56) **References Cited**

U.S. PATENT DOCUMENTS

D778,909 S * 2/2017 Nokuo D14/372
D785,619 S * 5/2017 Su D14/372

D807,354 S * 1/2018 Yee D14/372
D810,743 S * 2/2018 Yee D14/372
D819,634 S * 6/2018 Pang D14/372
D819,635 S * 6/2018 Miller D14/372
D819,636 S * 6/2018 Chen D14/372
D827,642 S * 9/2018 Liu D14/372
D834,016 S * 11/2018 Raffle D14/372
D860,200 S * 9/2019 McGinty, Jr. D14/372

* cited by examiner

Primary Examiner — Austin Murphy

(74) *Attorney, Agent, or Firm* — Cantor Colburn LLP

(57) **CLAIM**

The ornamental design for a head mount display, as shown and described.

DESCRIPTION

FIG. 1 is a front perspective view of a first embodiment of a head mount display, showing our new design;
FIG. 2 is a front view thereof;
FIG. 3 is a rear view thereof;
FIG. 4 is a left-side view thereof;
FIG. 5 is a right-side view thereof;
FIG. 6 is a top view thereof;
FIG. 7 is a bottom view thereof;
FIG. 8 is a front perspective view of a second embodiment of a head mount display, showing our new design;
FIG. 9 is a front view thereof;
FIG. 10 is a rear view thereof;
FIG. 11 is a left-side view thereof;
FIG. 12 is a right-side view thereof;
FIG. 13 is a top view thereof; and,
FIG. 14 is a bottom view thereof.
The broken lines illustrating portions of the head mount display form no part of the claimed design.

1 Claim, 10 Drawing Sheets

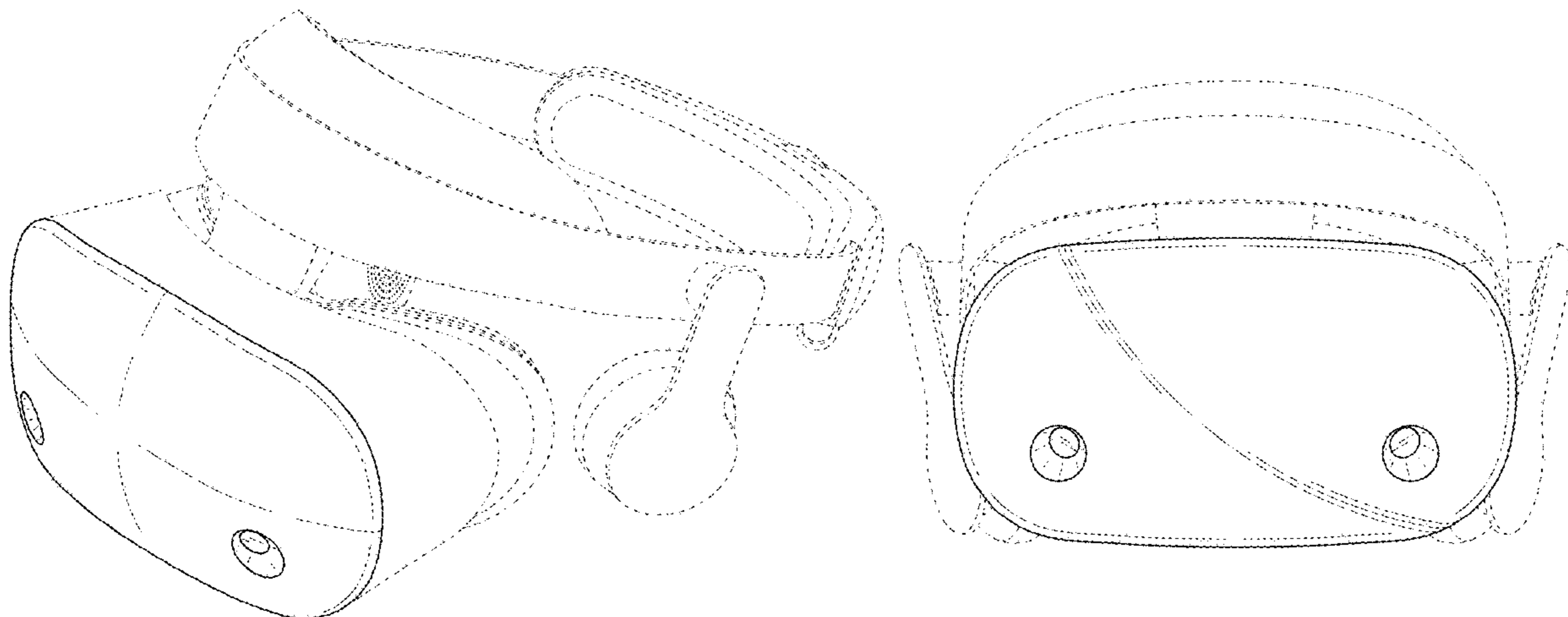

FIG.1

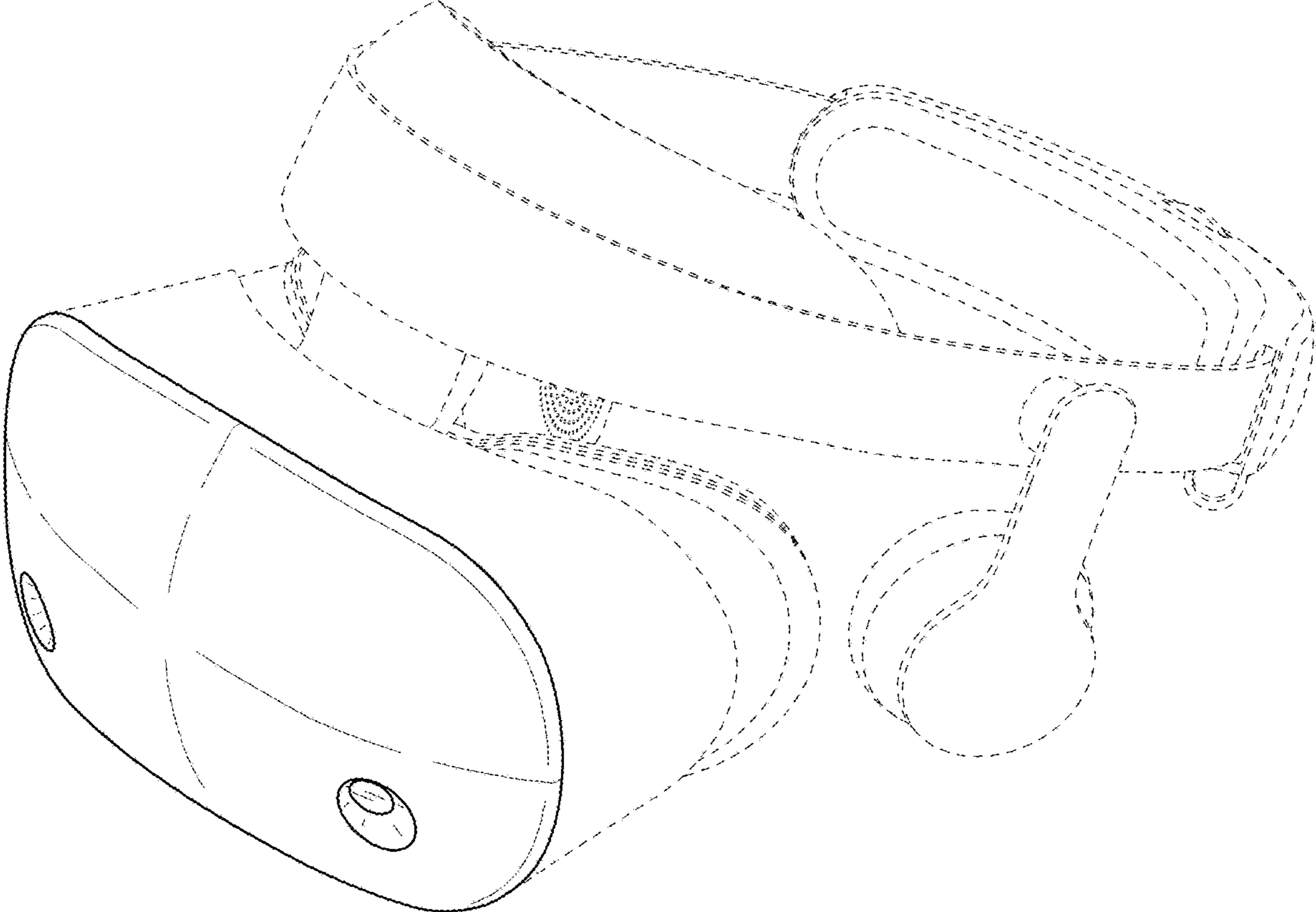

FIG.2

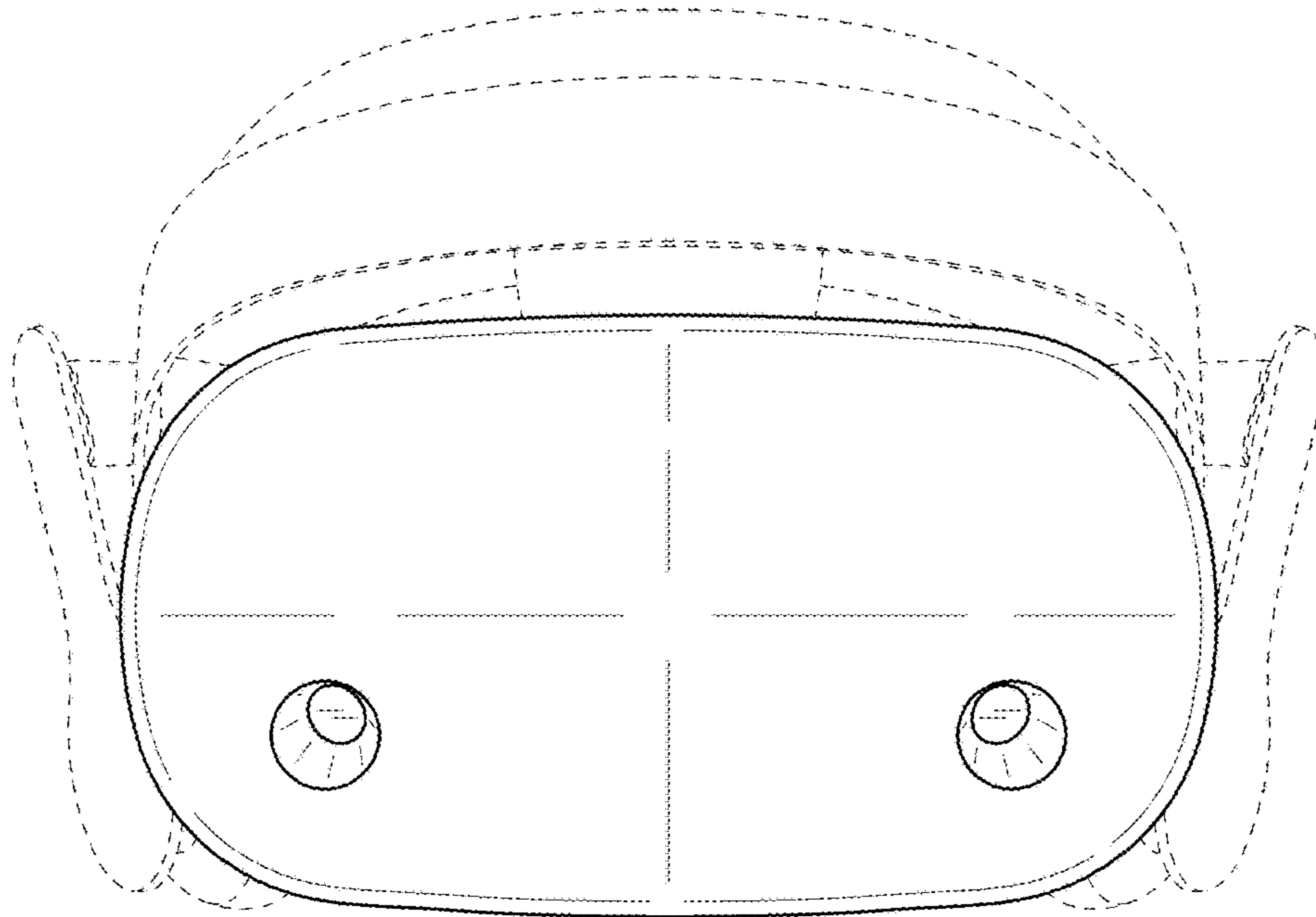

FIG.3

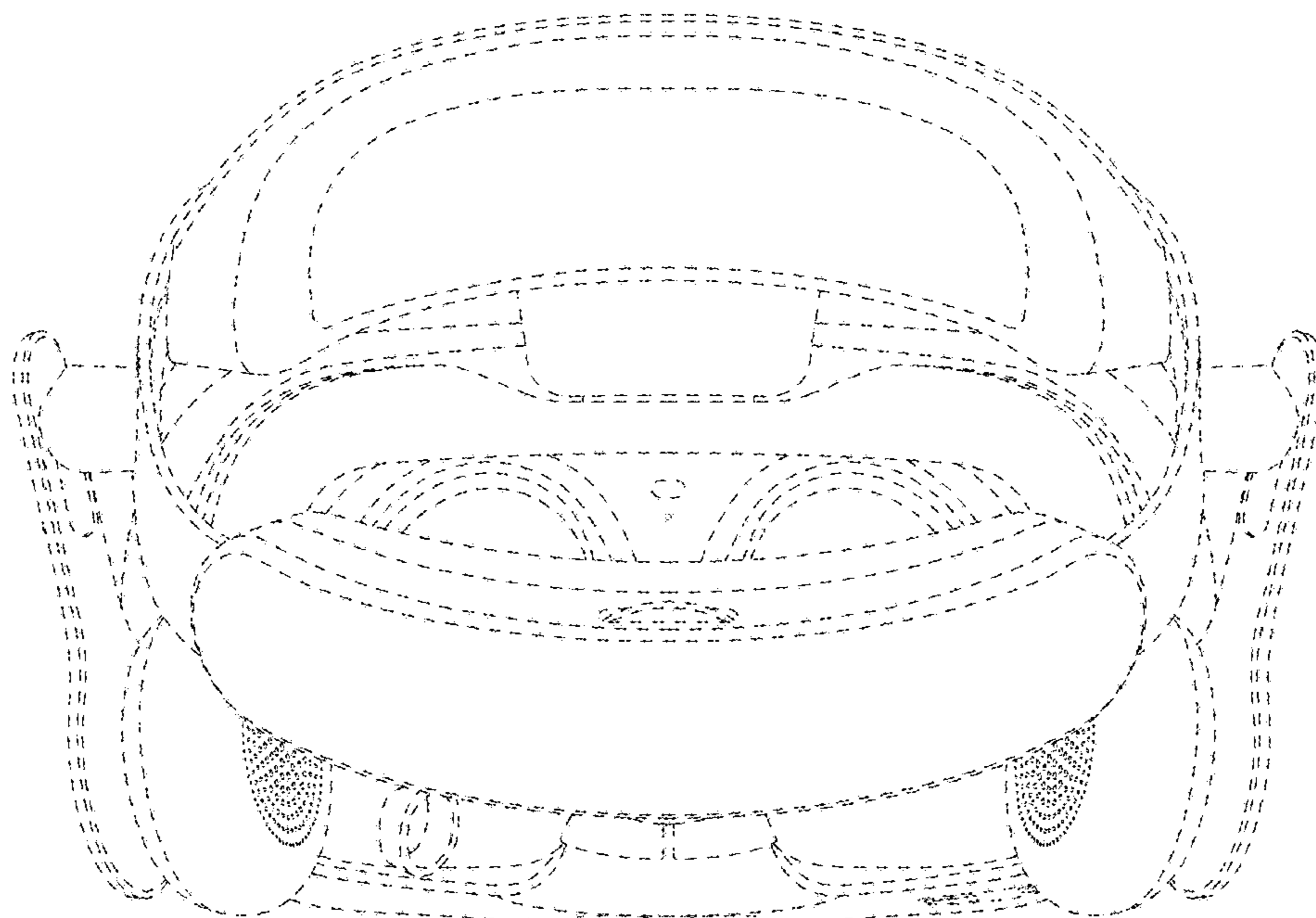

FIG.4

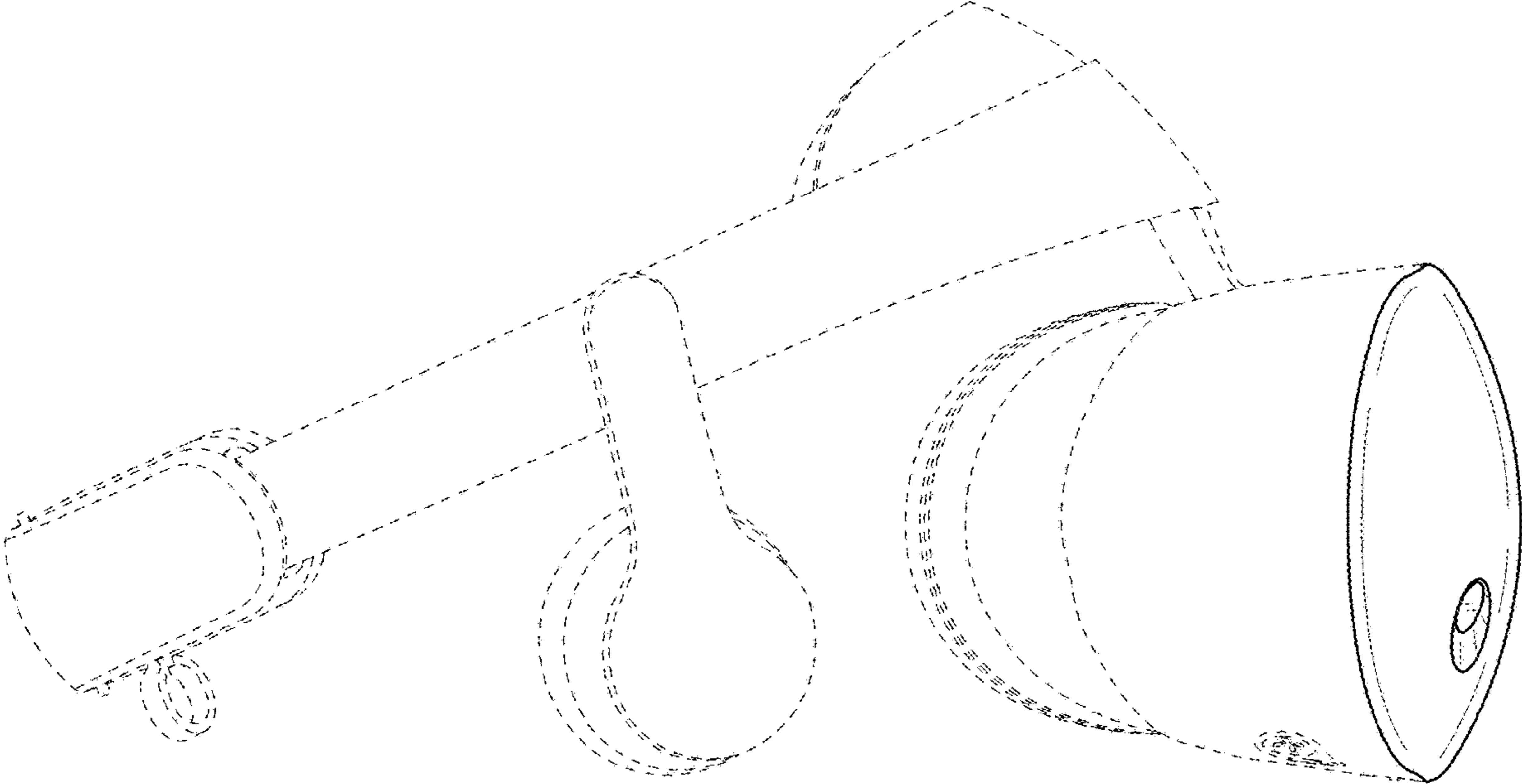

FIG.5

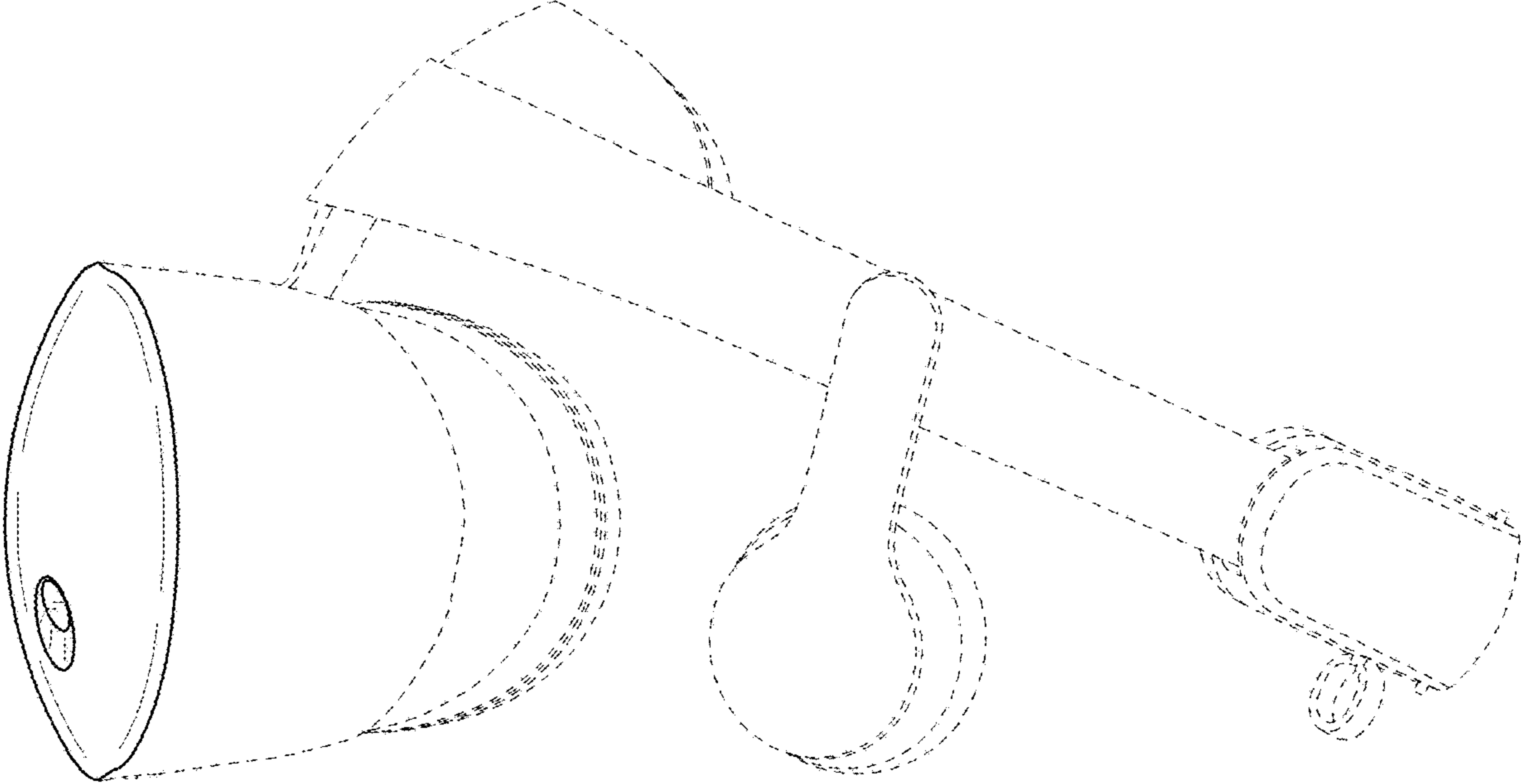

FIG.6

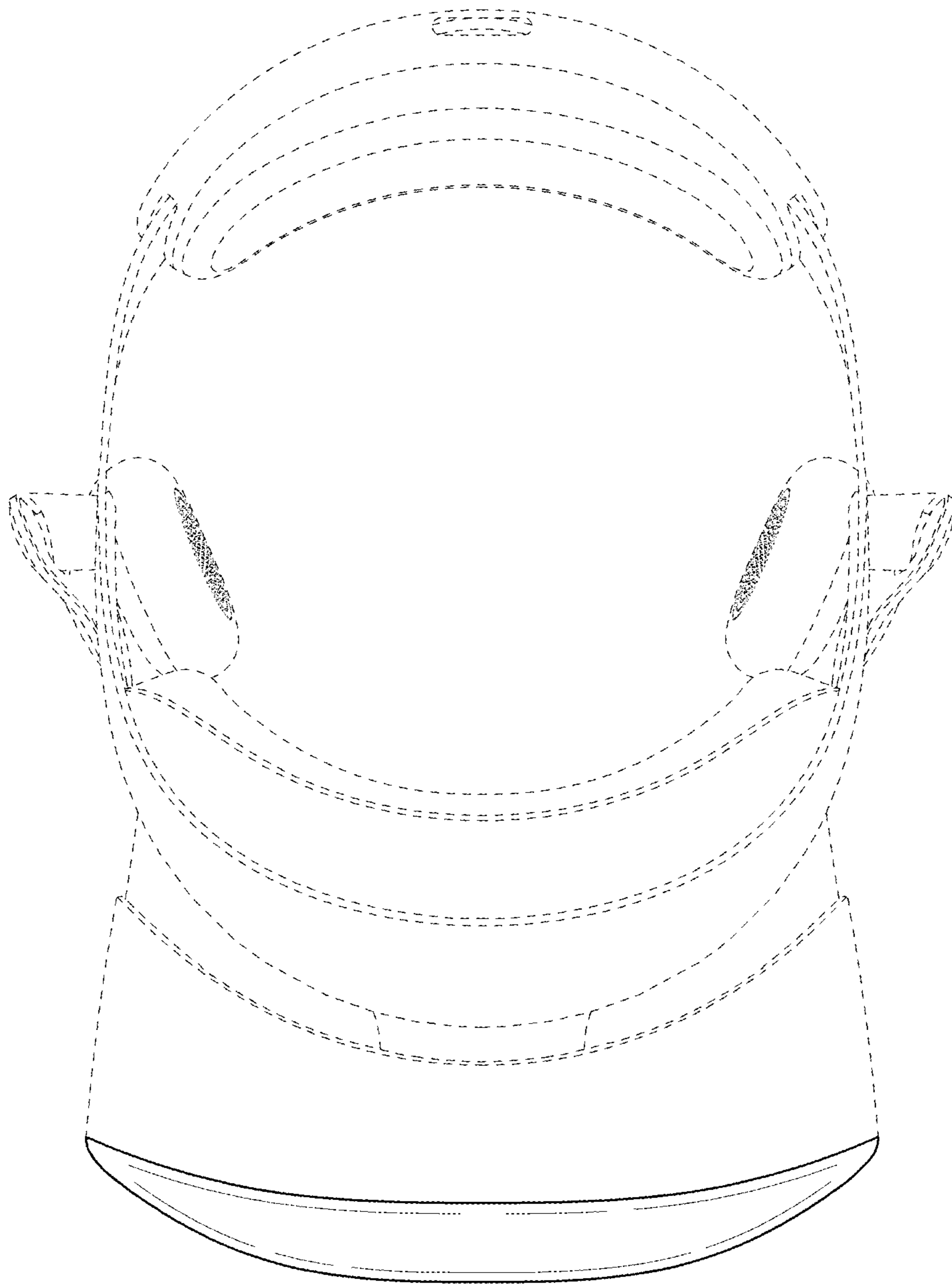

FIG.7

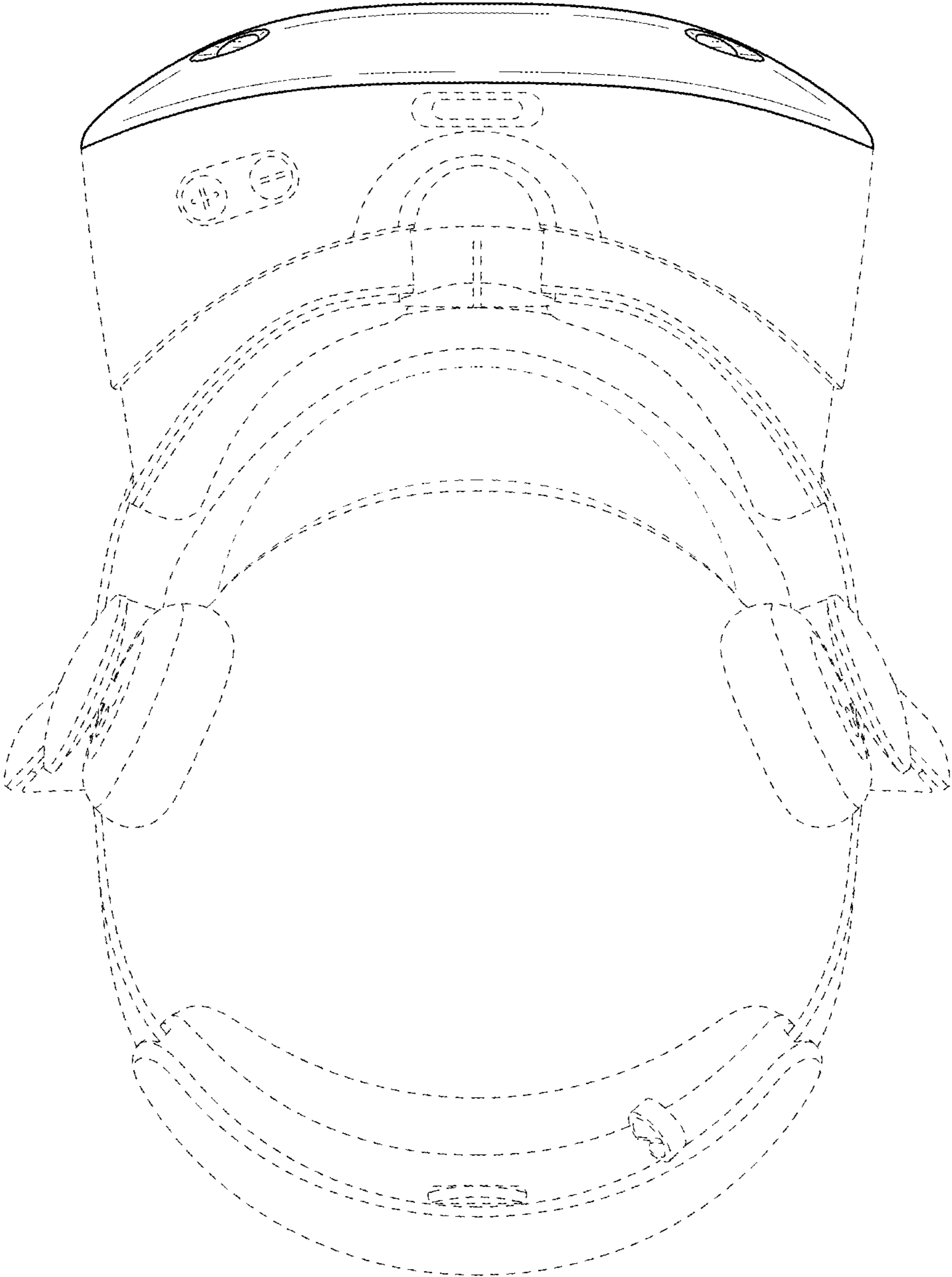

FIG.8

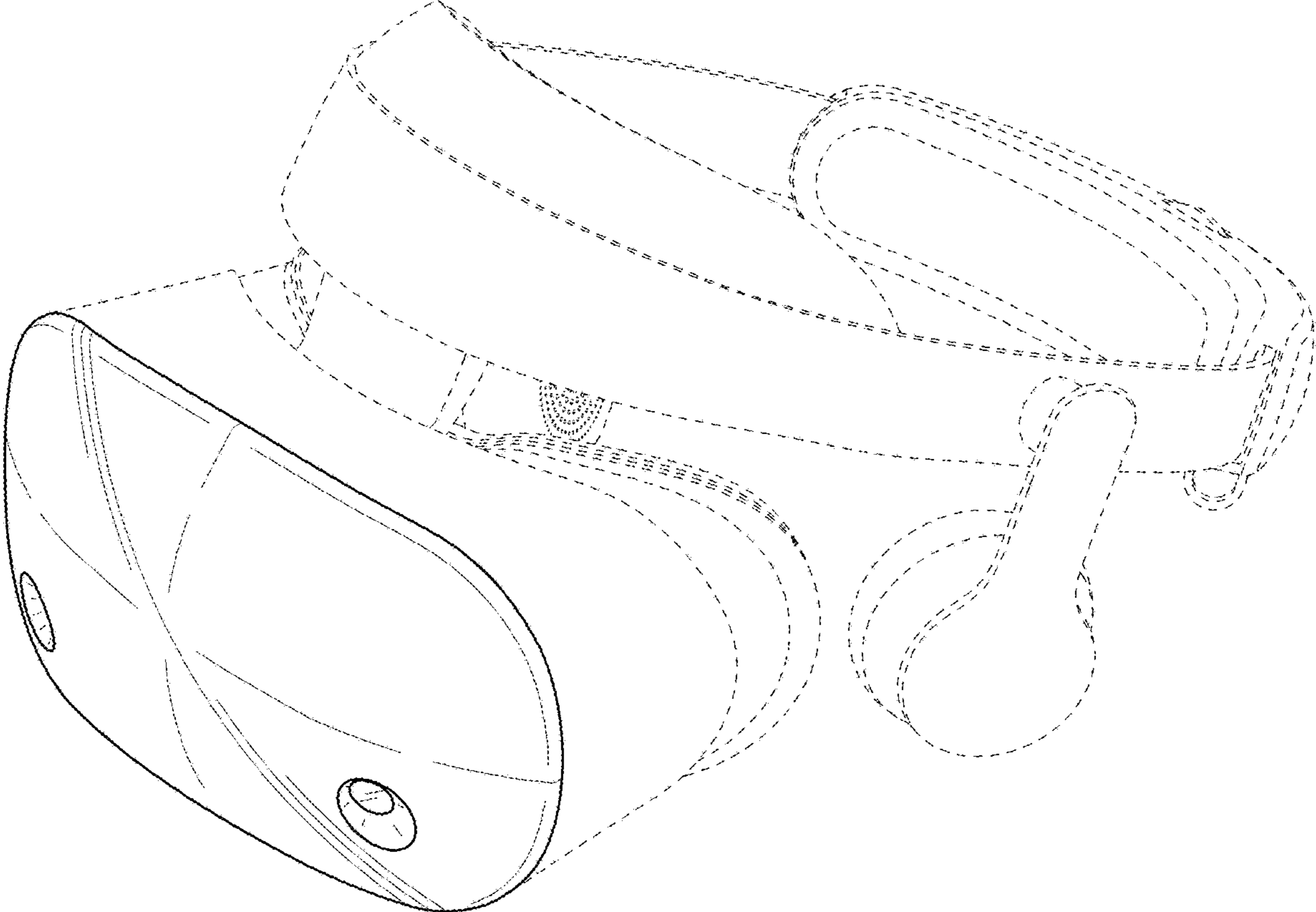

FIG.9

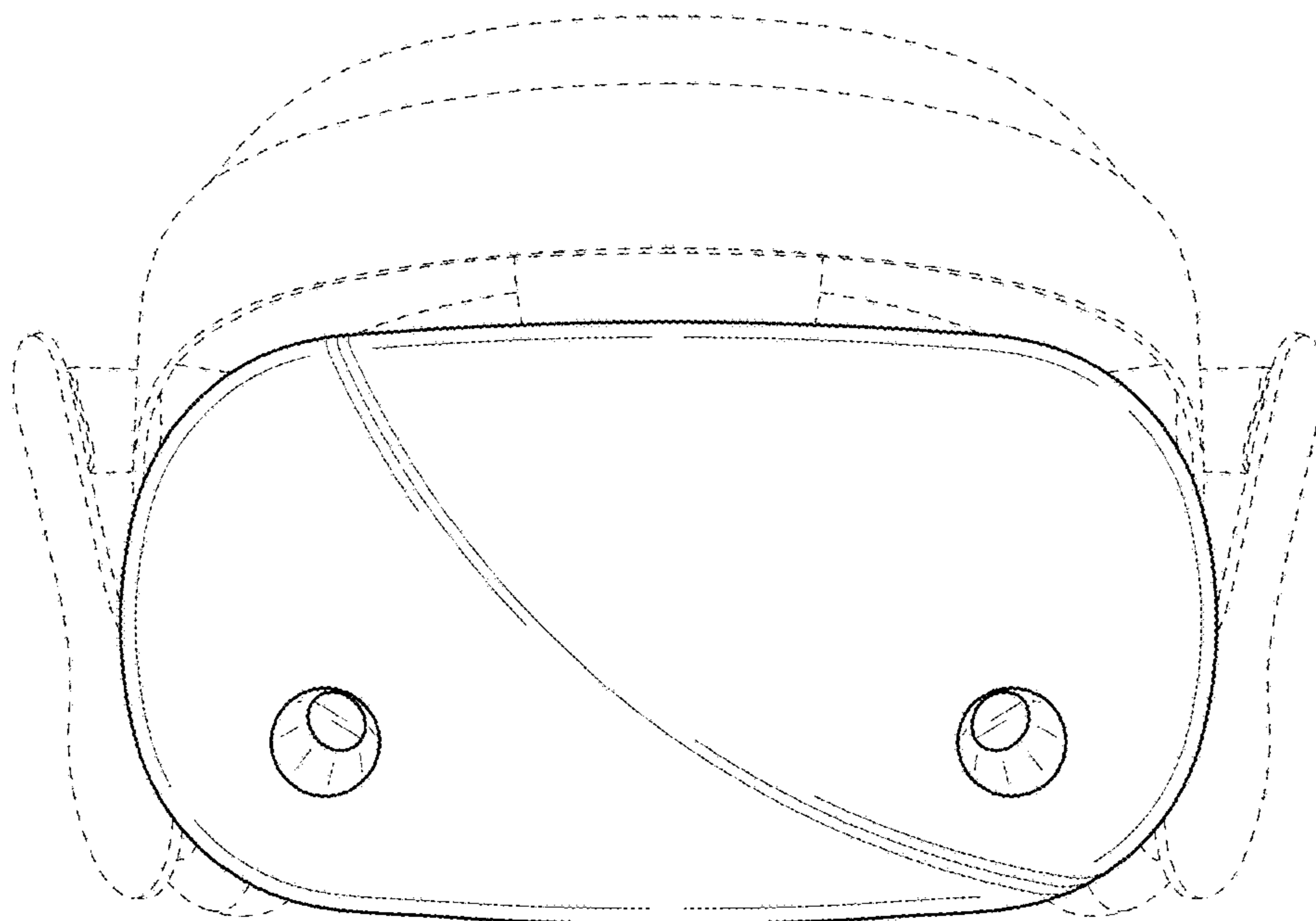

FIG.10

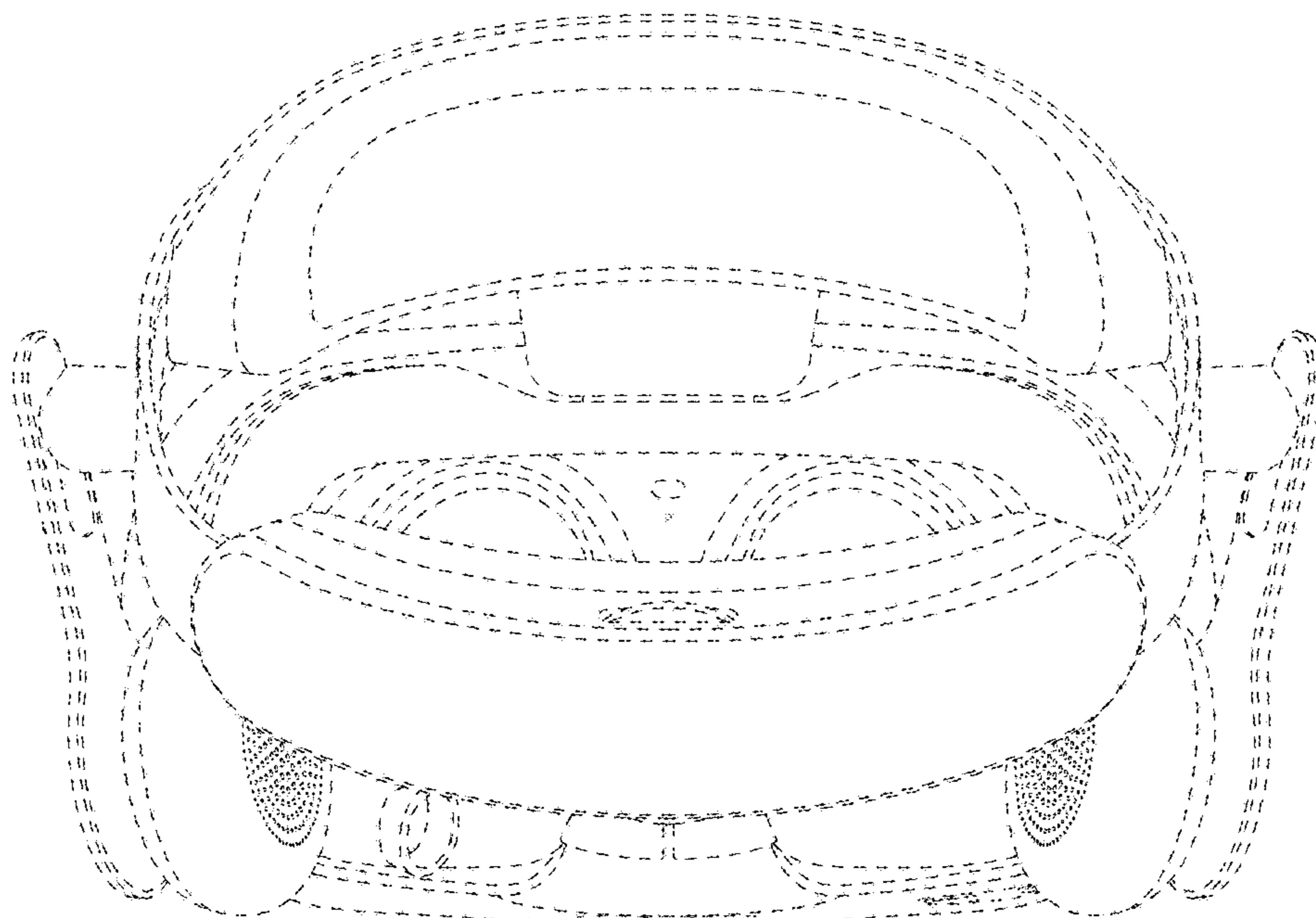

FIG.11

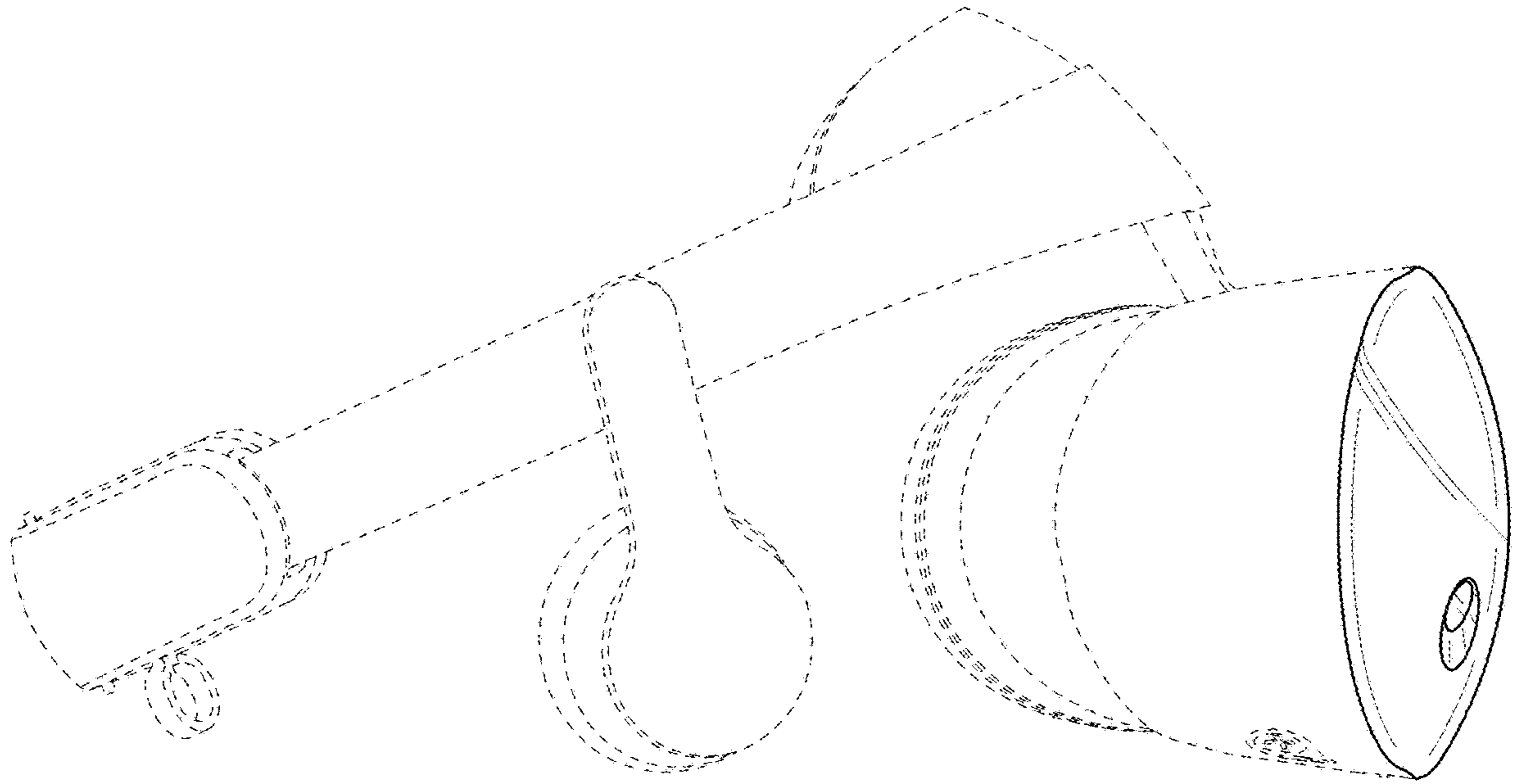

FIG.12

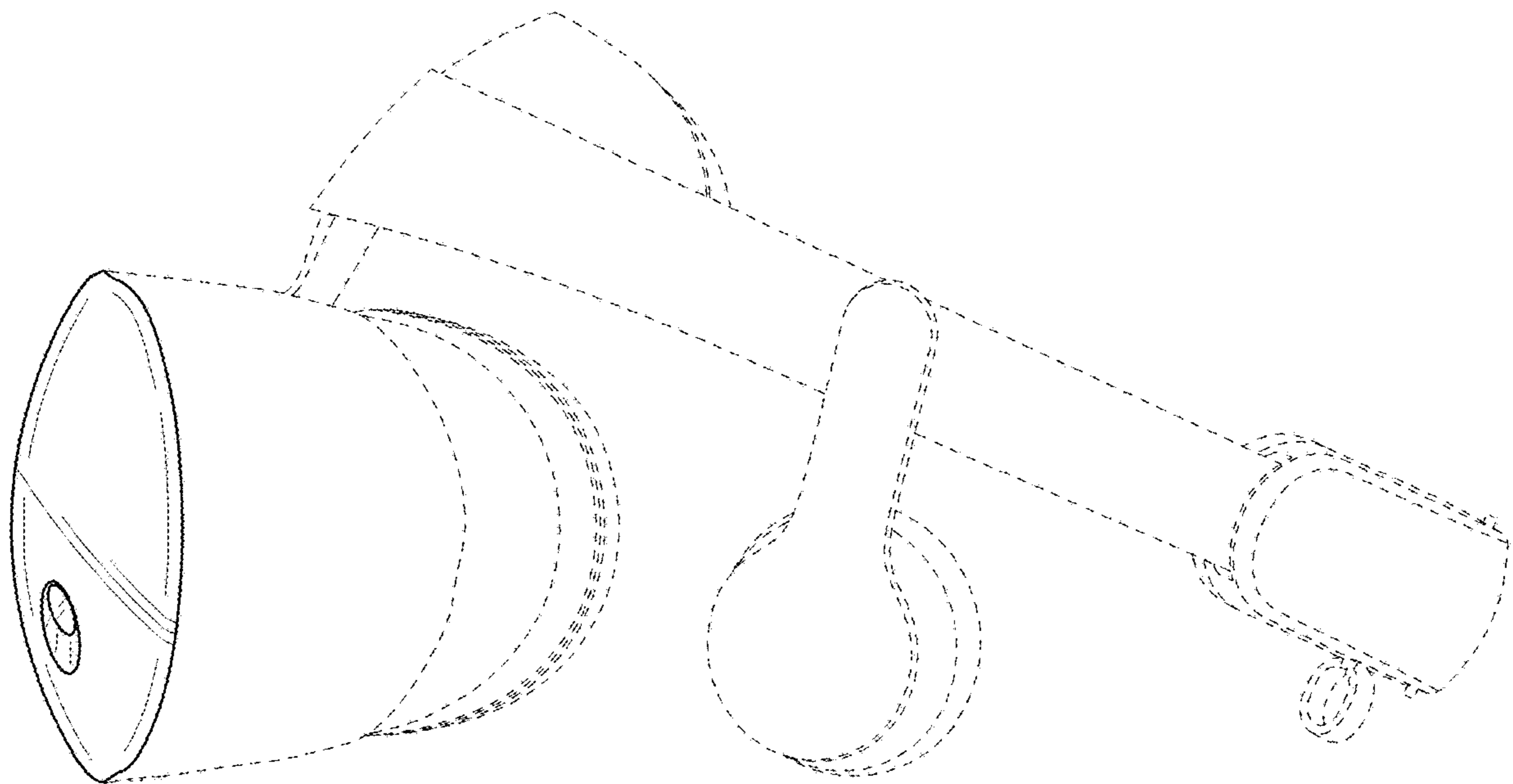

FIG. 13

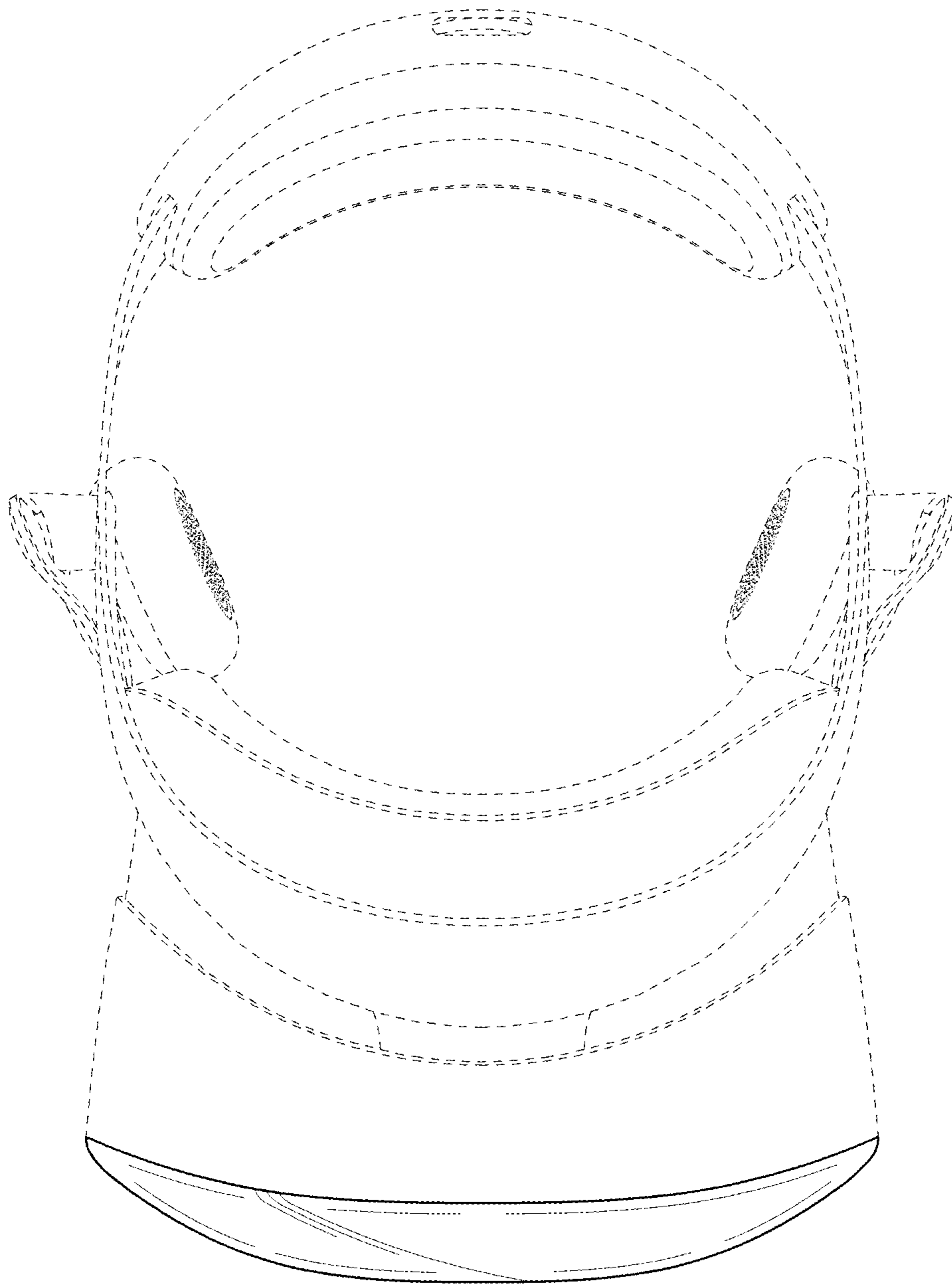

FIG.14

