



US00D874756S

(12) **United States Design Patent**  
**Tamar et al.**

(10) **Patent No.:** **US D874,756 S**

(45) **Date of Patent:** **\*\* Feb. 4, 2020**

(54) **POOL CLEANER WITH REAR THRUSTERS**

(71) Applicant: **MAYTRONICS LTD.**, Kibbutz Yizrael (IL)

(72) Inventors: **Yaniv Tamar**, Gan Ner (IL);  
**Jackov-Guy Ben-Simon**, Yokneam (IL)

(73) Assignee: **MAYTRONICS LTD.** (IL)

(\*\*) Term: **15 Years**

(21) Appl. No.: **29/606,039**

(22) Filed: **Jun. 1, 2017**

(51) **LOC (12) Cl.** ..... **15-05**

(52) **U.S. Cl.**  
USPC ..... **D32/15**

(58) **Field of Classification Search**  
USPC ..... 15/1.7; 210/416.2, 167.16, 167.15;  
D32/18, 21, 32-33  
CPC ... E04H 4/1609; E04H 4/1654; E04H 4/1663;  
E04H 4/1672; E04H 4/169; E04H 4/1636  
See application file for complete search history.

(56) **References Cited**

**U.S. PATENT DOCUMENTS**

3,074,087	A *	1/1963	Drennan	.....	E04H 4/1636
					15/1.7
D376,450	S *	12/1996	Campbell	.....	D32/21
D421,512	S *	3/2000	Campbell	.....	D32/21
D443,737	S *	6/2001	Rief	.....	D32/15
D469,589	S *	1/2003	Wichmann	.....	D32/21
D471,330	S *	3/2003	Campbell	.....	D32/21
D630,809	S *	1/2011	Dye	.....	D32/21
8,341,789	B2 *	1/2013	Garti	.....	E04H 4/1654
					15/1.7
8,771,504	B2 *	7/2014	Mastio	.....	E04H 4/1654
					15/1.7
D721,460	S *	1/2015	Hanan	.....	D32/21
9,222,275	B2 *	12/2015	Ben Dov	.....	E04H 4/1654
9,506,262	B2 *	11/2016	Tavor	.....	E04H 4/1654

9,527,537	B2 *	12/2016	Bernini	.....	E04H 4/1654
9,790,700	B2 *	10/2017	Tamar	.....	H02K 7/1823
9,809,989	B2 *	11/2017	Blanc Tailleur	.....	E04H 4/1654
D808,095	S *	1/2018	Sebor	.....	D32/21
9,902,477	B1 *	2/2018	Durvasula	.....	B63C 11/42
10,053,883	B2 *	8/2018	Hui	.....	E04H 4/1654
10,145,137	B2 *	12/2018	Sebor	.....	E04H 4/1654
10,167,650	B2 *	1/2019	Torem	.....	E04H 4/1654

\* cited by examiner

*Primary Examiner* — Michelle E. Wilson

(74) *Attorney, Agent, or Firm* — Isus Intellectual Property PLL; Anthony Jason Mirabito

(57) **CLAIM**

The ornamental design for a pool cleaner with rear thrusters, as shown and described.

**DESCRIPTION**

FIG. 1 is a front view of the first embodiment;  
 FIG. 2 is a rear view of the first embodiment;  
 FIG. 3 is a top view of the first embodiment;  
 FIG. 4 is a right side view of the first embodiment;  
 FIG. 5 is a left side view of the first embodiment;  
 FIG. 6 is a front perspective view of the first embodiment;  
 FIG. 7 is a rear perspective view of the first embodiment;  
 FIG. 8 is a bottom view of the first embodiment;  
 FIG. 9 is a front view of the second embodiment;  
 FIG. 10 is a rear view of the second embodiment;  
 FIG. 11 is a top view of the second embodiment;  
 FIG. 12 is a right side view of the second embodiment;  
 FIG. 13 is a left side view of the second embodiment;  
 FIG. 14 is a front perspective view of the second embodiment;  
 FIG. 15 is a rear perspective view of the second embodiment; and,  
 FIG. 16 is a bottom view of the second embodiment.  
 The broken lines in the drawings are for illustrative purposes only and form no part of the claimed design.

**1 Claim, 16 Drawing Sheets**

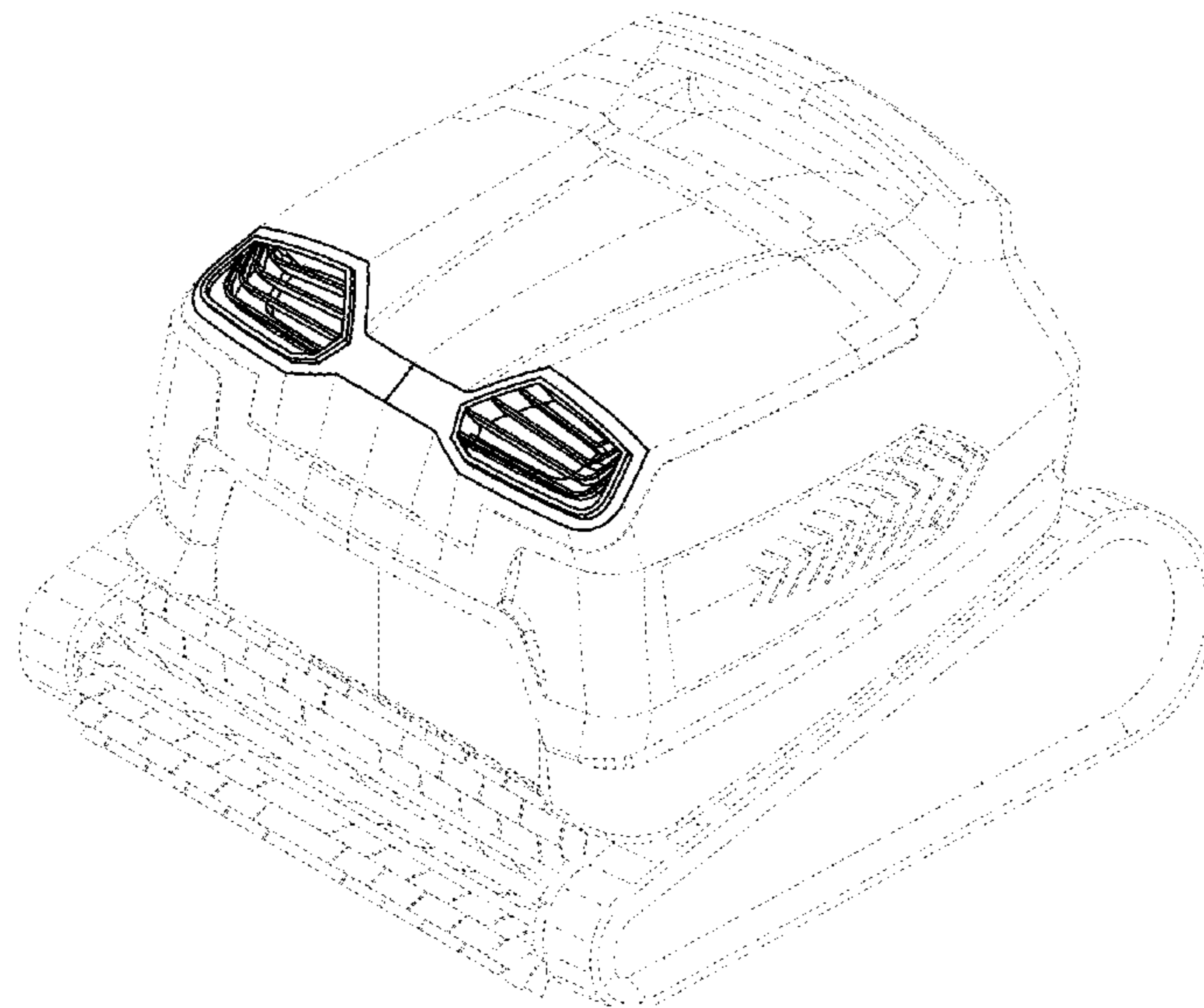

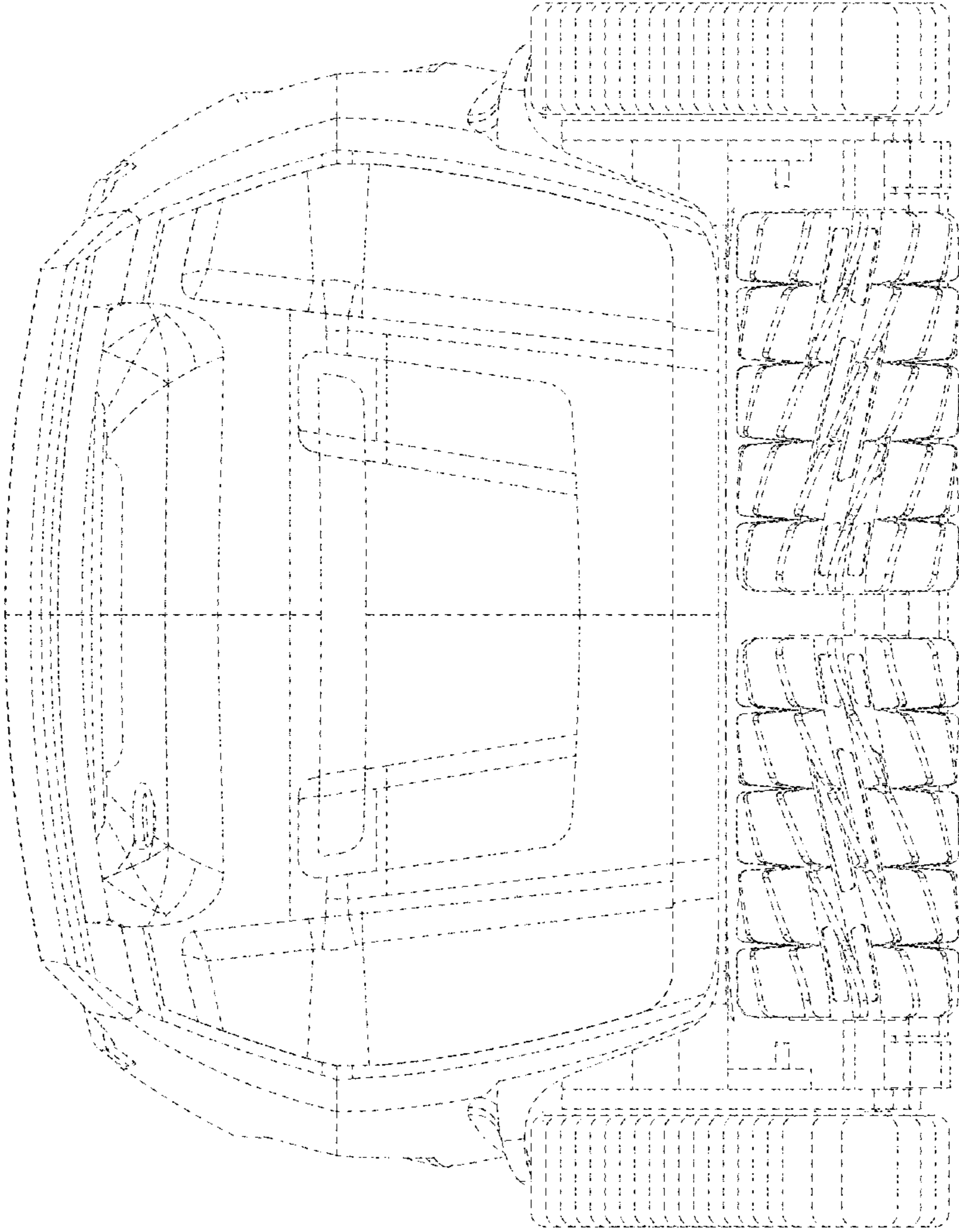

Fig. 1

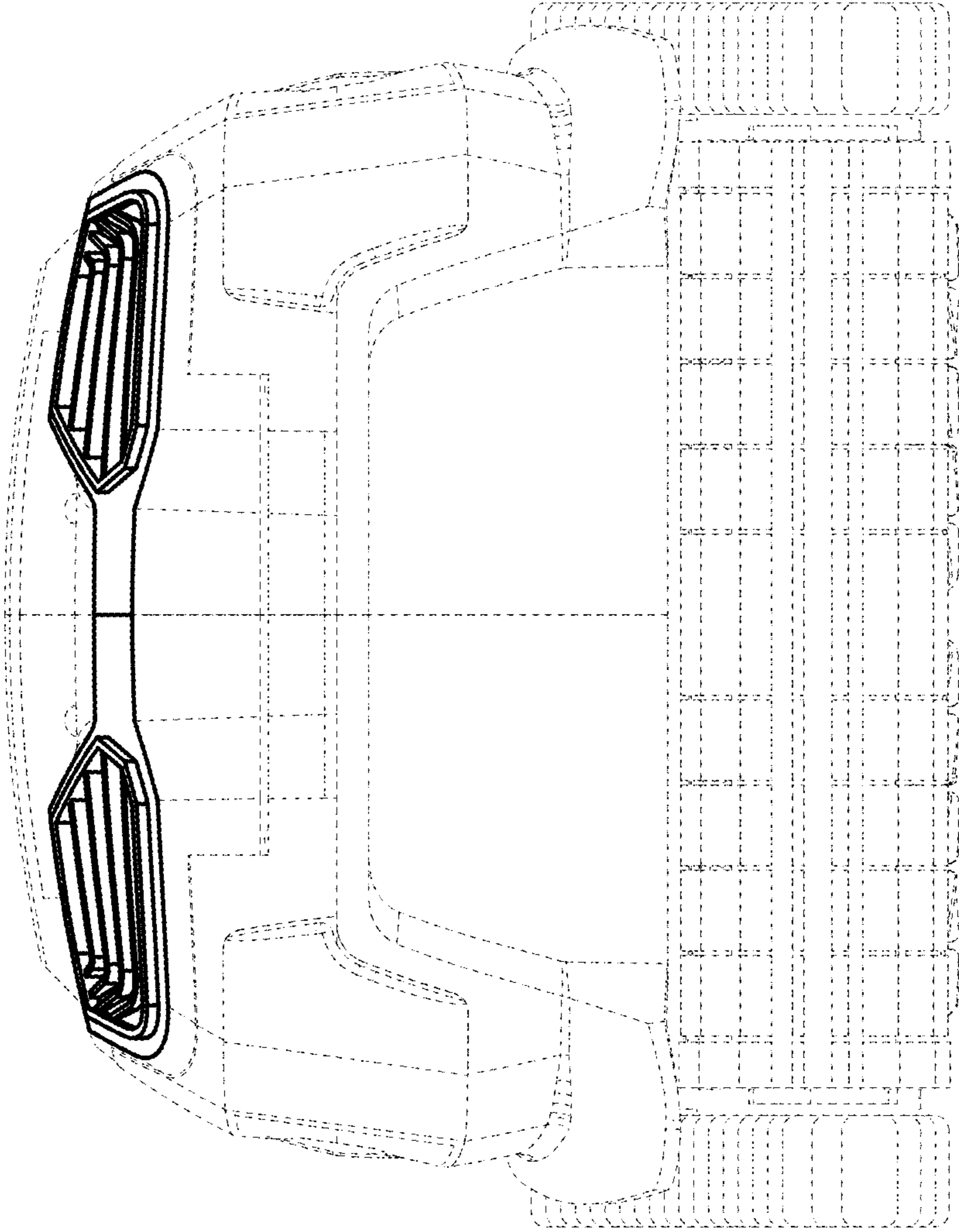

Fig. 2

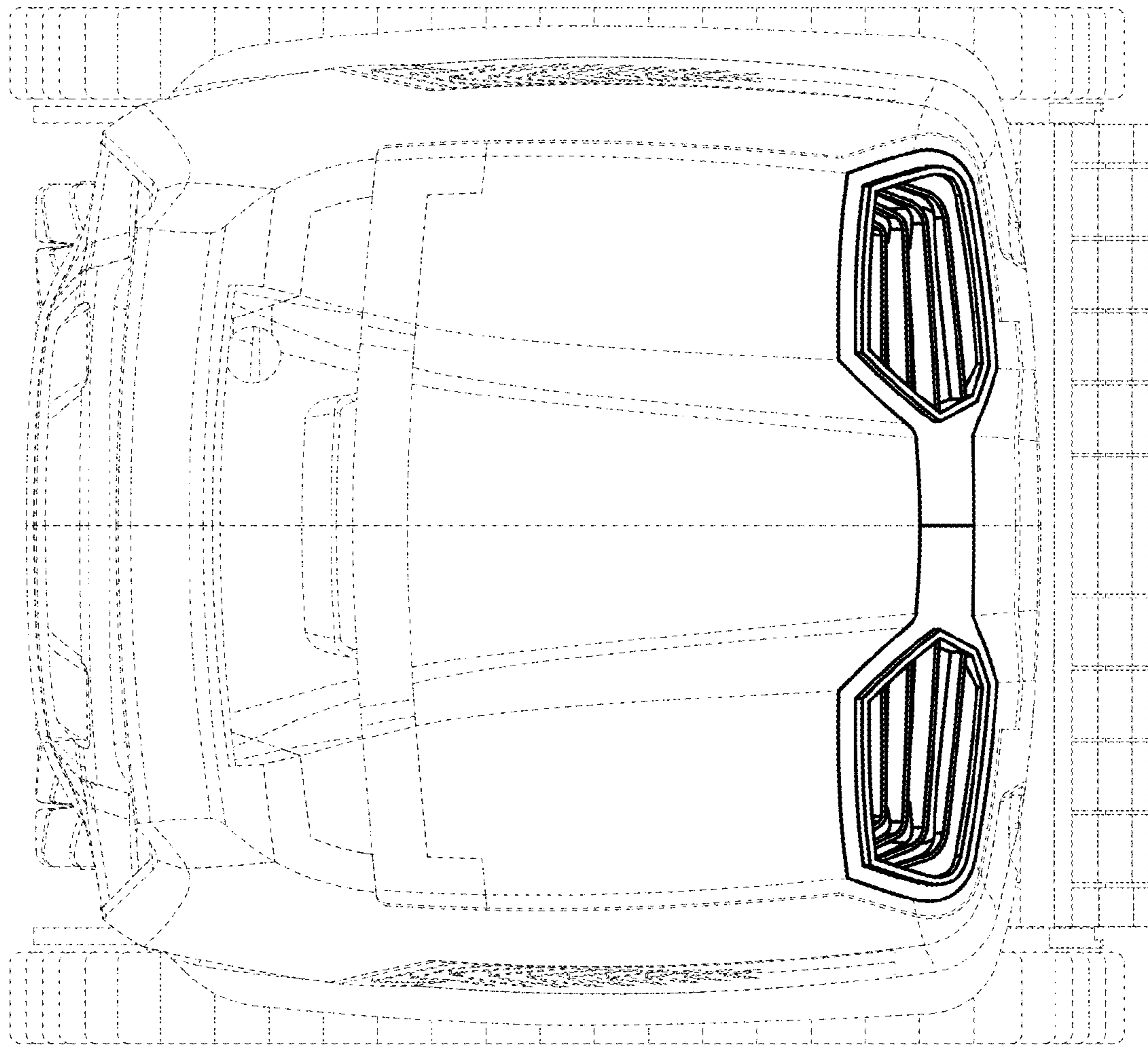

Fig. 3

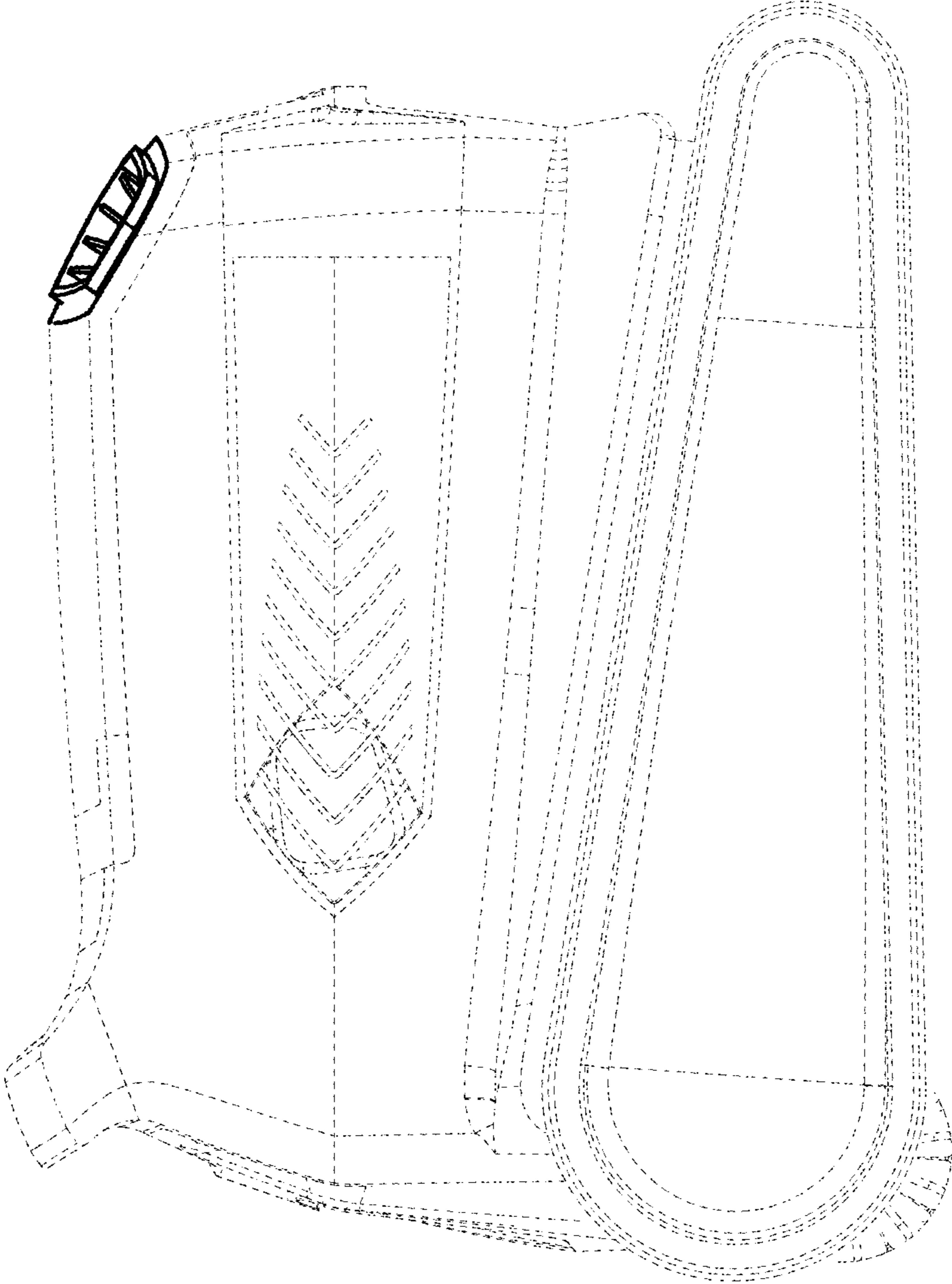

Fig. 4

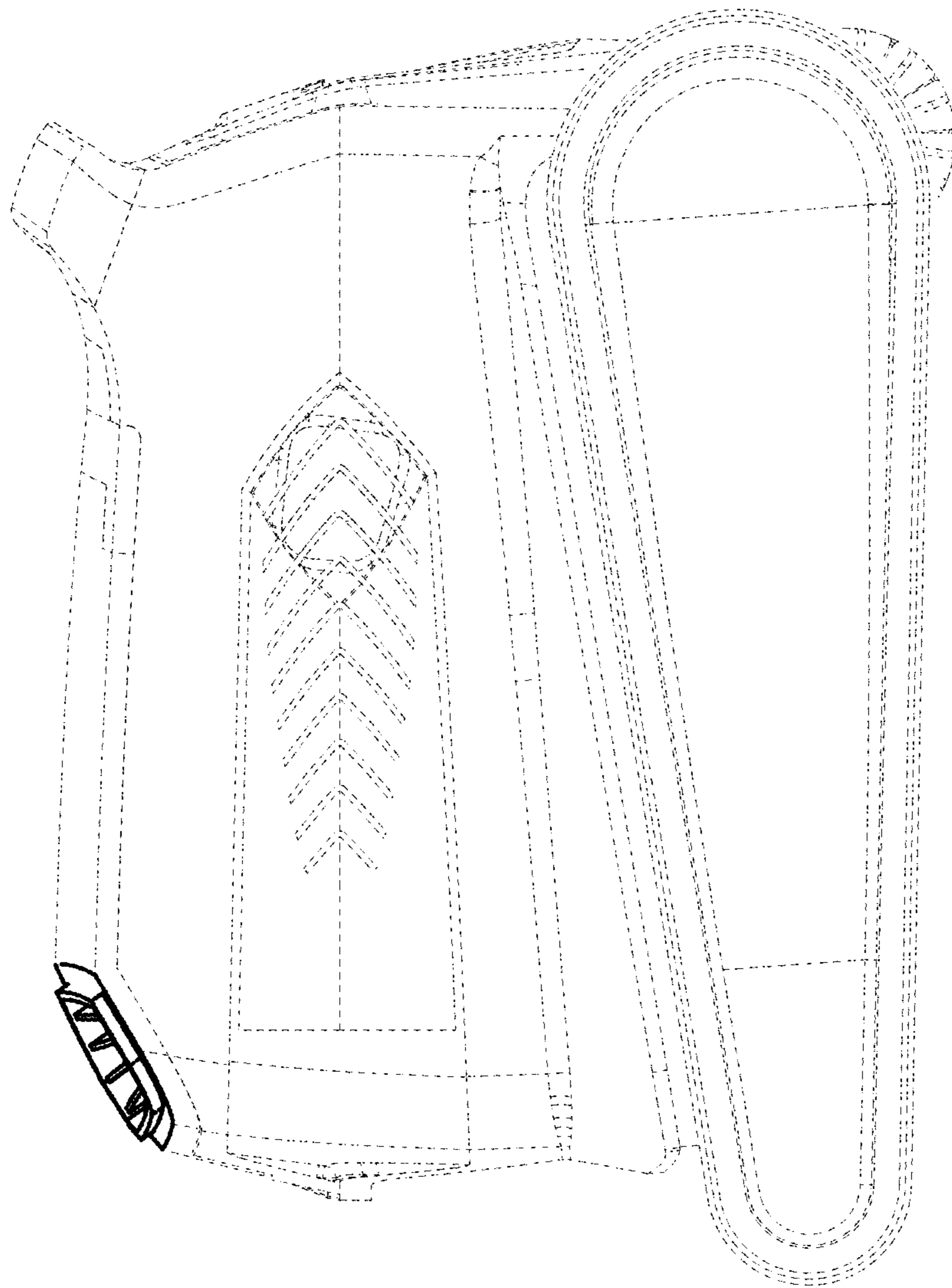

Fig. 5

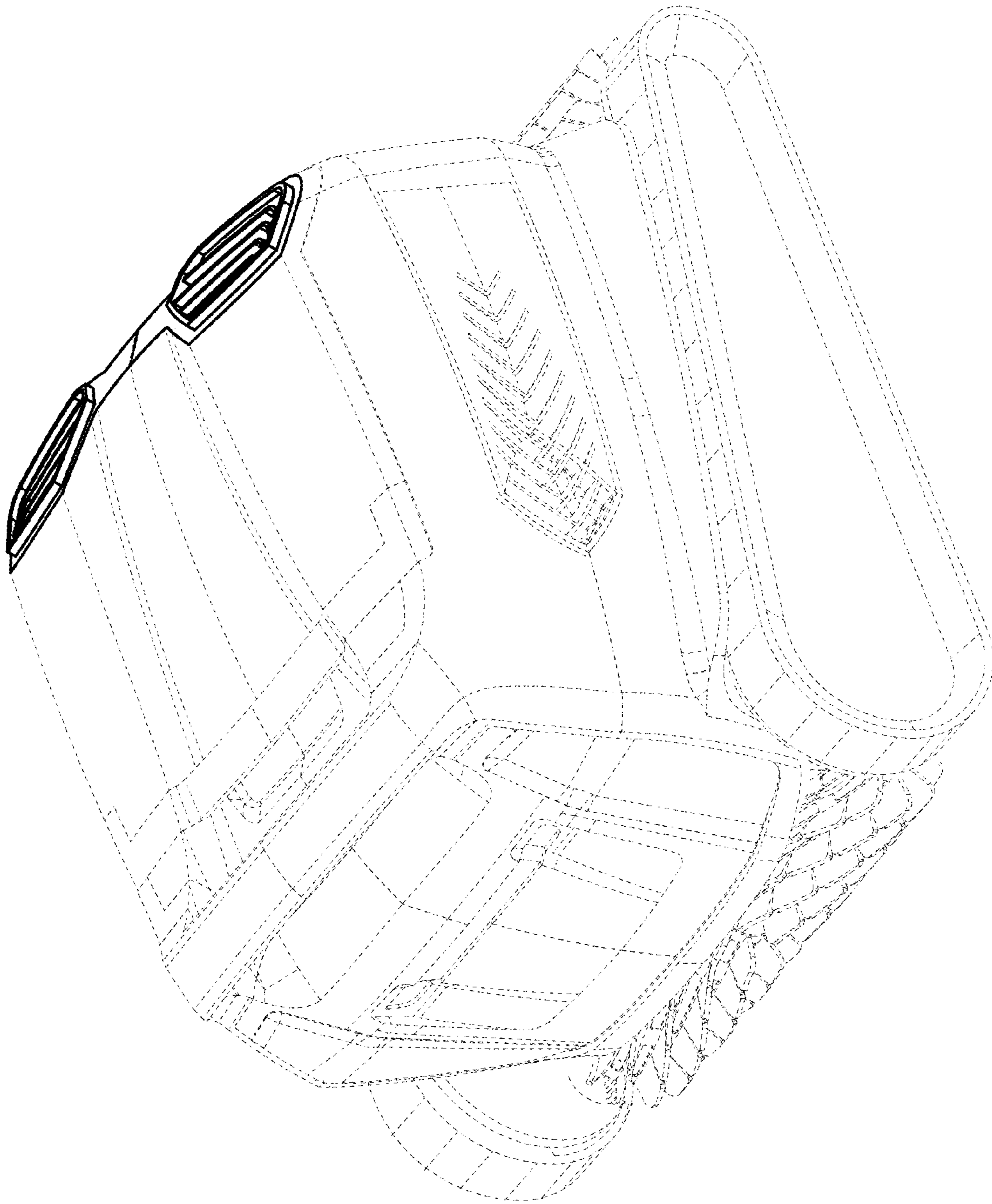

Fig. 6

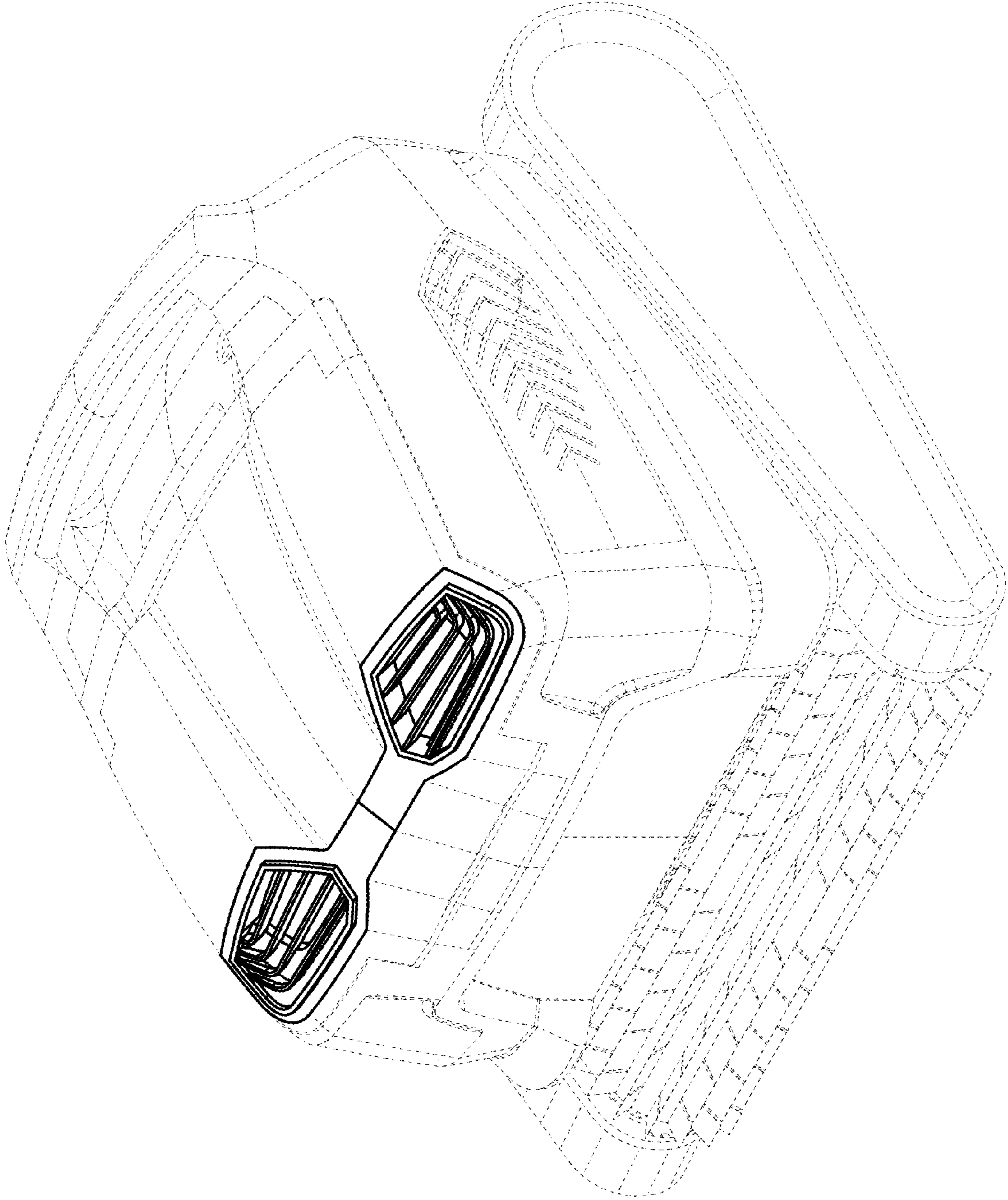

Fig. 7



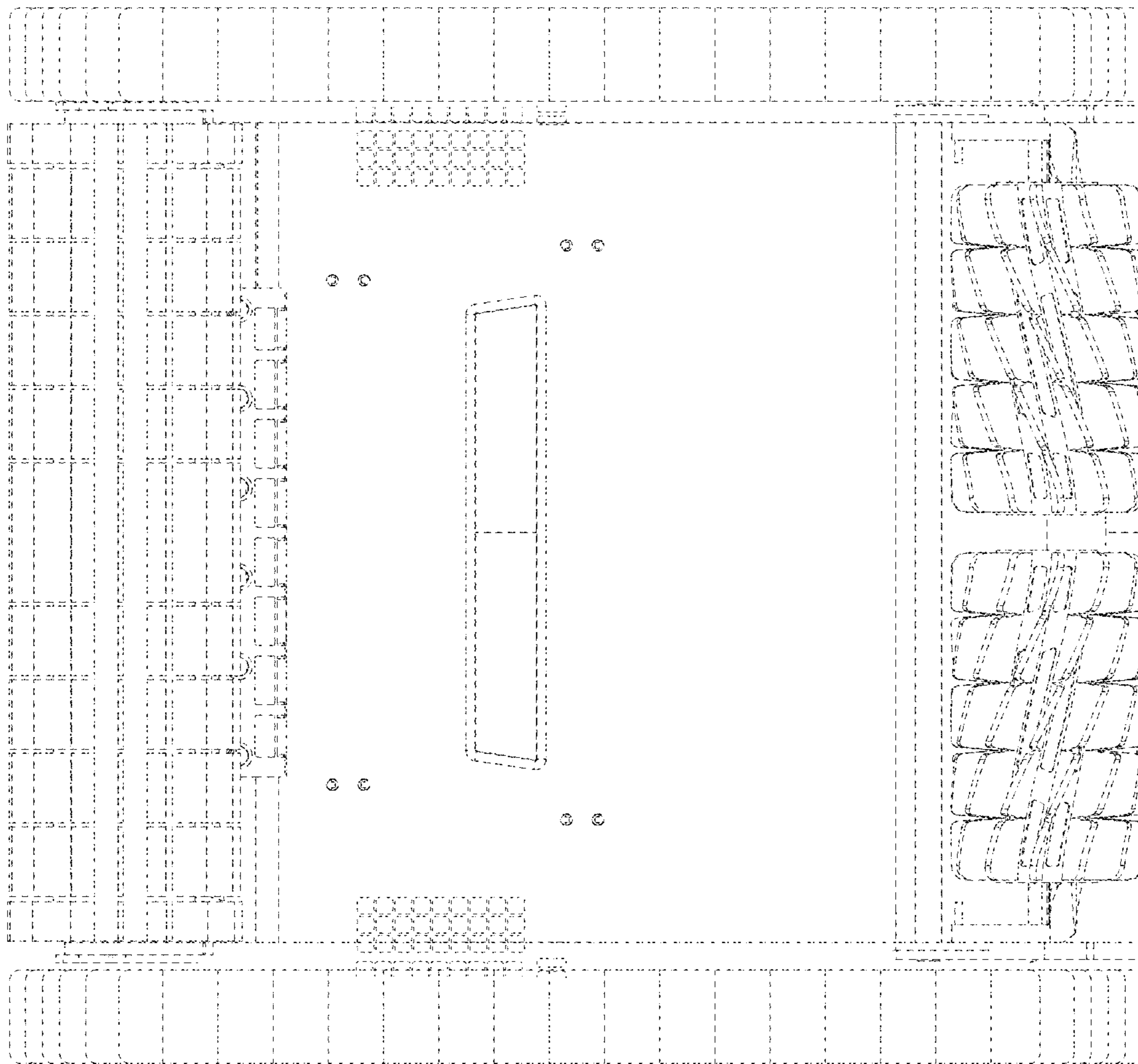

Fig. 8

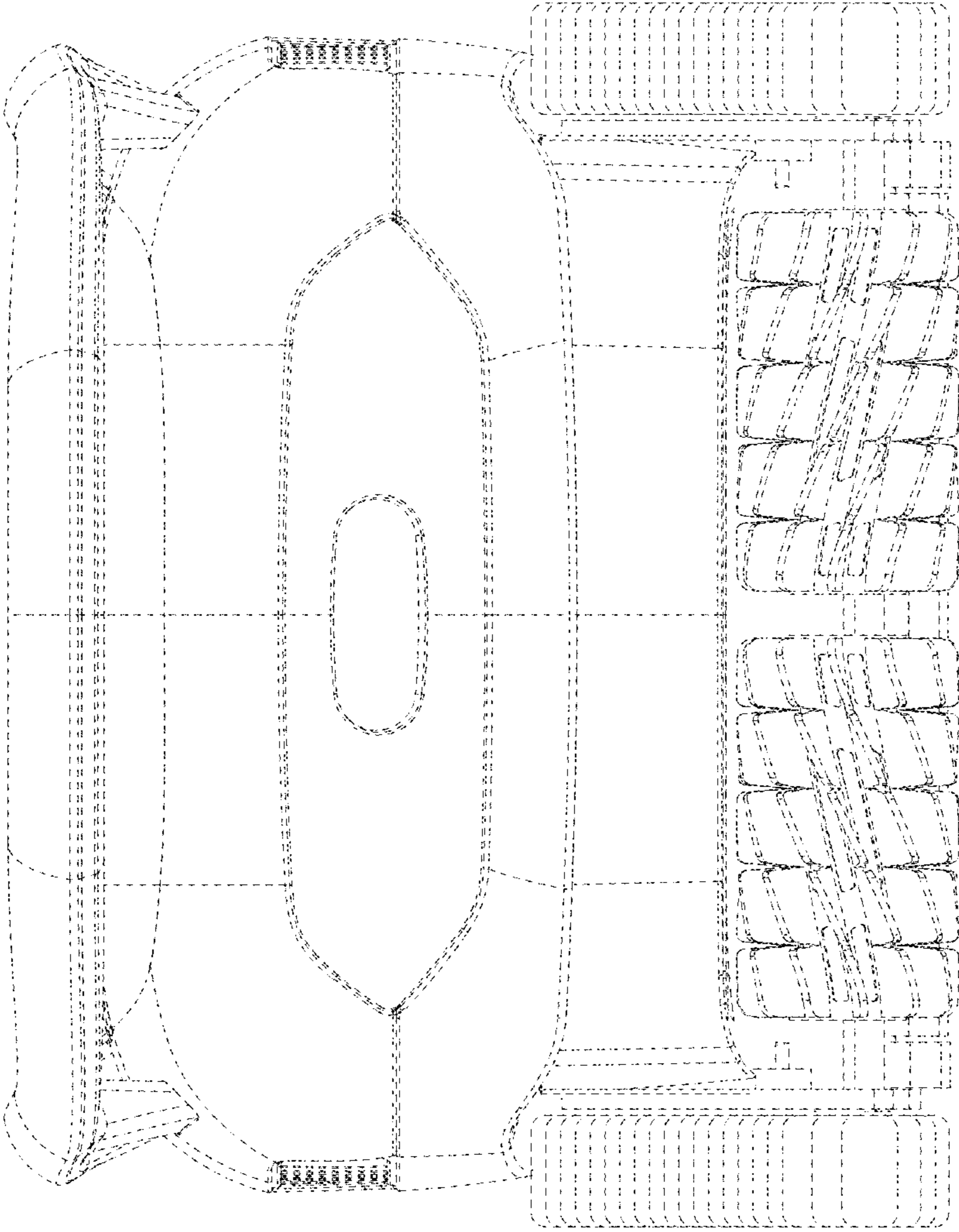

Fig. 9

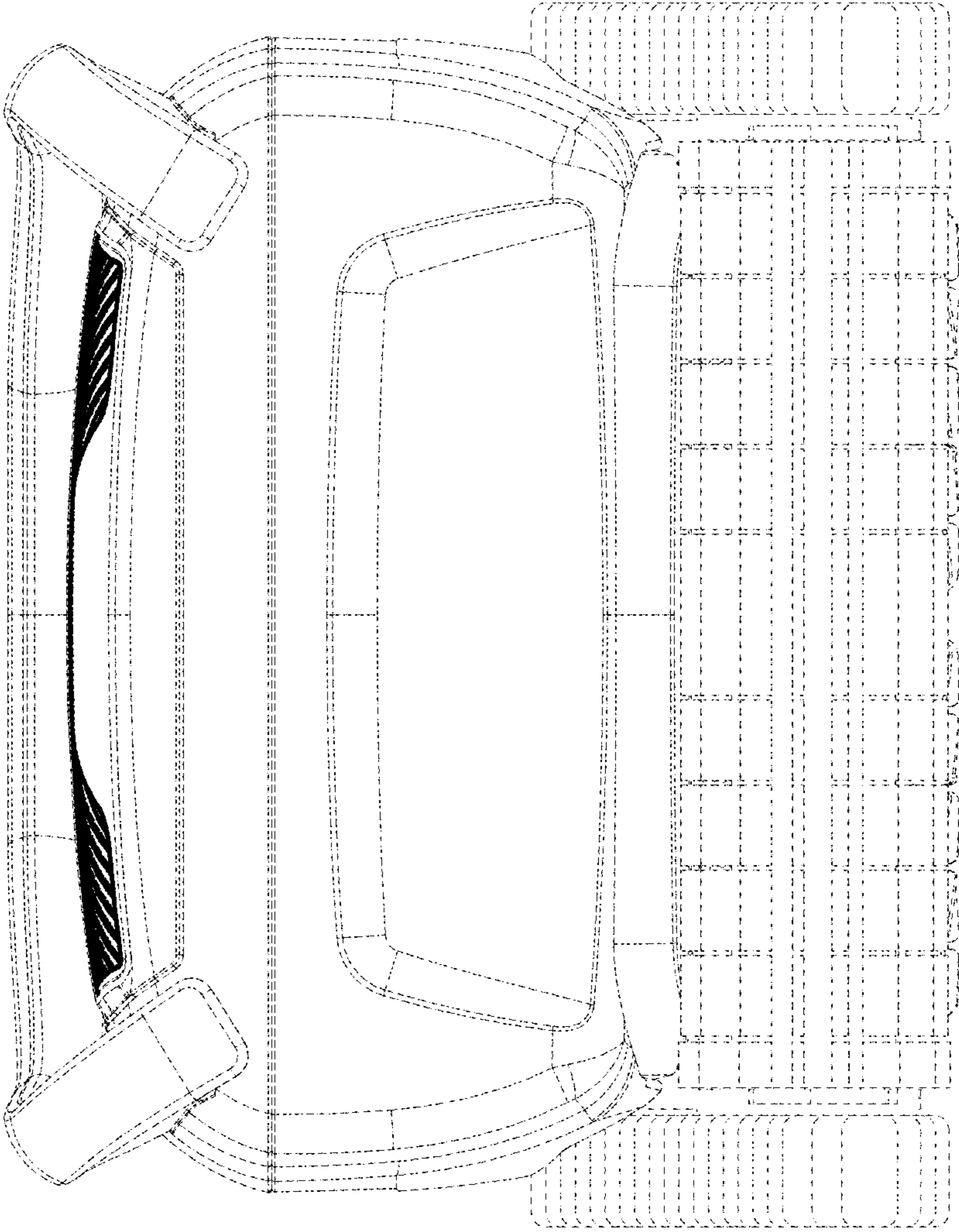

Fig. 10

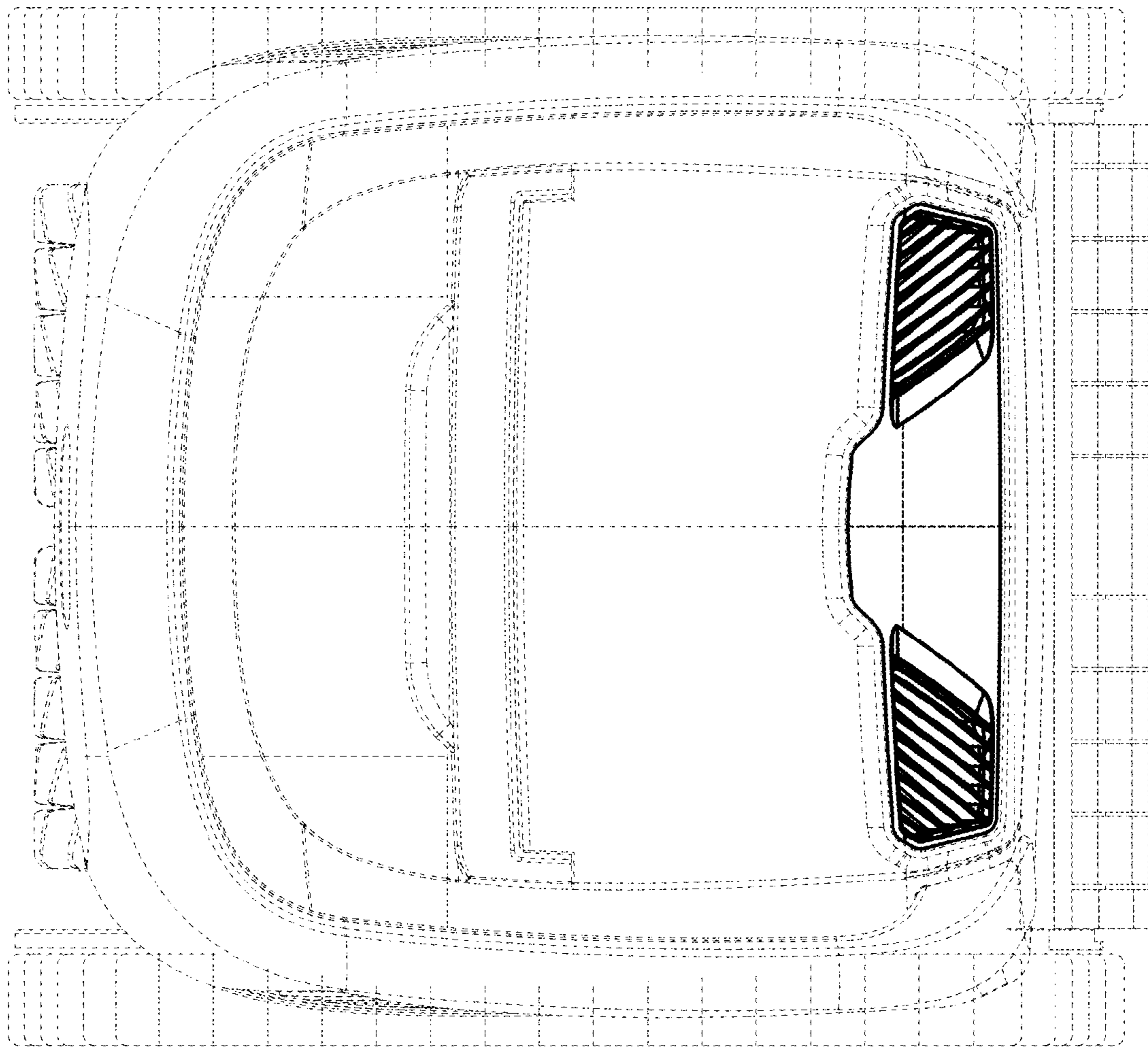

Fig. 11

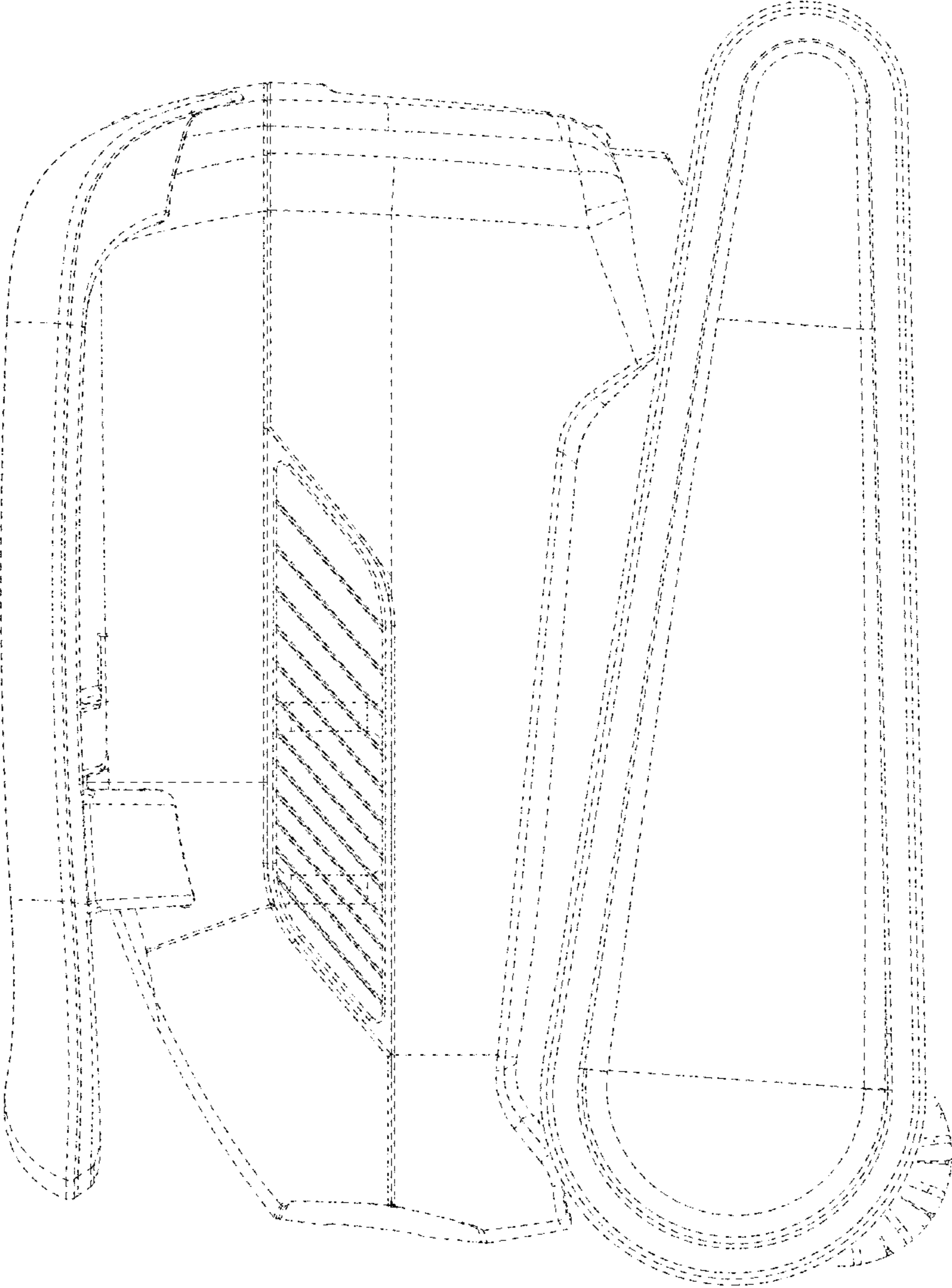

Fig. 12

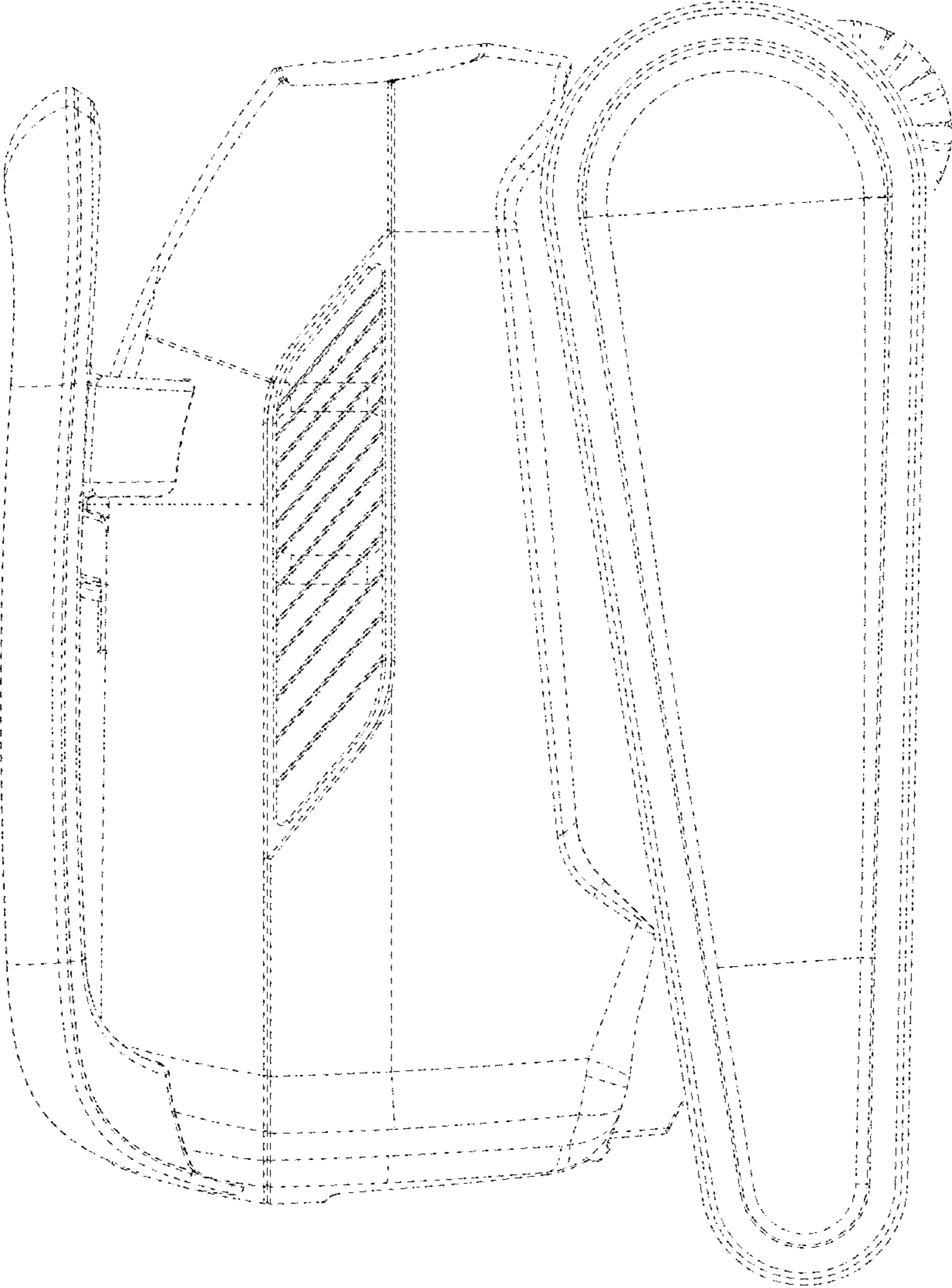

Fig. 13

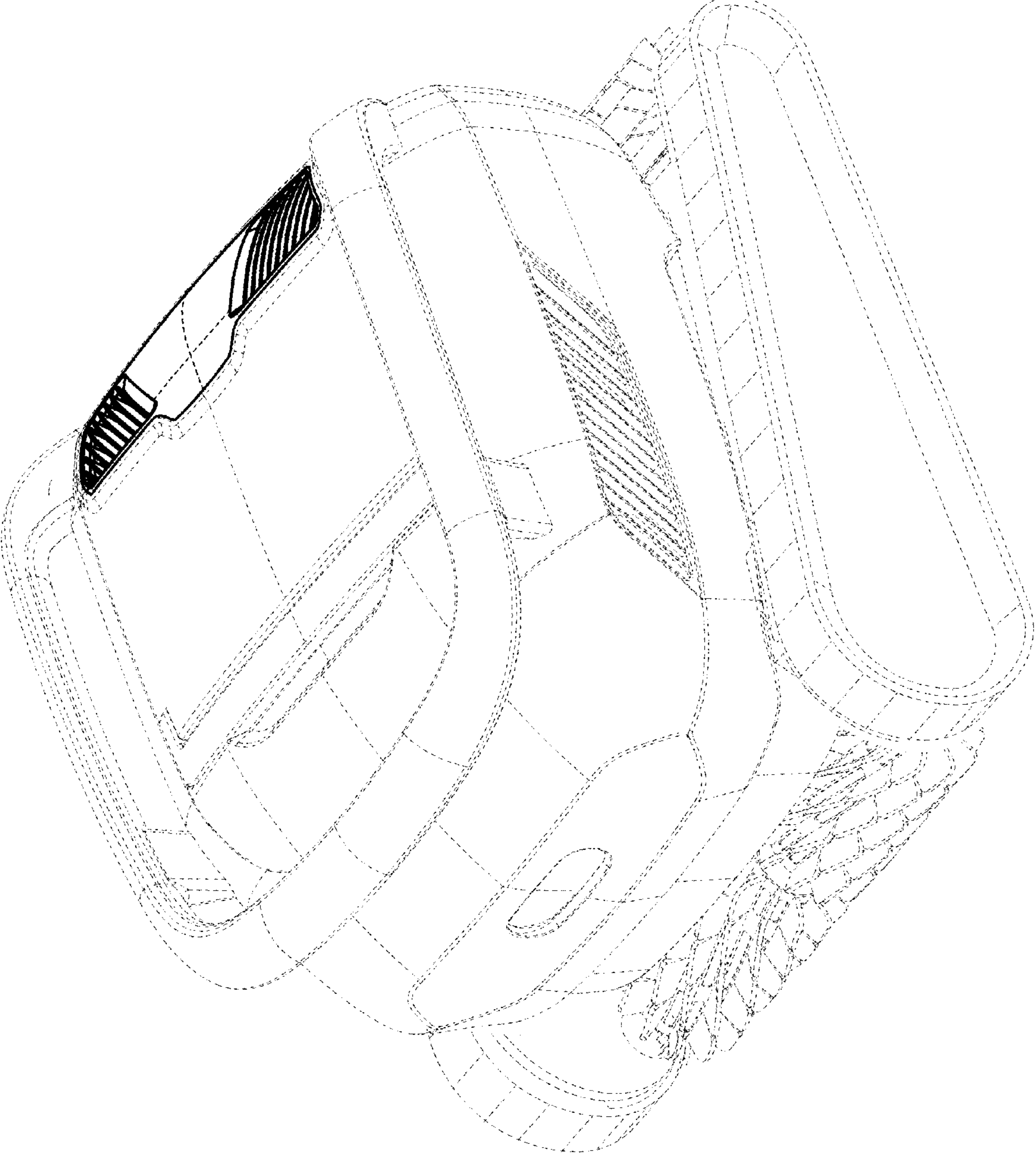

Fig. 14

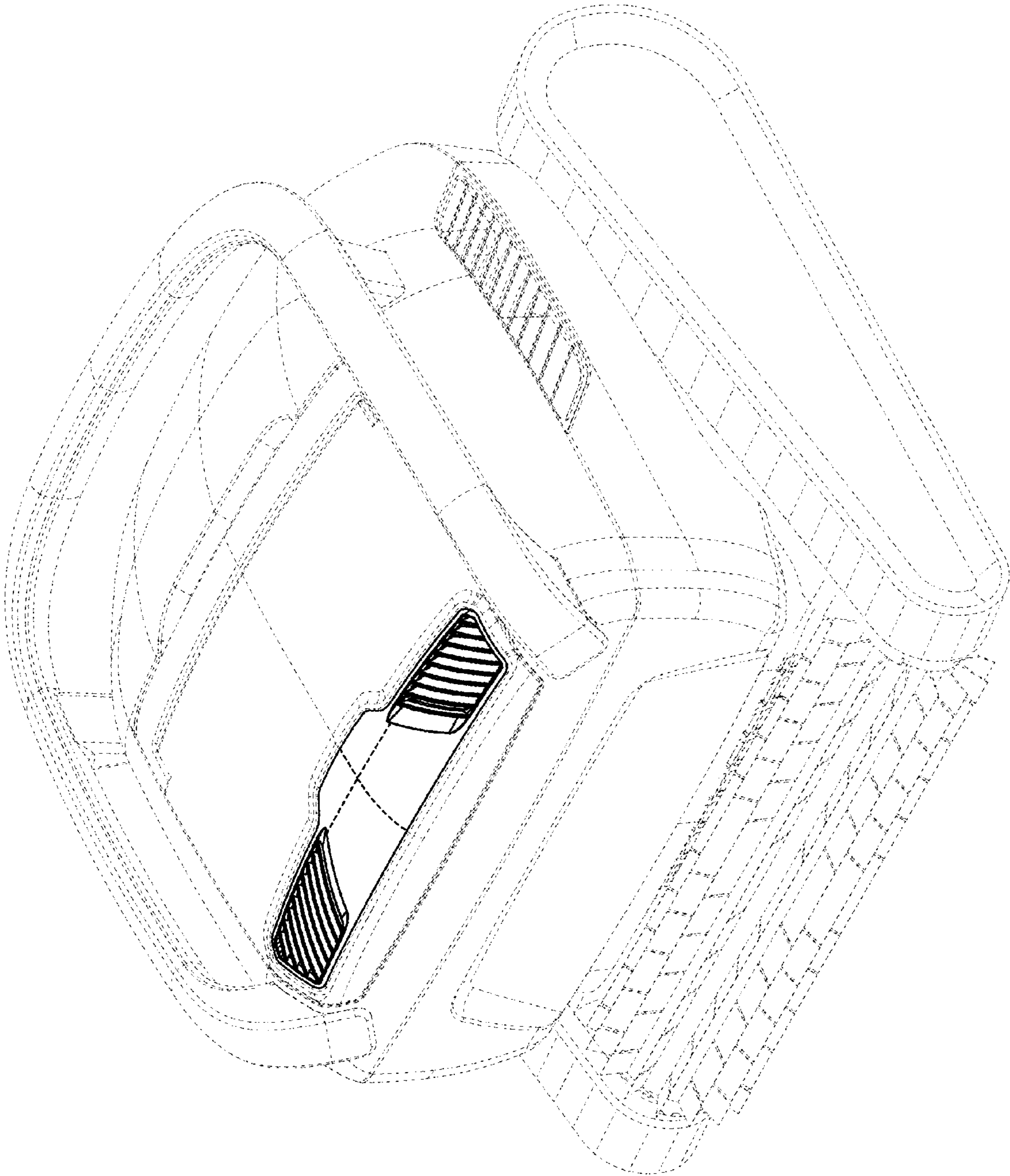

Fig. 15



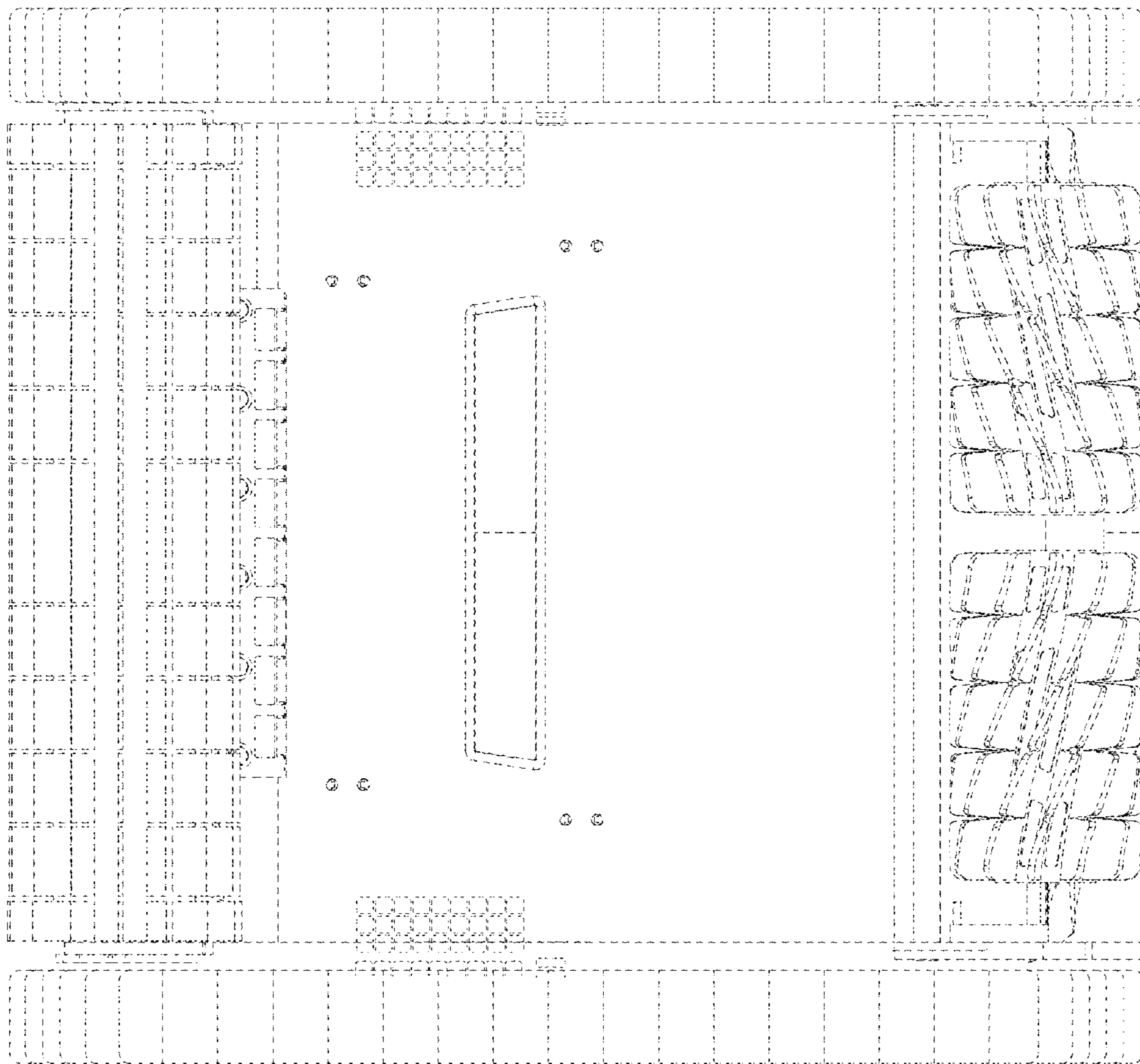

Fig. 16