



US00D874676S

(12) **United States Design Patent** (10) **Patent No.:** **US D874,676 S**
Song (45) **Date of Patent:** **** Feb. 4, 2020**

(54) **HANDHELD MASSAGER**
(71) Applicant: **HONEY WELLS INC**, Arcadia, CA (US)
(72) Inventor: **Xiaoju Song**, Shenzhen (CN)
(73) Assignee: **HONEY WELLS INC**, Arcadia, CA (US)

D465,852 S * 11/2002 Bloch D24/211
D510,628 S * 10/2005 Talbot D24/214
D538,430 S * 3/2007 Ohta D24/146
D539,432 S * 3/2007 Nan D24/215
D558,887 S * 1/2008 Nan D24/105
D585,560 S * 1/2009 Wu D24/215
D600,357 S * 9/2009 Chaput D24/214
D601,252 S * 9/2009 Ra D24/133
D636,888 S * 4/2011 Nikitezuk D24/215
(Continued)

(**) Term: **15 Years**

OTHER PUBLICATIONS

(21) Appl. No.: **29/707,307**
(22) Filed: **Sep. 27, 2019**
(51) **LOC (12) Cl.** **28-03**
(52) **U.S. Cl.**
USPC **D24/215**
(58) **Field of Classification Search**
USPC 601/15, 18, 19, 46, 47, 48, 52, 99, 112,
601/113, 118, 125, 129, 134, 135, 137,
601/DIG. 12, DIG. 14, DIG. 15, DIG. 16,
601/DIG. 17; D24/133, 200, 211, 212,
D24/213, 214, 215; 600/38, 39, 40, 41
CPC A61H 1/00; A61H 7/001; A61H 7/002;
A61H 7/007
See application file for complete search history.

“Cordless Wand Massager, Wireless Handheld Magic Electric Massage Wands with 12 Frequency Modes Therapeutic Massaging Device Mini Rechargeable Waterproof Portable for Full Body Massager”, Retrieved Sep. 27, 2019]. Retrieved from Internet, <https://www.amazon.co.uk/Frequency-Therapeutic-Massaging-Rechargeable-Waterproof/dp/B07S49MLXS/>.
(Continued)

Primary Examiner — Cynthia Ramirez
Assistant Examiner — Michael A Maharajh

(57) **CLAIM**

The ornamental design for a handheld massager, as shown and described.

DESCRIPTION

FIG. 1 is a perspective view of a handheld massager showing my new design;
FIG. 2 is another perspective view thereof;
FIG. 3 is a front elevational view thereof;
FIG. 4 is a rear elevational view thereof;
FIG. 5 is a left side elevational view thereof;
FIG. 6 is a right side elevational view thereof;
FIG. 7 is a top plan view thereof; and,
FIG. 8 is a bottom plan view thereof.
The broken lines in the drawings depict portions of the handheld massager that form no part of the claimed design.

(56) **References Cited**

U.S. PATENT DOCUMENTS

D266,532 S * 10/1982 Grube D24/211
D272,649 S * 2/1984 Bloch D21/662
D301,617 S * 6/1989 Yonesawa D24/211
D311,955 S * 11/1990 Lie D24/211
D315,408 S * 3/1991 Duk D24/211
D320,453 S * 10/1991 Von Winckler D24/200
D338,070 S * 8/1993 Lam D24/214
D351,660 S * 10/1994 Ichikawa D24/200
D374,084 S * 9/1996 Chen D24/211
D384,158 S * 9/1997 Kain D24/200
D385,965 S * 11/1997 Wallesen D24/212
D446,584 S * 8/2001 Chen D21/662

1 Claim, 8 Drawing Sheets

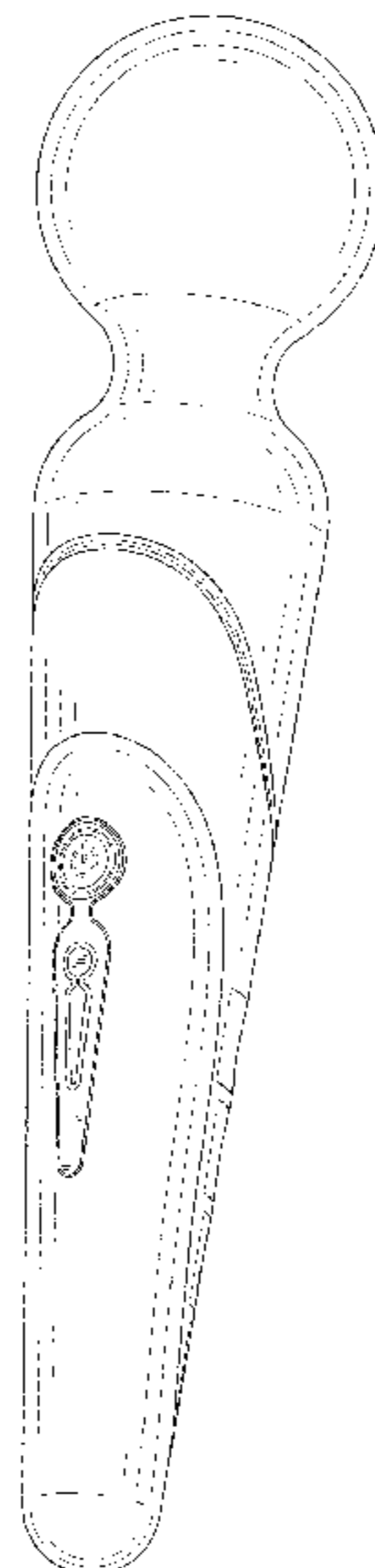

(56)

References Cited

U.S. PATENT DOCUMENTS

D648,034 S * 11/2011 Rice D24/215
 D649,656 S * 11/2011 Petersen D24/215
 D663,836 S * 7/2012 Ruiz, Sr. D24/133
 D667,132 S * 9/2012 Marshall D24/215
 D668,346 S * 10/2012 Zeng D24/215
 D673,687 S * 1/2013 Zeng D24/215
 D674,109 S * 1/2013 Sedic D24/215
 D676,140 S * 2/2013 Feightner D24/212
 D681,842 S * 5/2013 Chang D24/215
 8,496,572 B2 * 7/2013 Lee A61H 19/44
 600/38
 D693,933 S * 11/2013 Tai D24/215
 D694,416 S * 11/2013 Tai D24/215
 D694,417 S * 11/2013 Tai D24/215
 D698,452 S * 1/2014 Tai D24/215
 D704,345 S * 5/2014 Tai D24/215
 D723,711 S * 3/2015 Elliott D24/215
 D740,433 S * 10/2015 Zhu A61H 15/0085
 D24/215
 D760,914 S * 7/2016 Hutchinson D24/215
 D768,308 S * 10/2016 Hetzel D24/214
 D801,544 S * 10/2017 Zinn D24/215
 D802,784 S * 11/2017 Lee D24/215
 D817,507 S * 5/2018 Cheung D24/215
 D818,143 S * 5/2018 Cheung D24/215
 D823,477 S * 7/2018 Yang D24/215
 D826,418 S * 8/2018 Lad D24/215
 D827,850 S * 9/2018 Pounders D24/215
 D842,492 S * 3/2019 Iurchenko D24/215
 D843,592 S * 3/2019 Tsuyama D24/215
 D844,801 S * 4/2019 Cheung D24/215
 D853,572 S * 7/2019 Yi D24/200

D865,989 S * 11/2019 Colclough D24/215
 2008/0194907 A1 * 8/2008 Lin A61H 19/44
 600/38
 2010/0204542 A1 * 8/2010 Hodge A61F 5/41
 600/39
 2011/0040142 A1 * 2/2011 Eum A61F 5/41
 600/38
 2011/0071445 A1 * 3/2011 Imboden A61H 19/30
 601/46
 2012/0136205 A1 * 5/2012 Aguilera Galeote .. A61H 19/44
 600/38
 2012/0143001 A1 * 6/2012 Case A61F 5/455
 600/38
 2013/0158447 A1 * 6/2013 Shabazian A61H 23/0263
 601/46
 2014/0194794 A1 * 7/2014 Sedic A61H 23/02
 601/72

OTHER PUBLICATIONS

“Wireless Wand Massager by SIMILKY | Full Body Cordless Waterproof Electric Massaging for Muscles and Stress | Best Handheld Mini Magic Wand | 20 Vibration Patterns | Small Portable(Black)”, Retrieved Sep. 27, 2019]. Retrieved from Internet, <https://www.amazon.co.uk/Wireless-SIMILKY-Waterproof-Massaging-Vibration/dp/B07WMFQZ66/>.
 “Wand Massager Premium 2019—James love Therapeutic Cordless Personal Massager kit for Sore Body, Foot, Back Muscle Aches with 8 Powerful speeds. 20 Vibration Patterns Rechargeable Handheld”, Retrieved Sep. 27, 2019]. Retrieved from Internet, <https://www.amazon.co.uk/Massager-love-Therapeutic-Vibration-Rechargeable/dp/B07Q2PPP83/>.

* cited by examiner

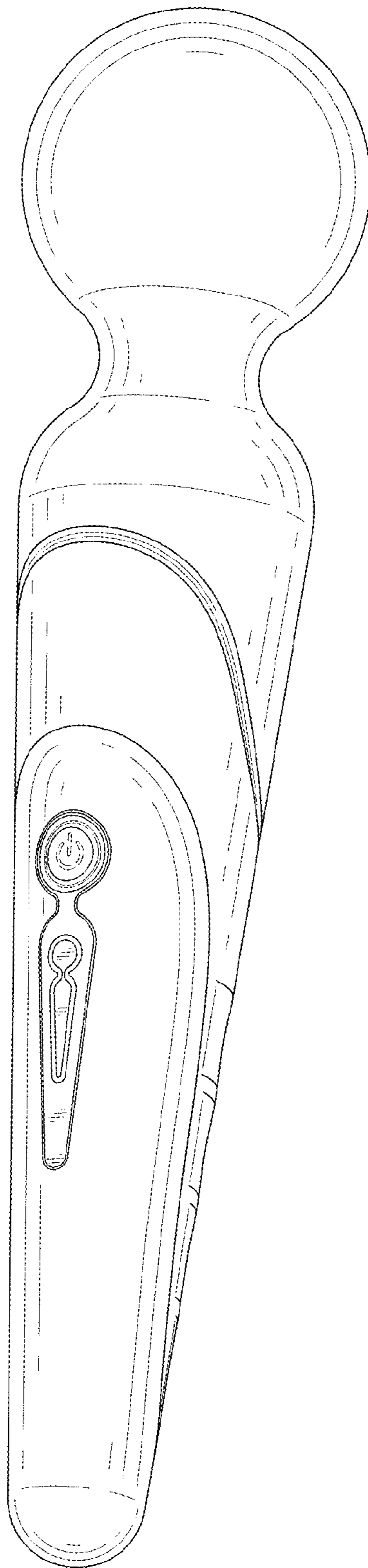

FIG. 1

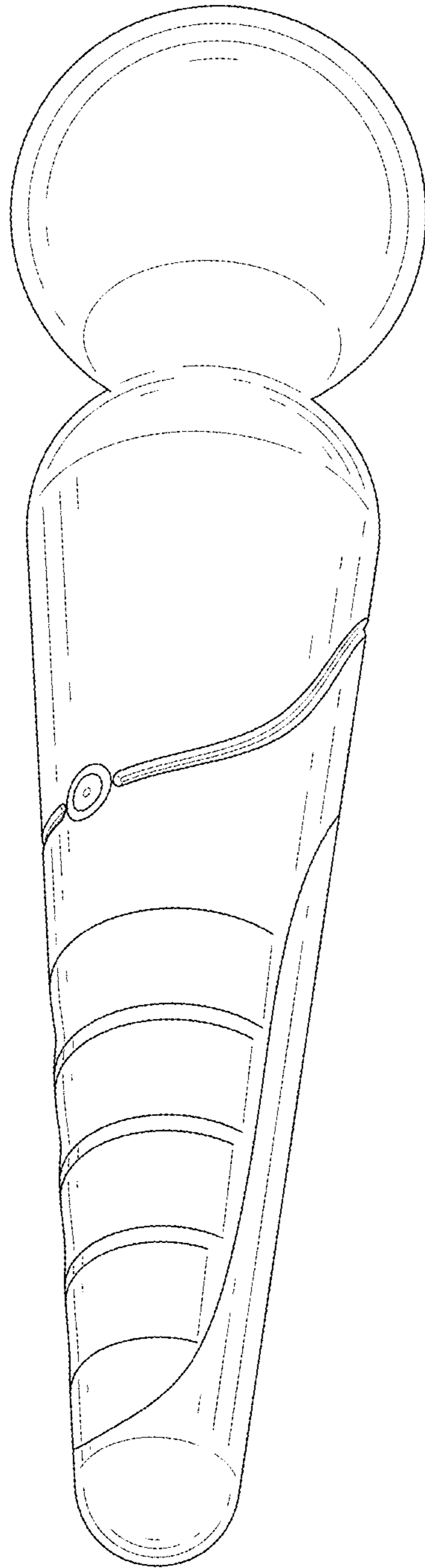

FIG. 2

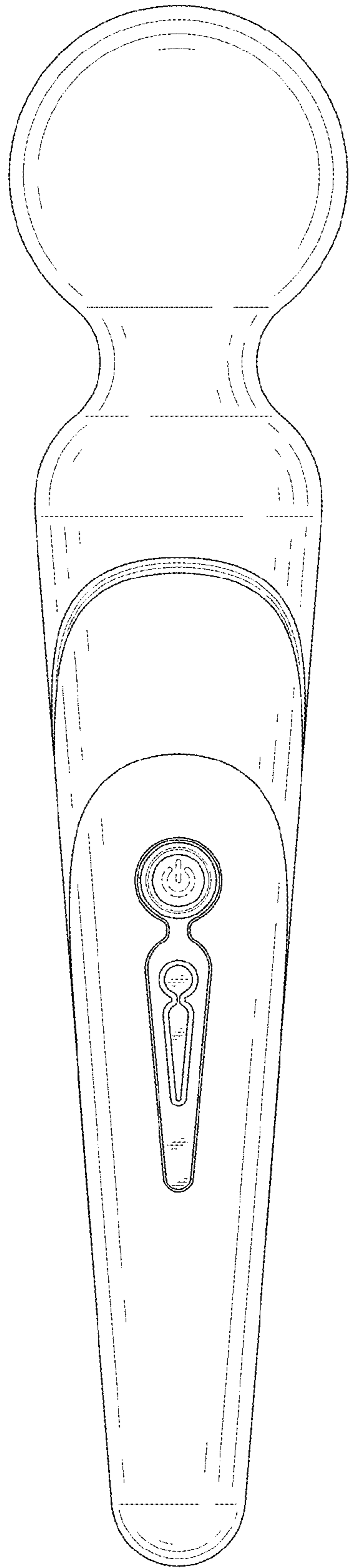

FIG. 3

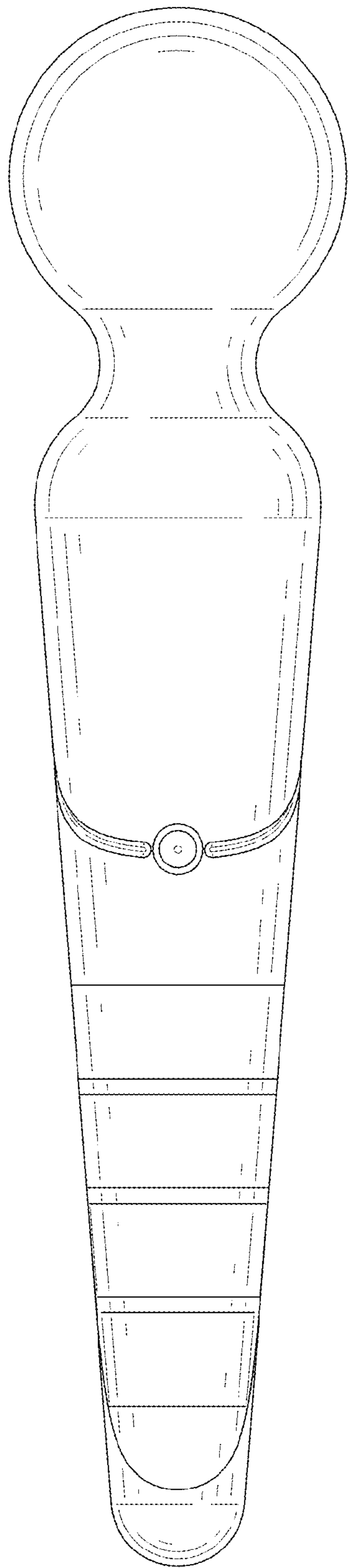

FIG. 4

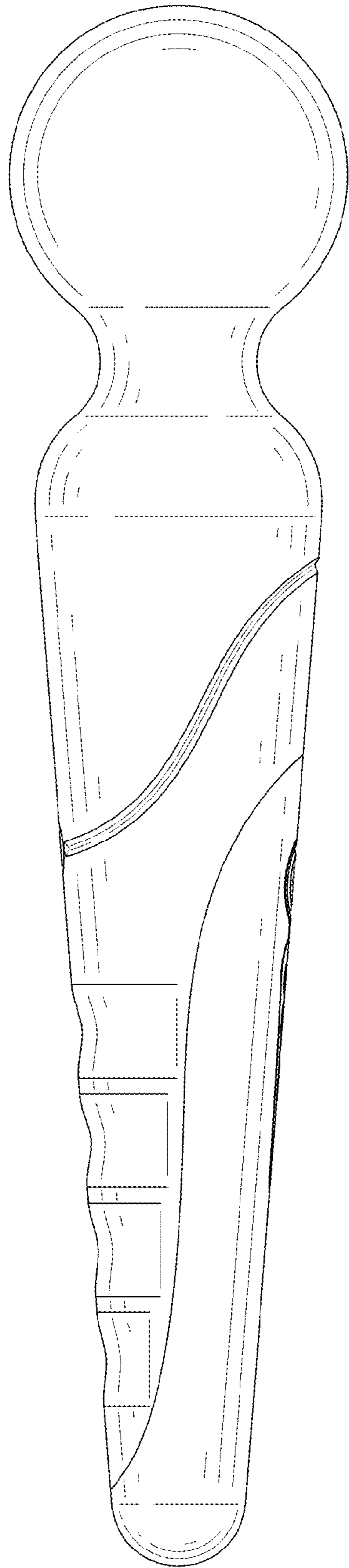

FIG. 5

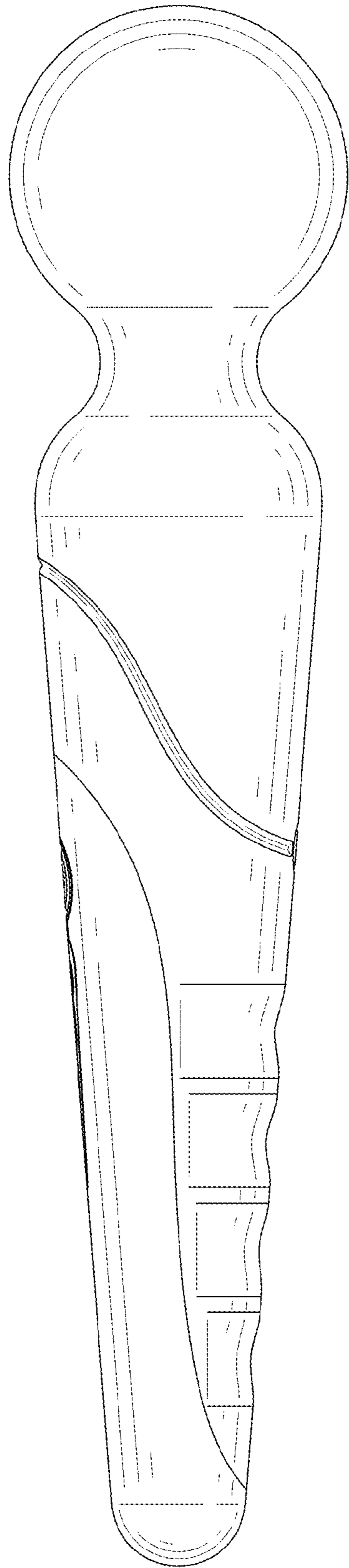

FIG. 6

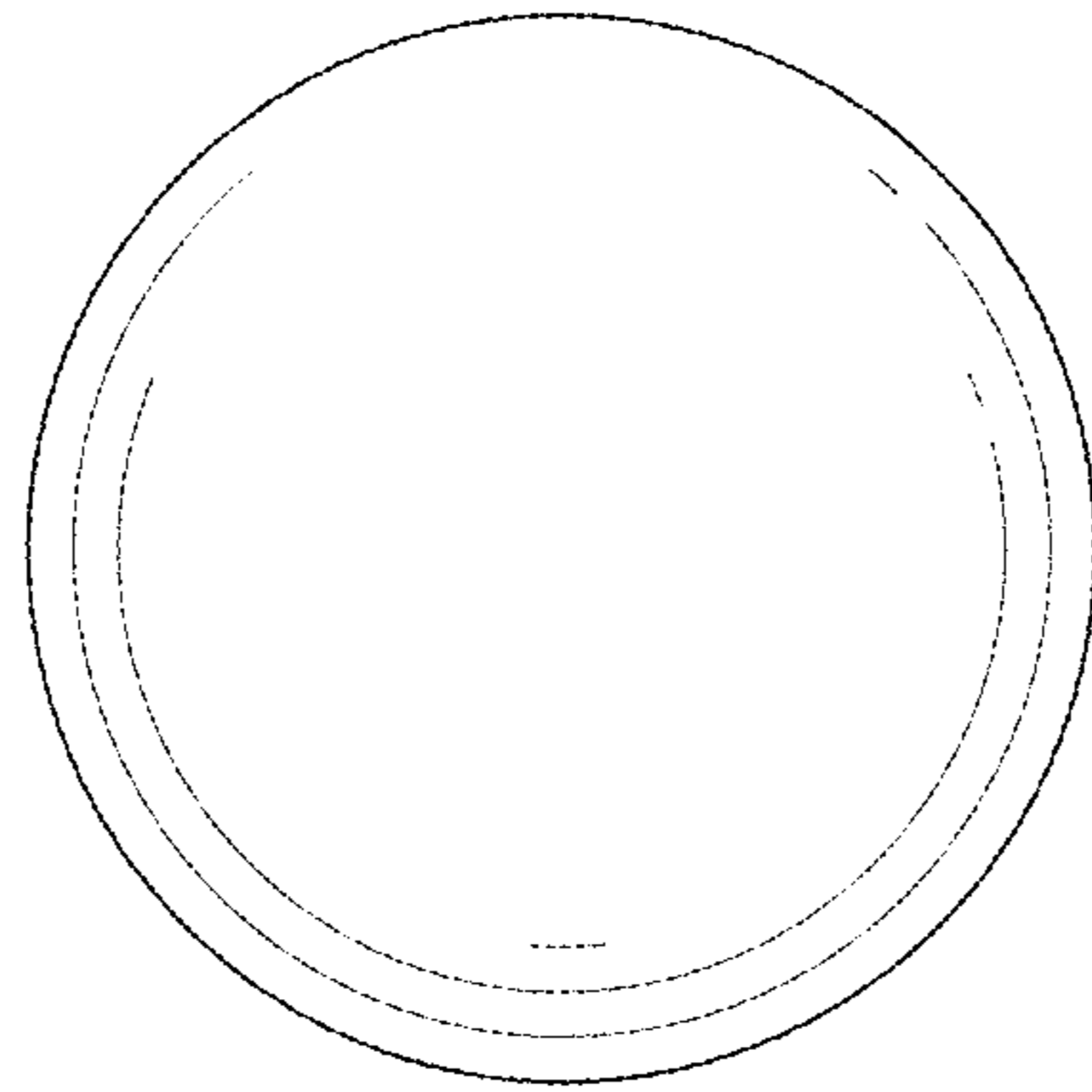

FIG. 7

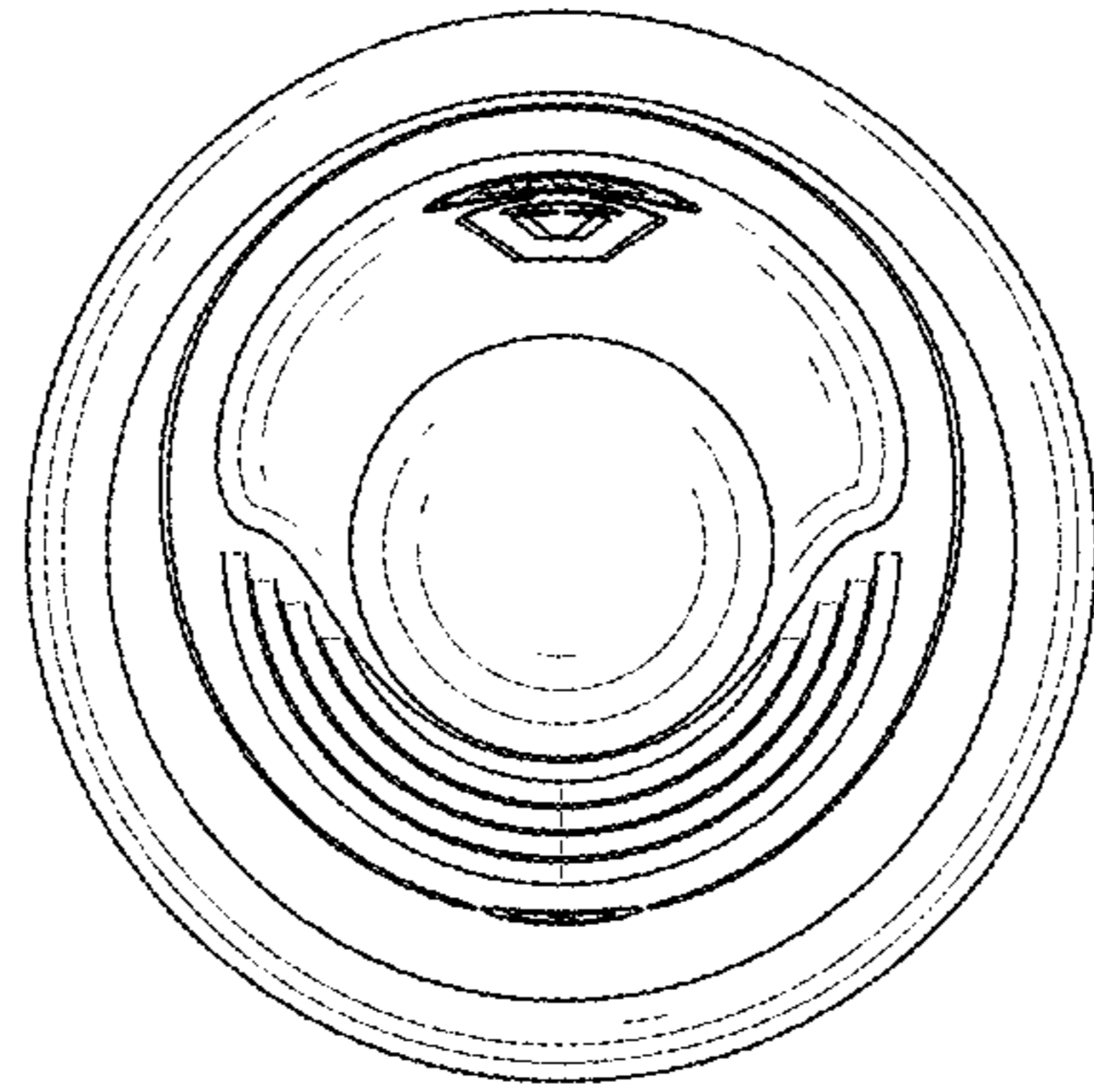

FIG. 8