



US00D874607S

(12) **United States Design Patent**
Ni

(10) **Patent No.:** **US D874,607 S**

(45) **Date of Patent:** **** Feb. 4, 2020**

(54) **STUN GUN WITH LED ILLUMINATION AND SIREN**

(71) Applicant: **Buzhong Ni**, Pinghu (CN)

(72) Inventor: **Buzhong Ni**, Pinghu (CN)

(**) Term: **15 Years**

(21) Appl. No.: **29/667,874**

(22) Filed: **Oct. 25, 2018**

(51) **LOC (12) Cl.** **22-02**

(52) **U.S. Cl.**
USPC **D22/117**

(58) **Field of Classification Search**
USPC D22/117; D26/38; 42/1.08, 1.09;
361/232; 200/519; 340/321, 574, 693.8;
222/39, 113, 192, 153.03, 123.11, 162,
222/175, 402.21; 89/1.11
CPC A62B 3/005; A62B 33/00; F41H 9/10;
F41H 13/0018; F41B 15/04; F21L 4/00;
F21L 4/02; H05B 3/03; H05B 3/44;
G08B 15/004; G08B 21/0297; G08B
21/0446
See application file for complete search history.

(56) **References Cited**

U.S. PATENT DOCUMENTS

D748,309 S * 1/2016 Cheng D22/117
D782,603 S * 3/2017 Fan D22/117

D783,117 S * 4/2017 Gilbarte D22/117
D783,118 S * 4/2017 Fan D22/117
D797,882 S * 9/2017 Tang D22/117
D798,415 S * 9/2017 Lin D22/117
D823,981 S * 7/2018 Tang D22/117
D838,336 S * 1/2019 Tang D22/117

* cited by examiner

Primary Examiner — Catherine R Oliver-Garcia

(74) *Attorney, Agent, or Firm* — W&K IP

(57) **CLAIM**

The ornamental design for a stun gun with LED illumination and siren, as shown and described.

DESCRIPTION

FIG. 1 is a perspective view showing a stun gun with LED illumination and siren;
FIG. 2 is a front view thereof;
FIG. 3 is a rear view thereof;
FIG. 4 is a left side view thereof;
FIG. 5 is a right side view thereof;
FIG. 6 is a top plan view thereof; and,
FIG. 7 is a bottom plan view thereof.

1 Claim, 7 Drawing Sheets

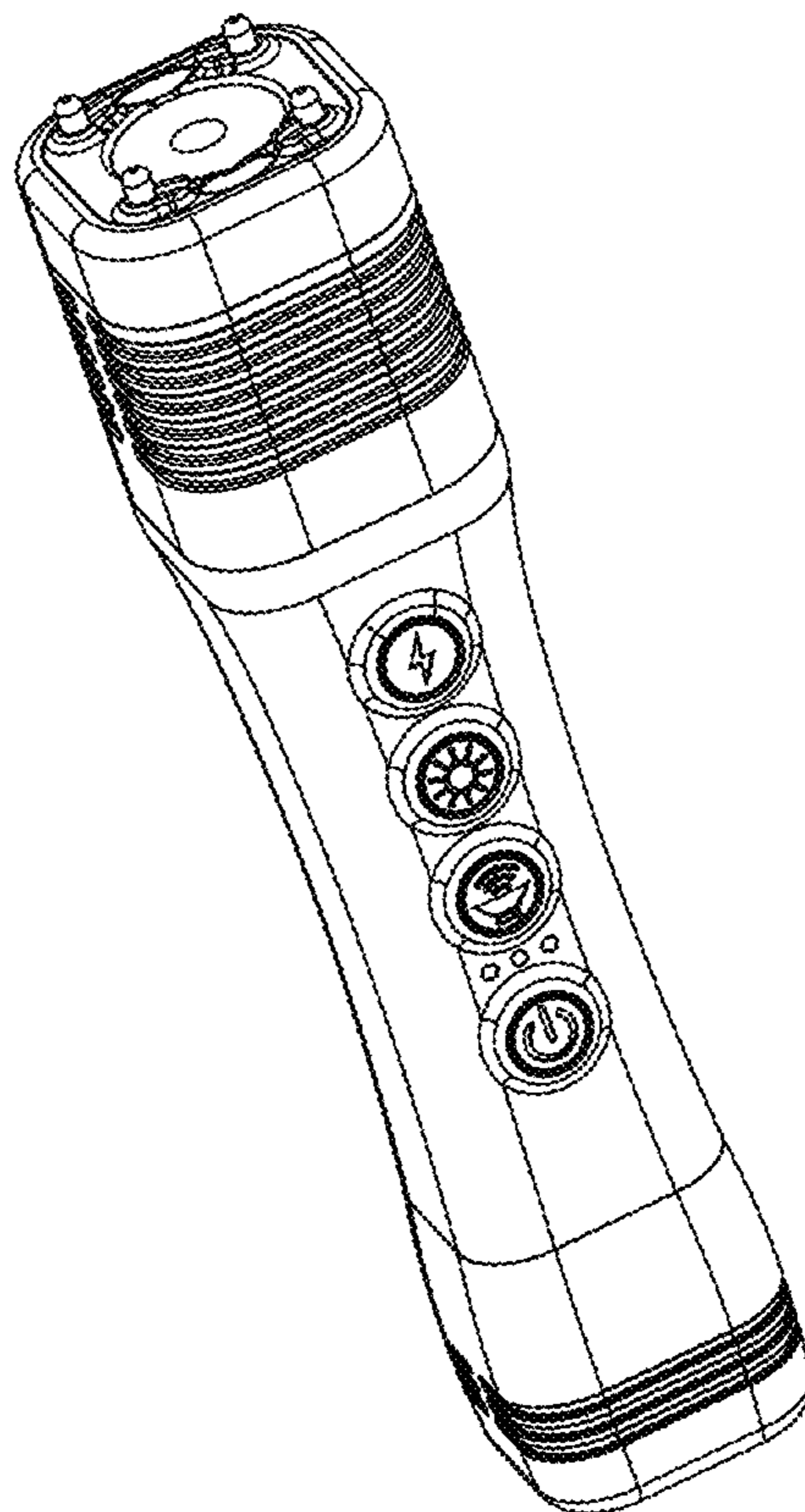

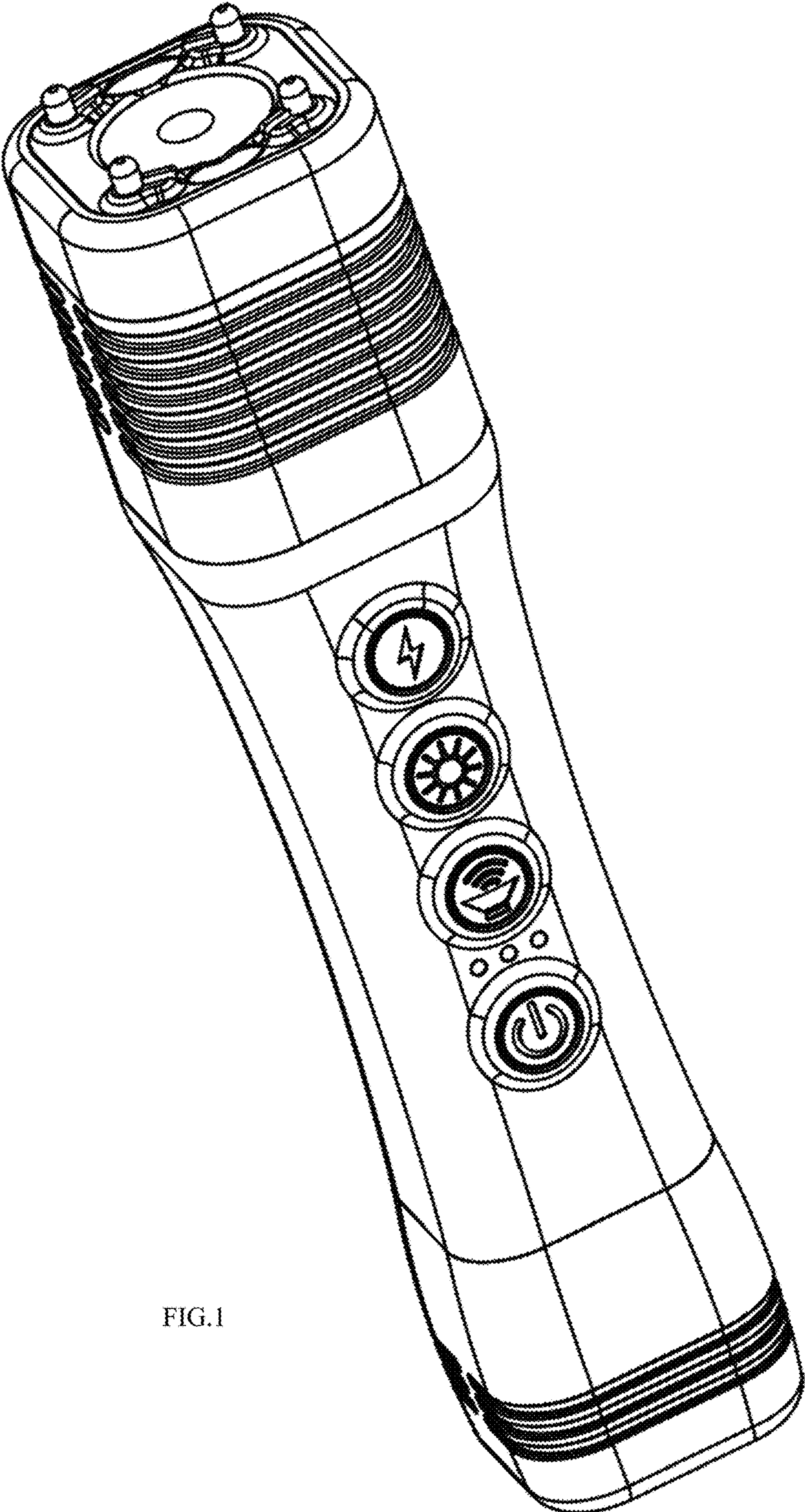

FIG.1

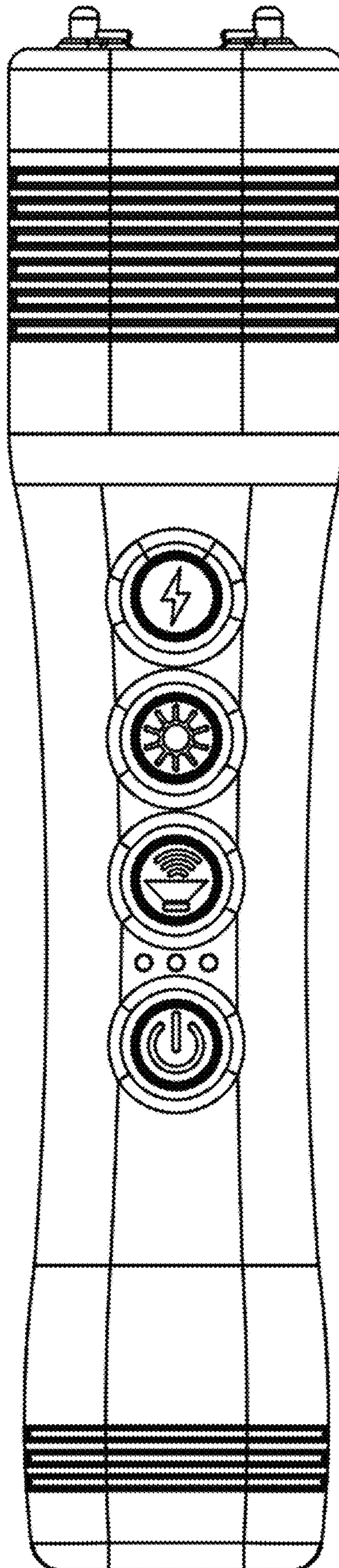

FIG.2

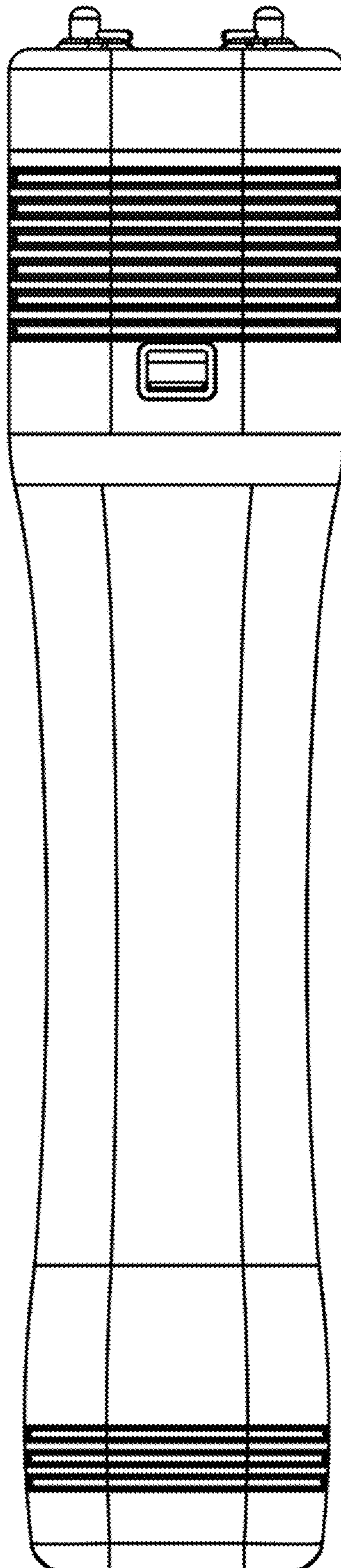

FIG.3

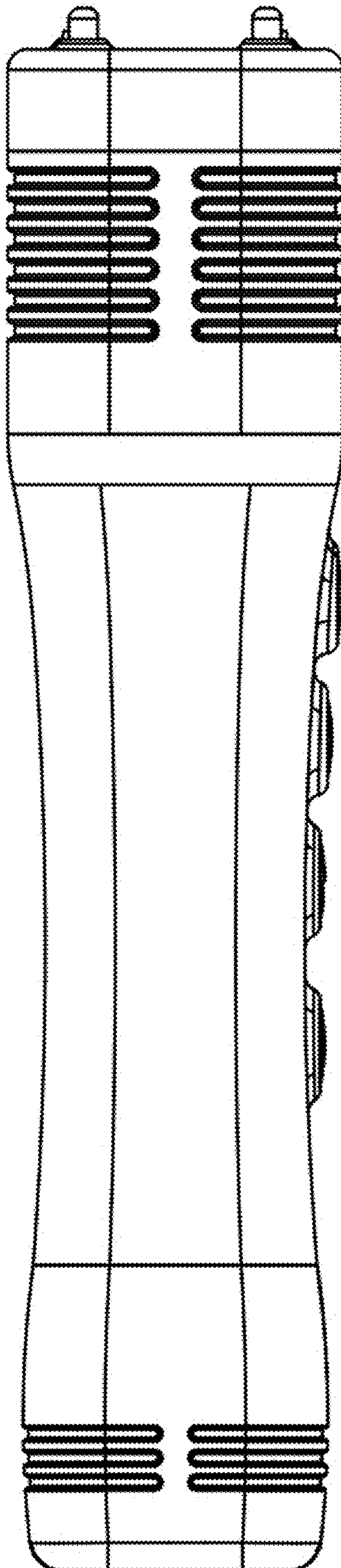

FIG.4

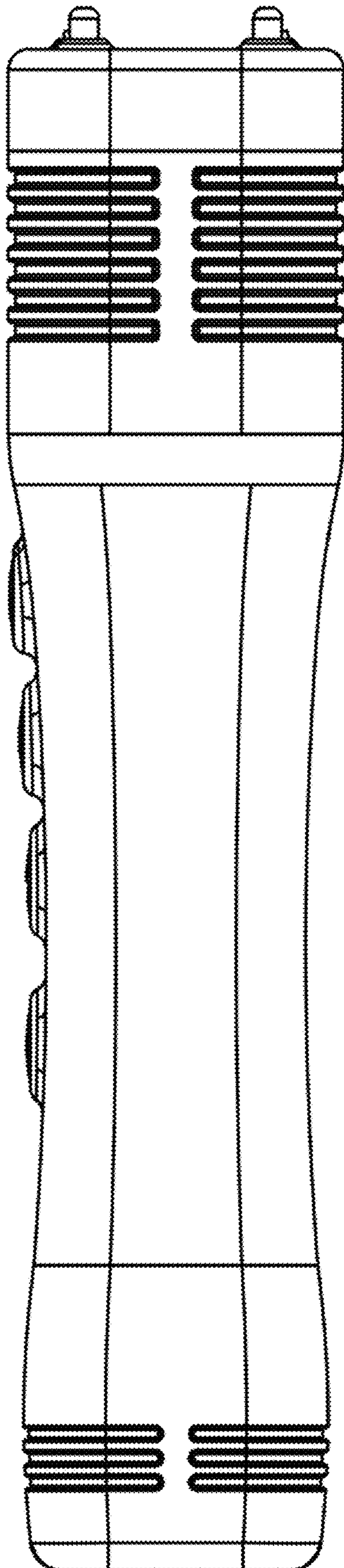

FIG.5

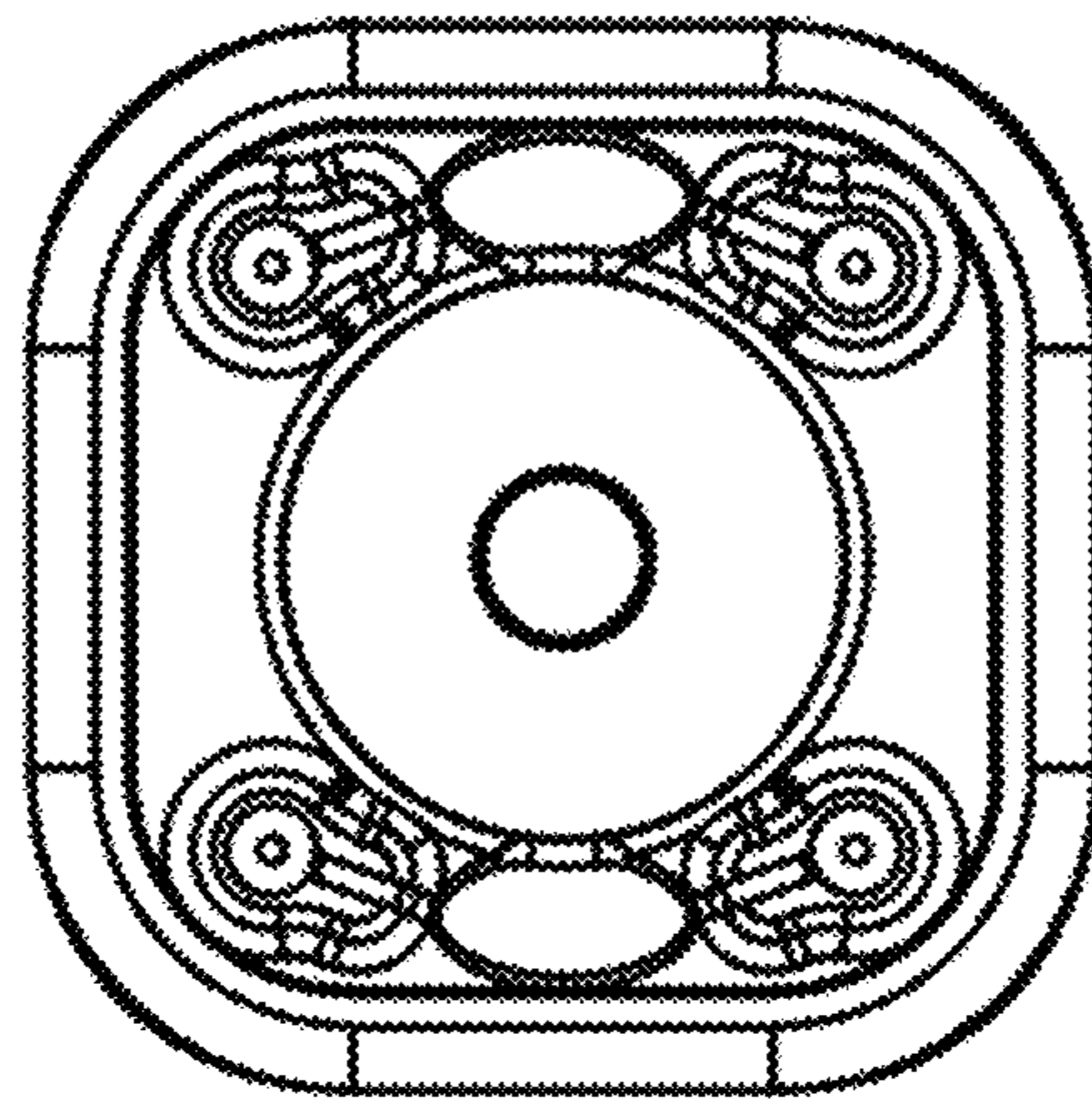

FIG.6

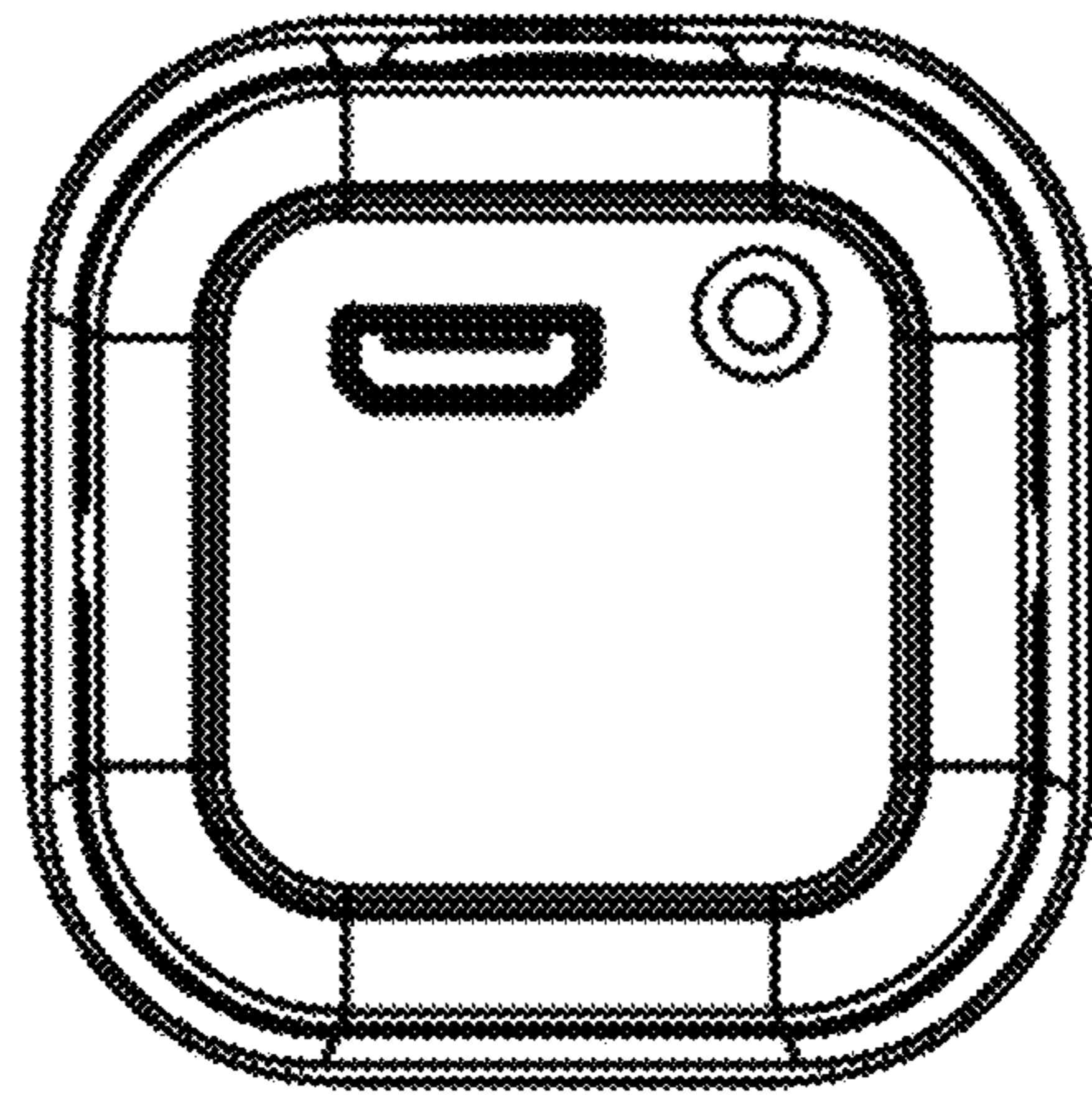

FIG.7