



US00D874570S

(12) **United States Design Patent**
Sandahl Näs

(10) **Patent No.:** **US D874,570 S**

(45) **Date of Patent:** **** Feb. 4, 2020**

- (54) **REVERSE VENDING MACHINE**
- (71) Applicant: **Tomra Systems ASA**, Asker (NO)
- (72) Inventor: **Silje Sandahl Näs**, Bærums Verk (NO)
- (73) Assignee: **TOMRA SYSTEMS ASA**, Asker (NO)
- (**) Term: **15 Years**
- (21) Appl. No.: **29/638,874**
- (22) Filed: **Mar. 1, 2018**
- (30) **Foreign Application Priority Data**

Sep. 1, 2017	(EM)	004195501-0002
Sep. 1, 2017	(EM)	004195501-0003
Sep. 1, 2017	(EM)	004195501-0005
Sep. 1, 2017	(EM)	004195501-0008
Sep. 1, 2017	(EM)	004195501-0009
Sep. 1, 2017	(EM)	004195501-0011

- (51) **LOC (12) Cl.** **20-01**
- (52) **U.S. Cl.**
USPC **D20/1; D20/5**
- (58) **Field of Classification Search**
USPC D20/1-9; D15/79, 81, 89; D99/28
CPC G06Q 20/18; G07F 7/00; G07F 7/025;
G07F 7/08; G07F 7/12; G07F 11/00;
G07F 11/02; G07F 11/62; G07F 11/165;
G07F 7/069; G07F 17/00; G07F 17/40
See application file for complete search history.

(56) **References Cited**
U.S. PATENT DOCUMENTS

5,361,913	A *	11/1994	Melchionna	B07C 5/3412	194/208
D434,449	S *	11/2000	Tandberg	D20/8	
D441,023	S *	4/2001	Vaajakallio	D20/1	
D477,366	S *	7/2003	Tandberg	D20/8	
D504,158	S *	4/2005	Tandberg	D20/8	
D521,073	S *	5/2006	Sandahl	D20/8	

D541,870	S *	5/2007	Tandberg	D20/1
D604,770	S *	11/2009	Sandahl	D20/1
8,851,265	B2 *	10/2014	Morishita	B08B 3/02
					194/208

(Continued)

OTHER PUBLICATIONS

New Tomra, posted at Youtube.com, posted on Jul. 19, 2018, site visited Jun. 20, 2019. online, available from internet: <https://www.youtube.com/watch?v=23ZPm2DGJvk> (Year: 2018).*

Primary Examiner — Mary Ann Calabrese
Assistant Examiner — Catherine Ho
(74) *Attorney, Agent, or Firm* — Buchanan Ingersoll & Rooney P.C.

(57) **CLAIM**
The ornamental design for reverse vending machine, as shown and described.

DESCRIPTION

FIG. 1 is a perspective view of a first embodiment of a reverse vending machine showing my new design; FIG. 2 is a front elevational view thereof; FIG. 3 is a right side elevational view thereof; FIG. 4 is a left side elevational view thereof; FIG. 5 is a top plan view thereof; FIG. 6 is a rear elevational view thereof; FIG. 7 is a bottom plan view thereof; FIG. 8 is a perspective view of a second embodiment of a reverse vending machine, showing my new design; FIG. 9 is a front plan view thereof; FIG. 10 is a right side view thereof; FIG. 11 is a left side view thereof; FIG. 12 is a top plan view thereof; FIG. 13 is a rear plan view thereof; and, FIG. 14 is a bottom plan view thereof. The broken lines shown in the drawings depict portions of the reverse vending machine that form no part of the claimed design.

1 Claim, 14 Drawing Sheets

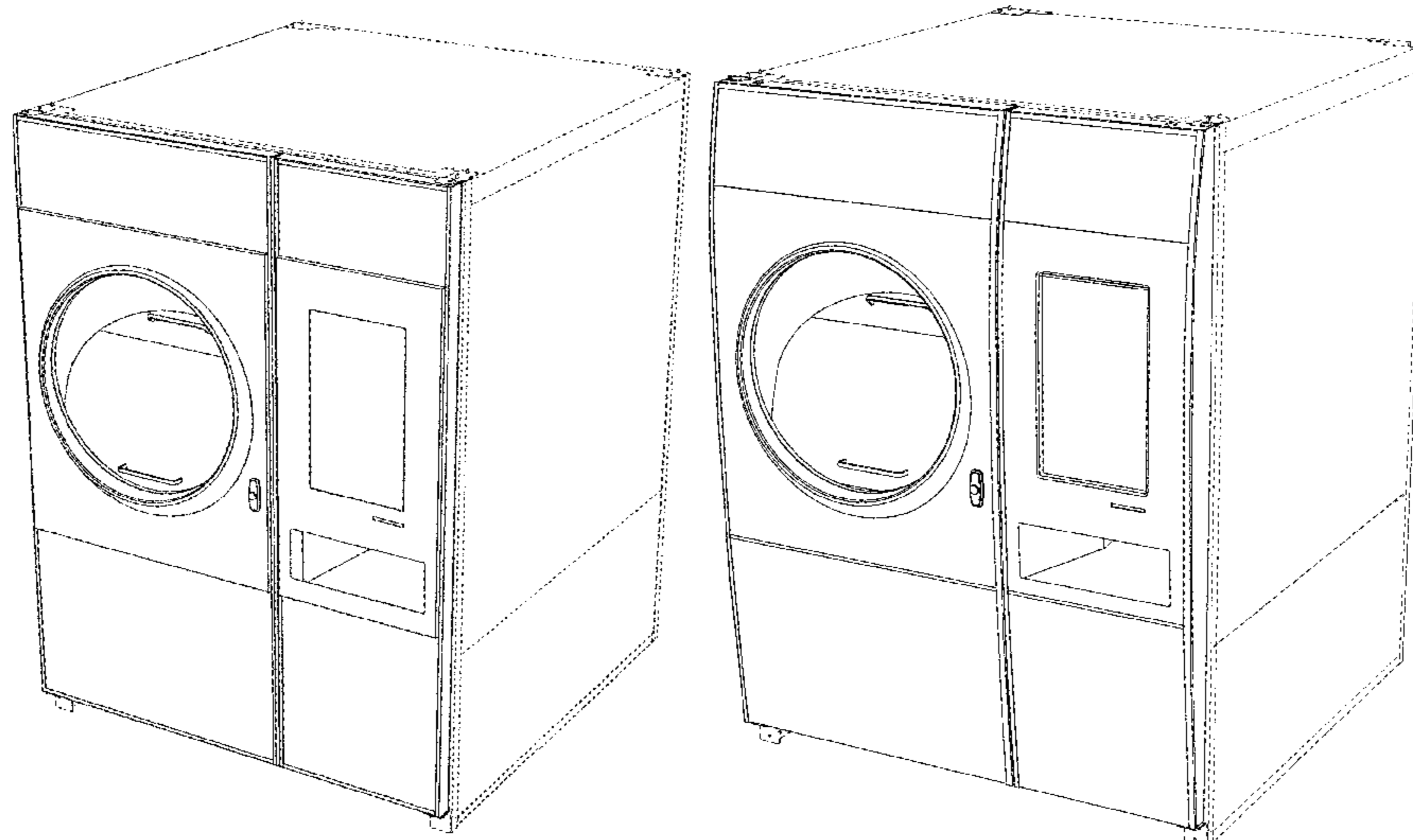

(56)

References Cited

U.S. PATENT DOCUMENTS

9,189,911	B2 *	11/2015	Kavli	G07F 7/0609
D753,227	S	4/2016	Sandahl	
D827,717	S *	9/2018	Sandahl	D20/8
10,210,693	B2 *	2/2019	Hannawa	B30B 9/321
2019/0180551	A1 *	6/2019	Hannawa	B30B 9/321

* cited by examiner

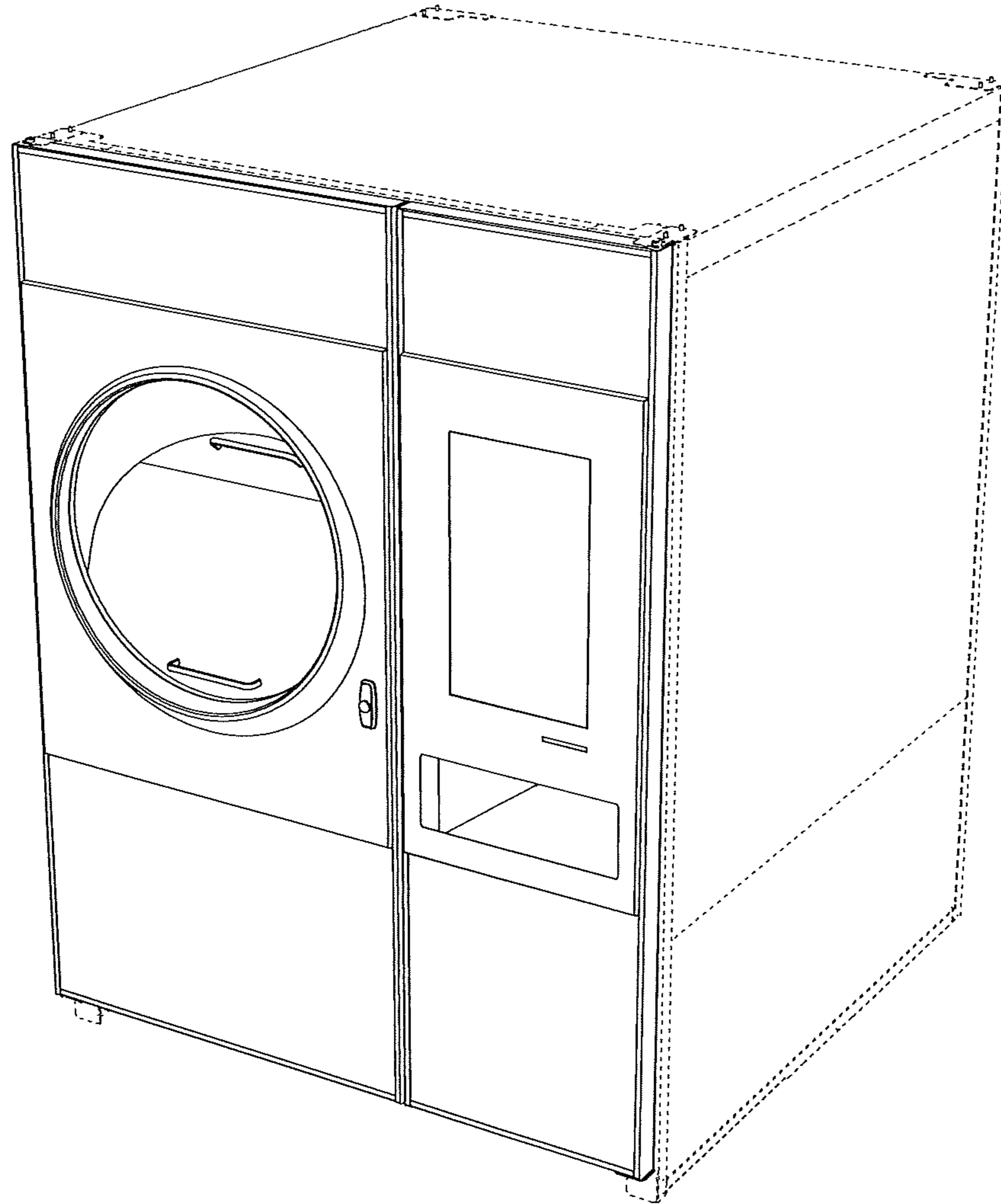

Figure 1

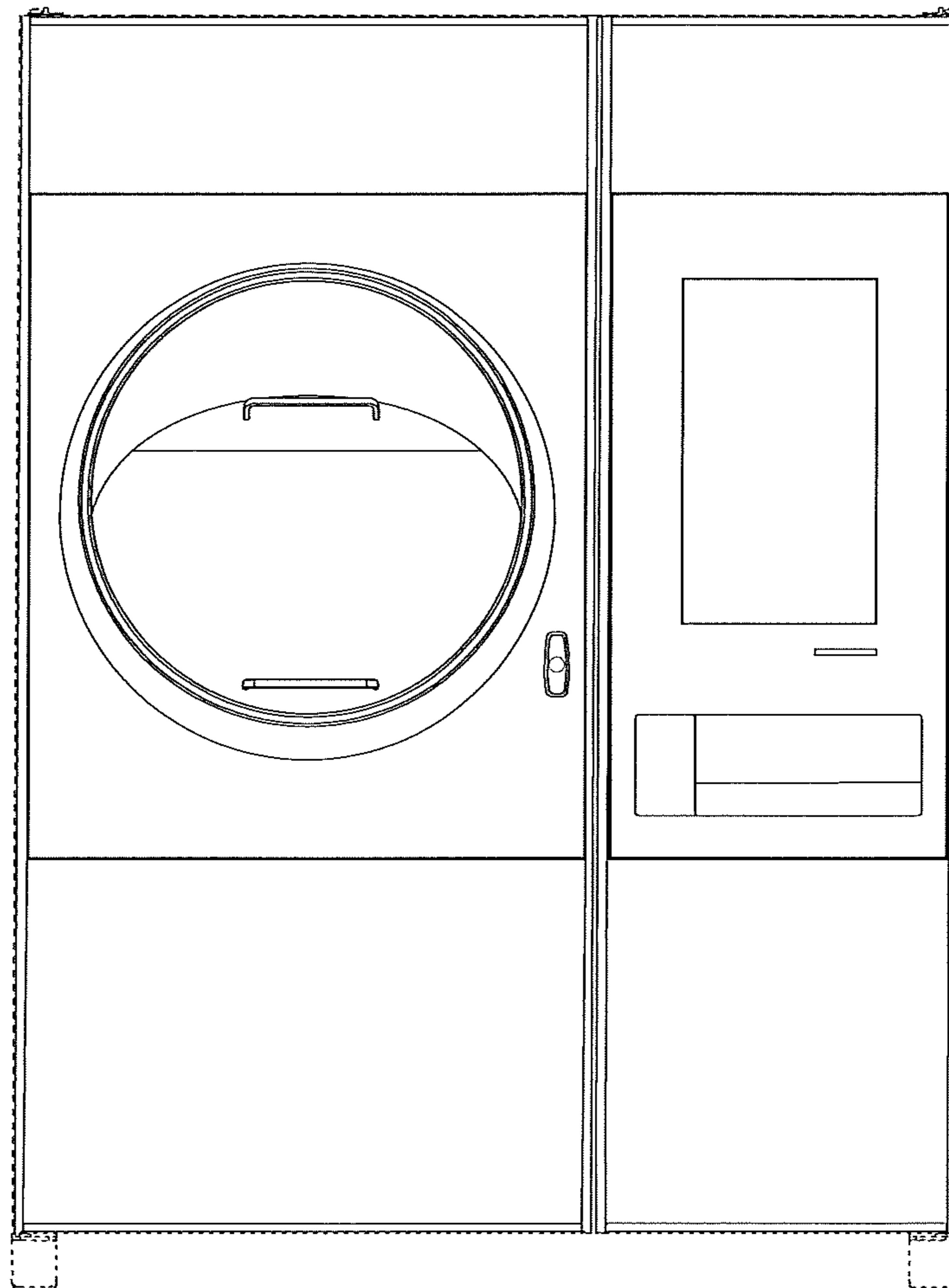

Figure 2

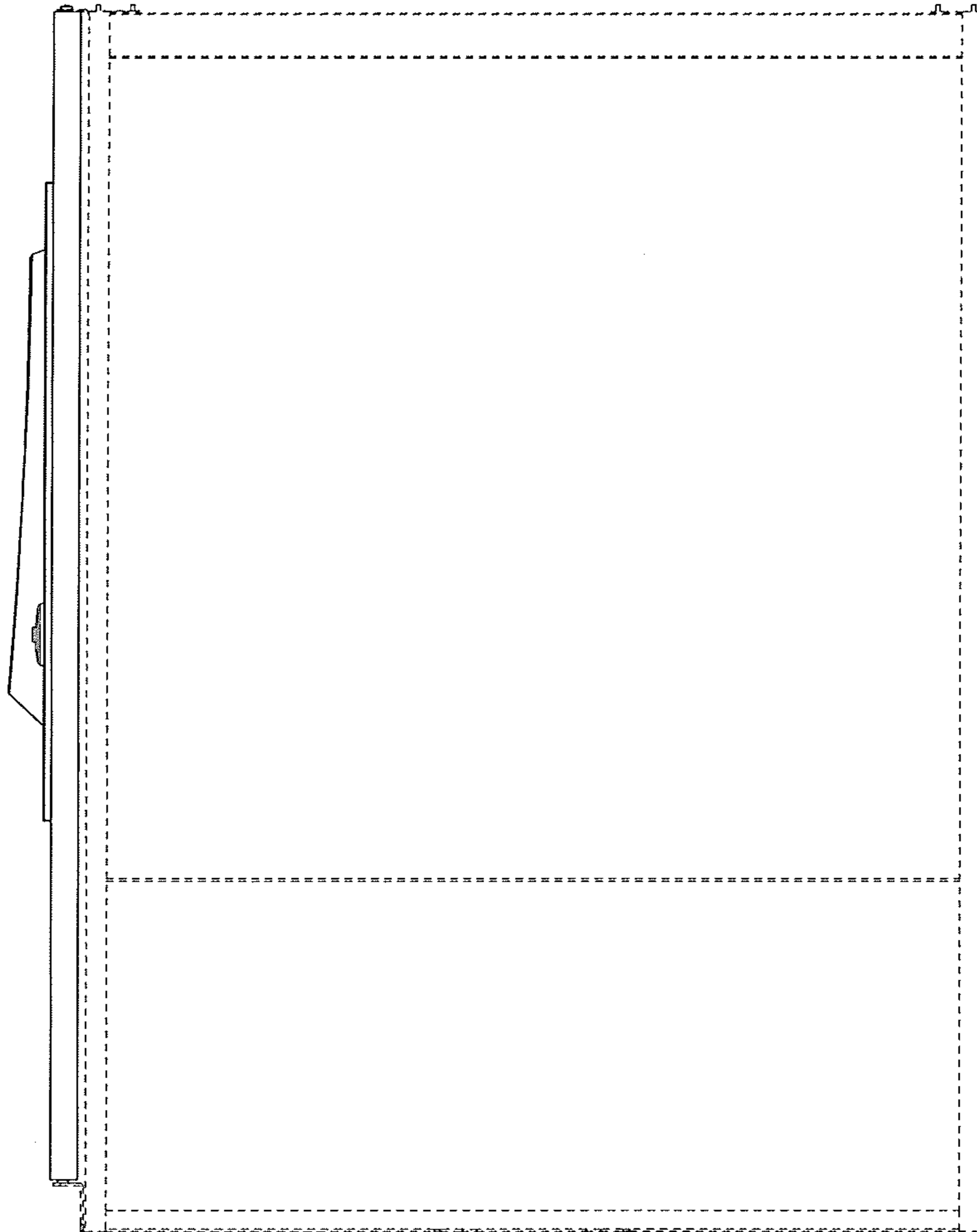

Figure 3

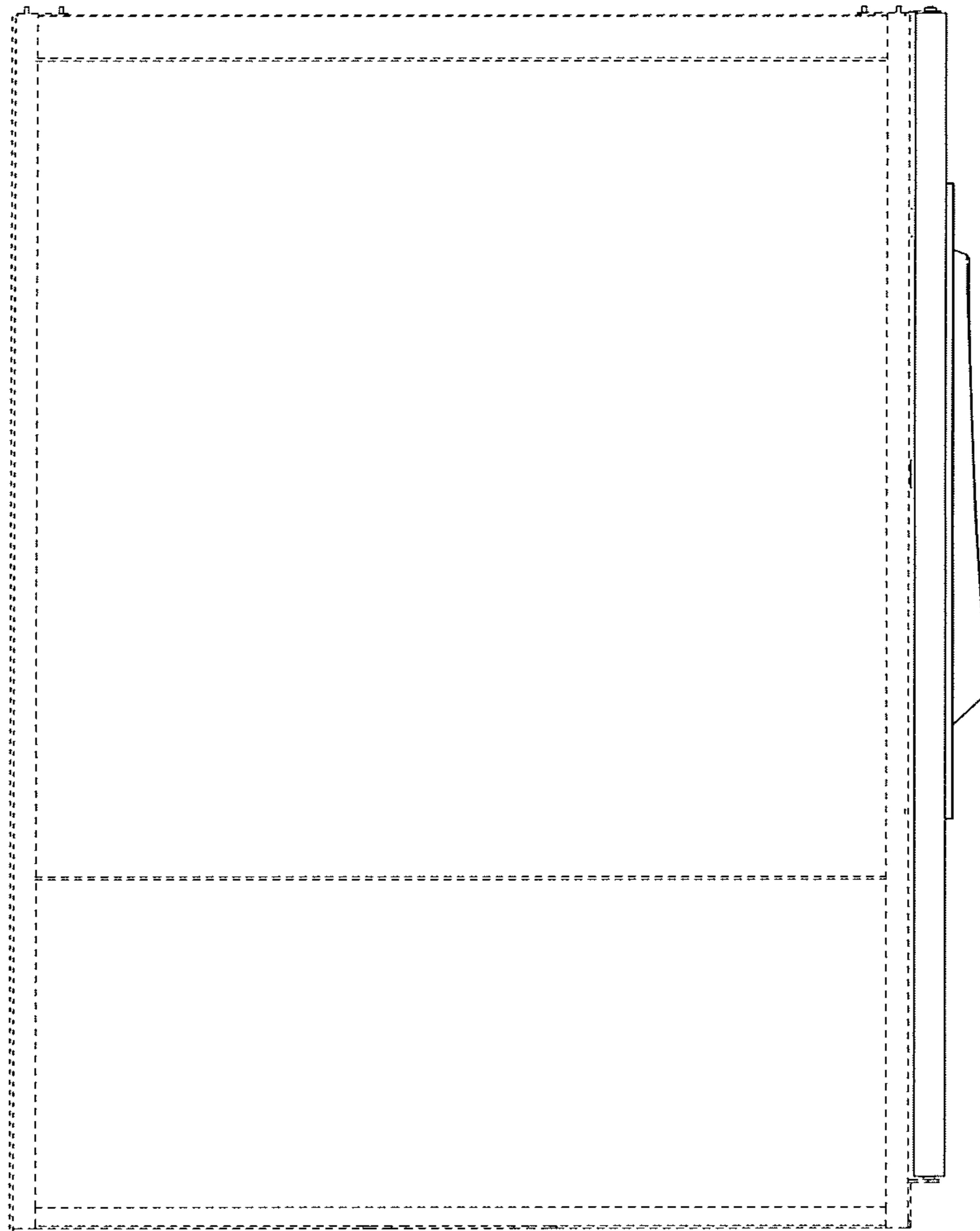

Figure 4

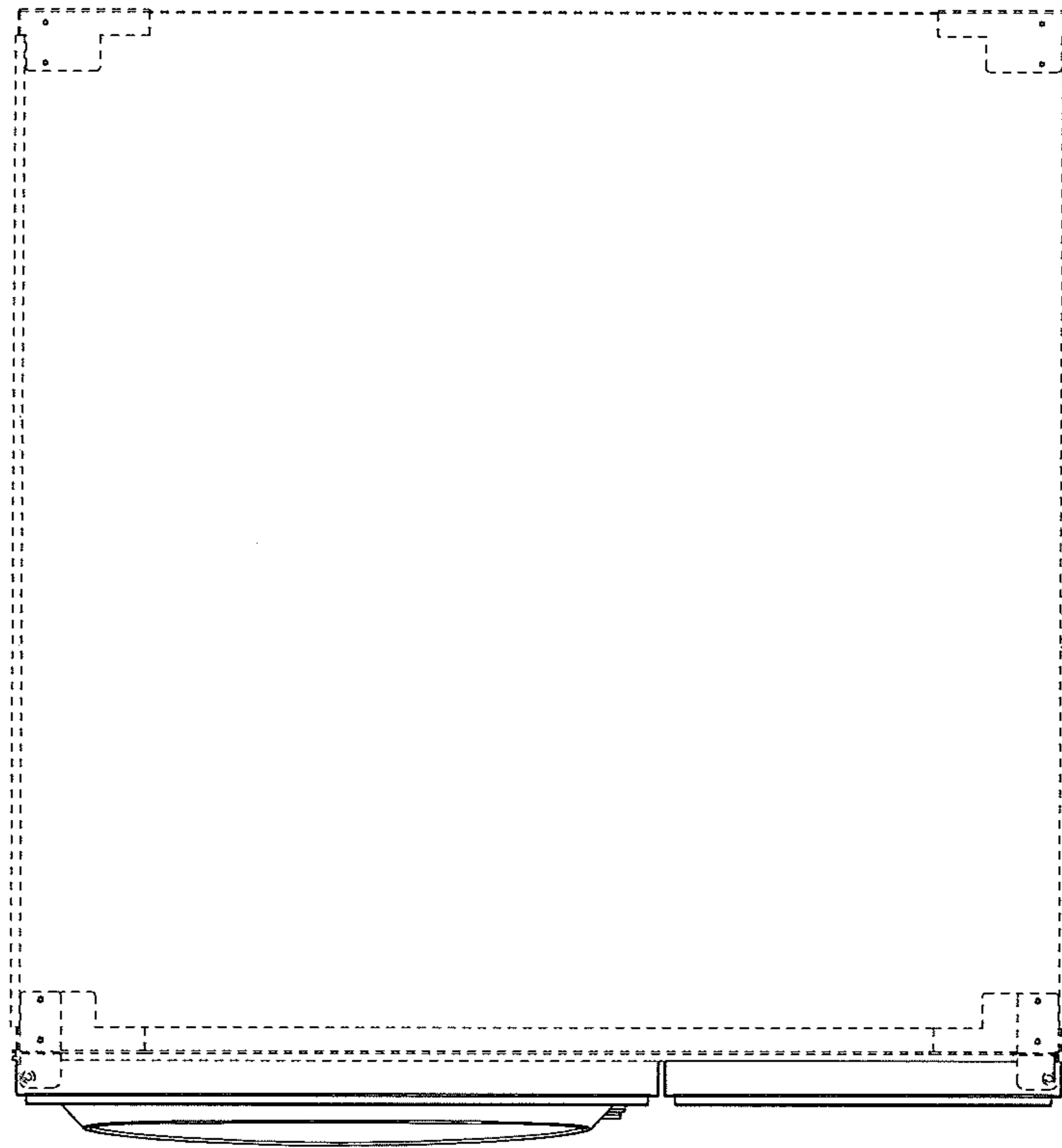

Figure 5

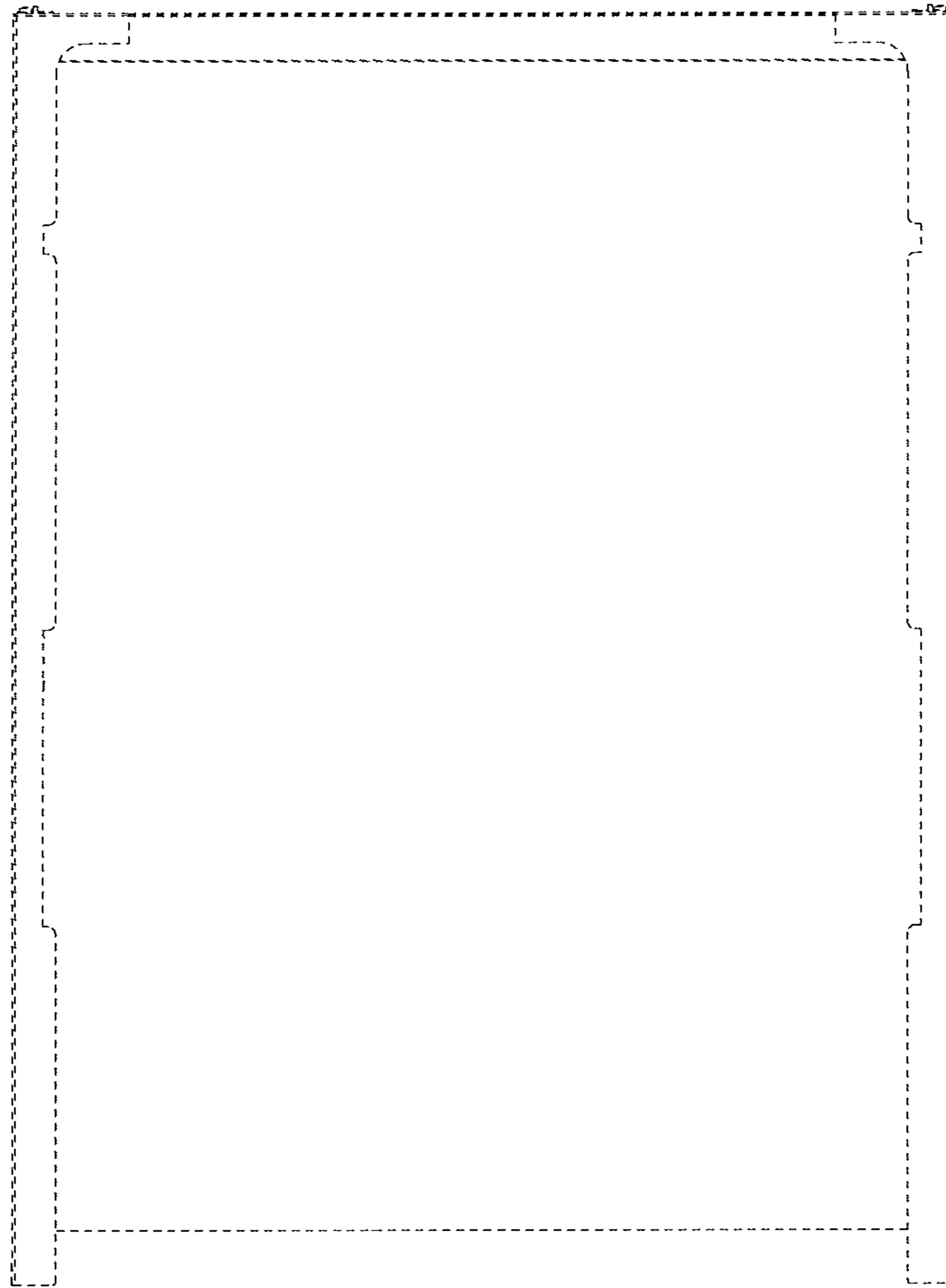

Figure 6

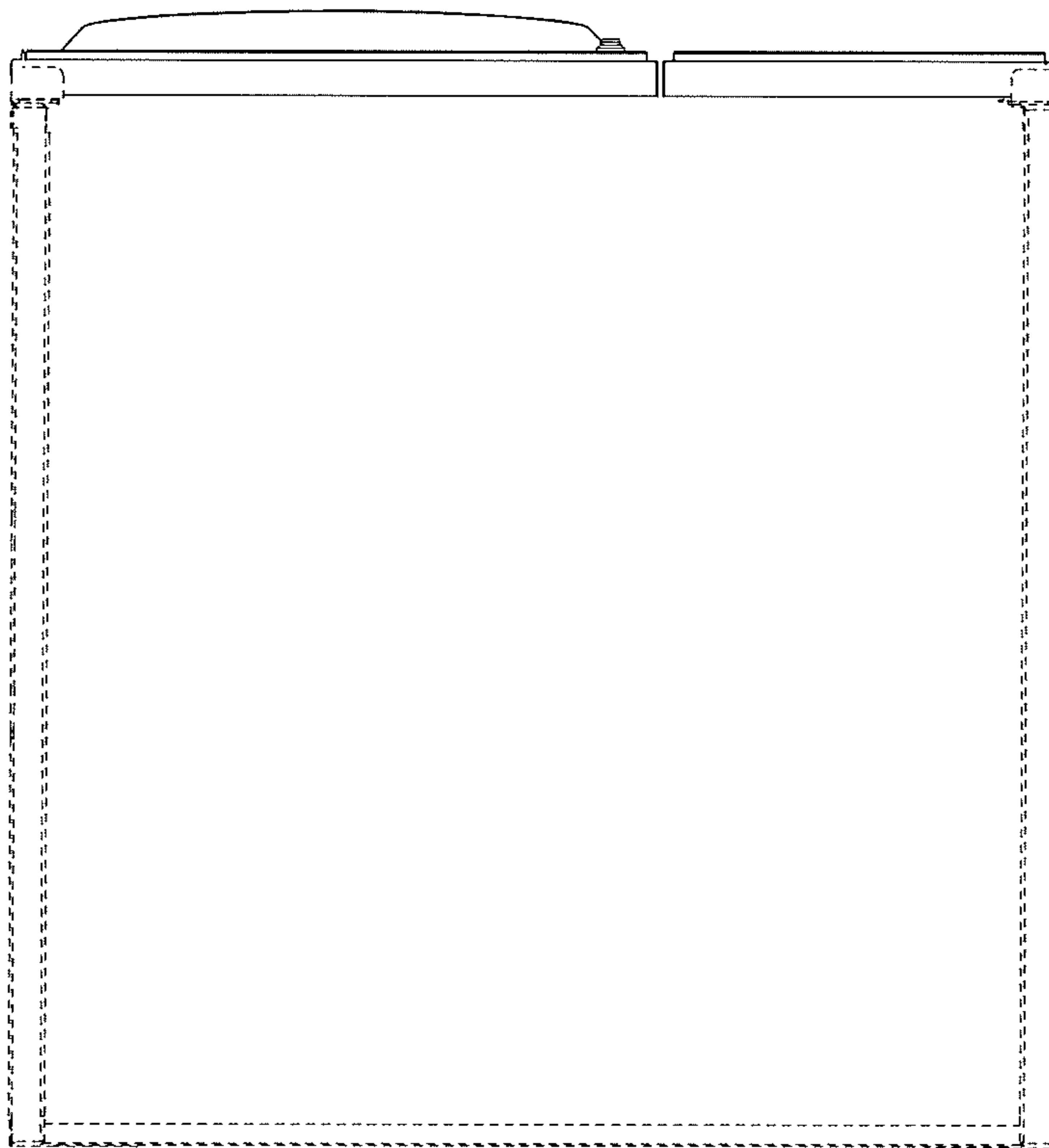

Figure 7

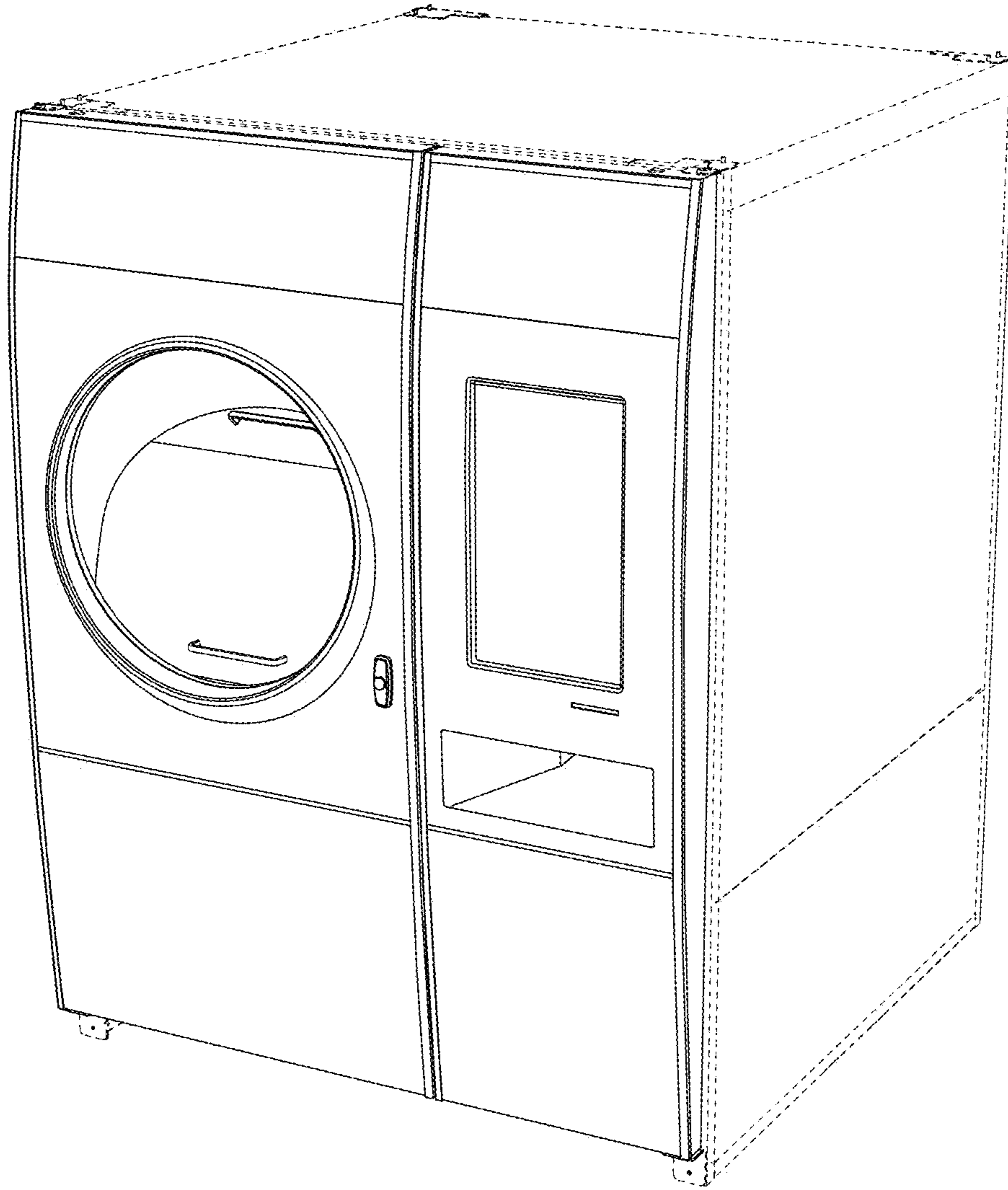

Figure 8

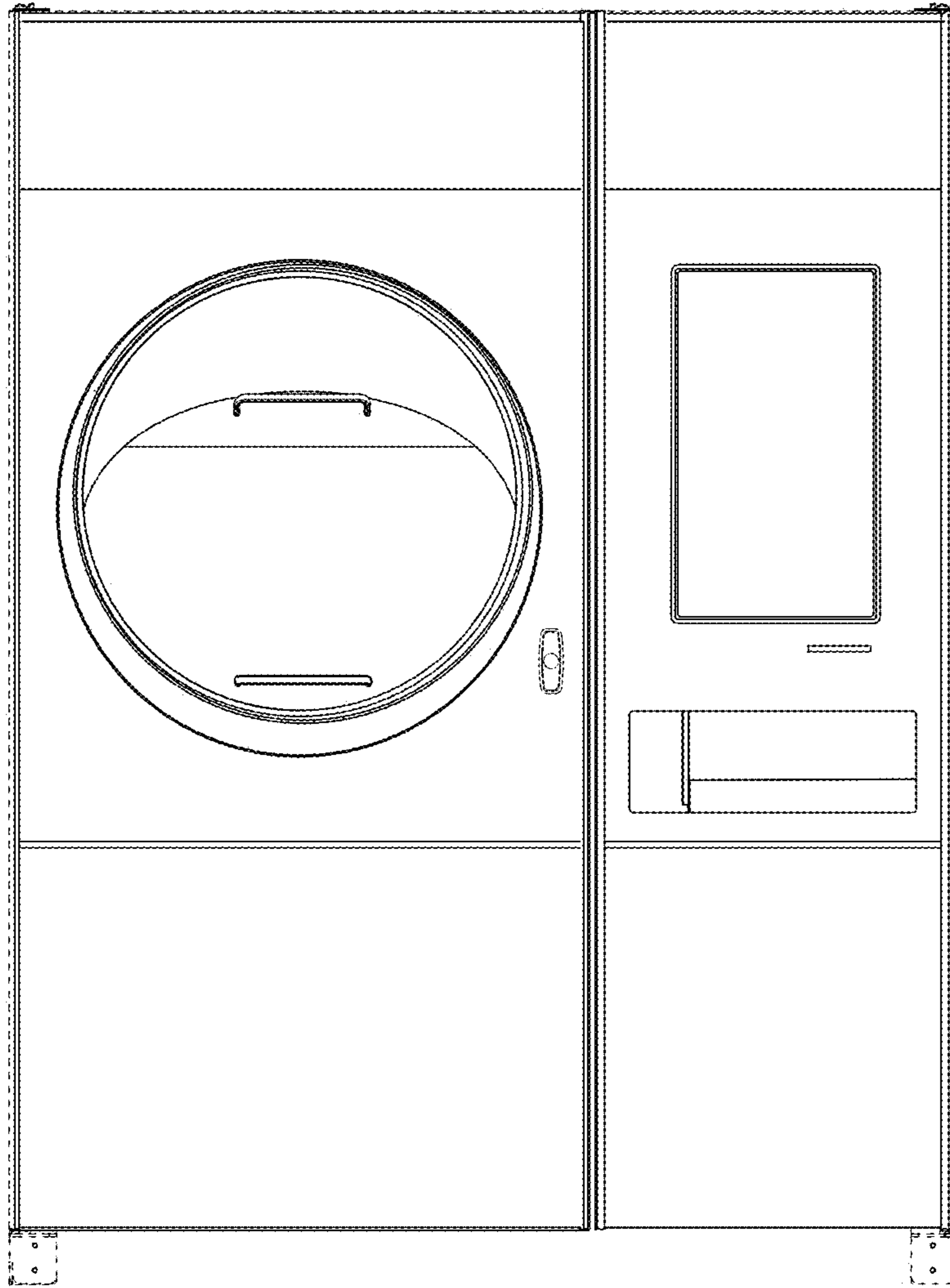

Figure 9

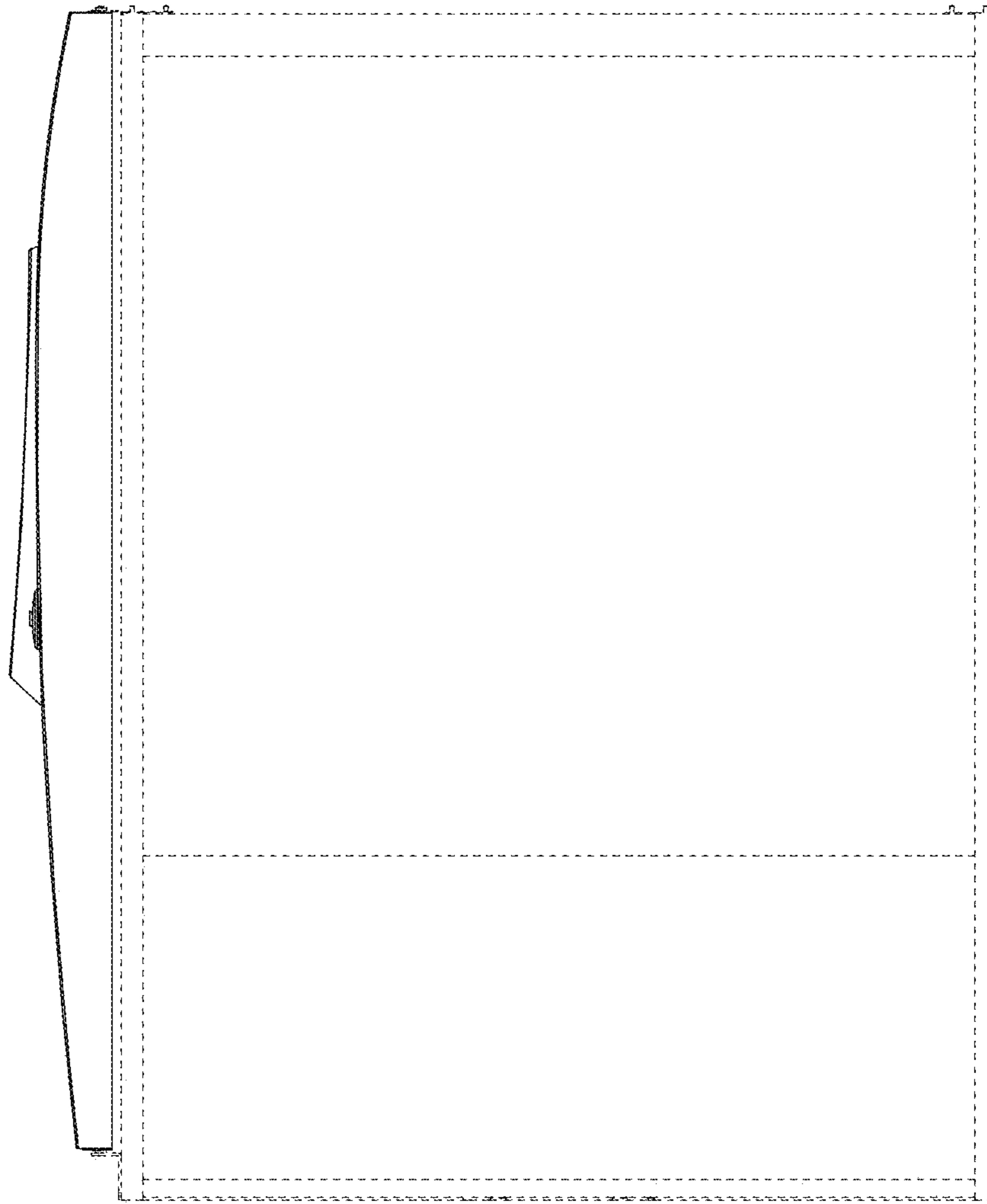

Figure 10

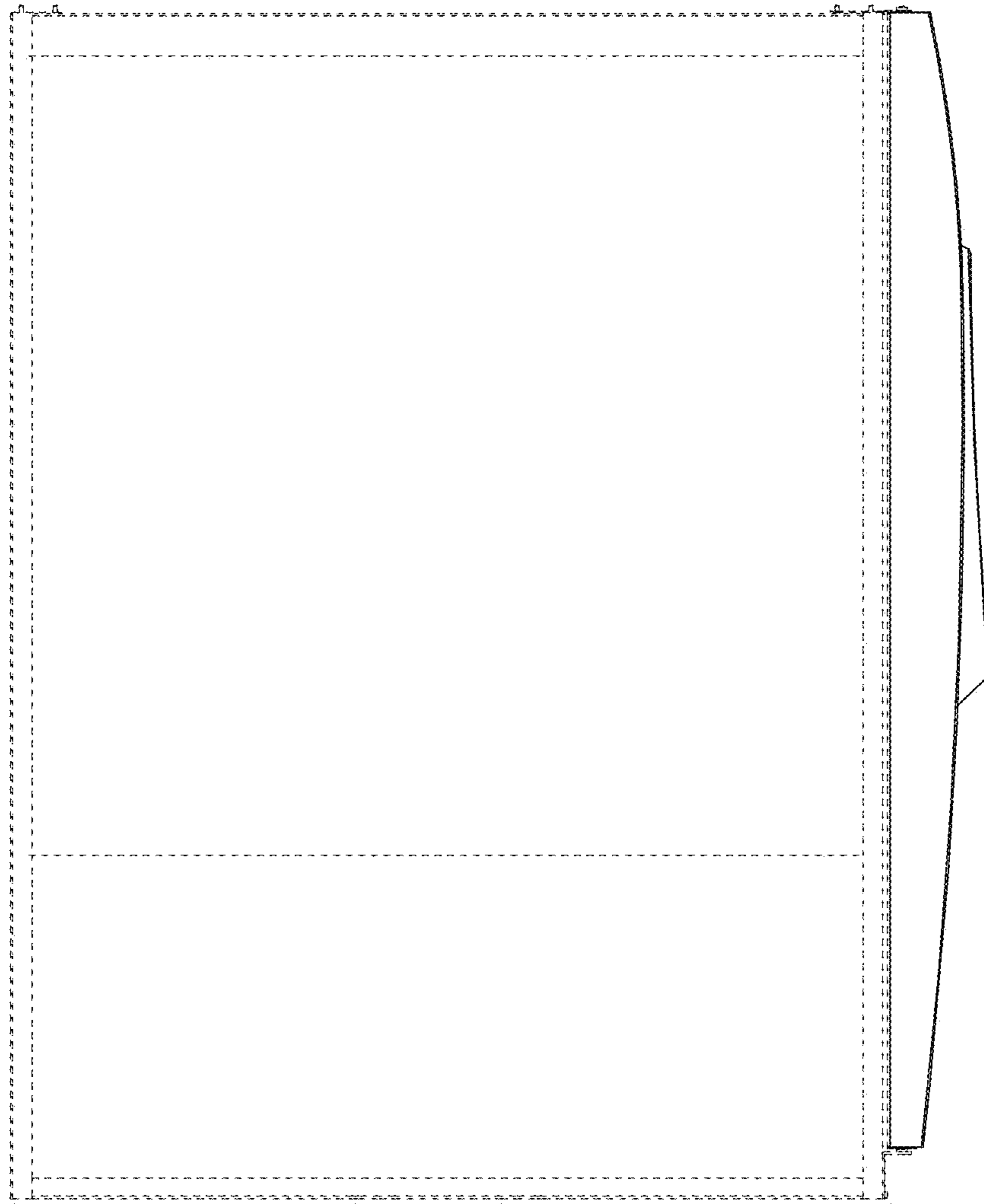

Figure 11

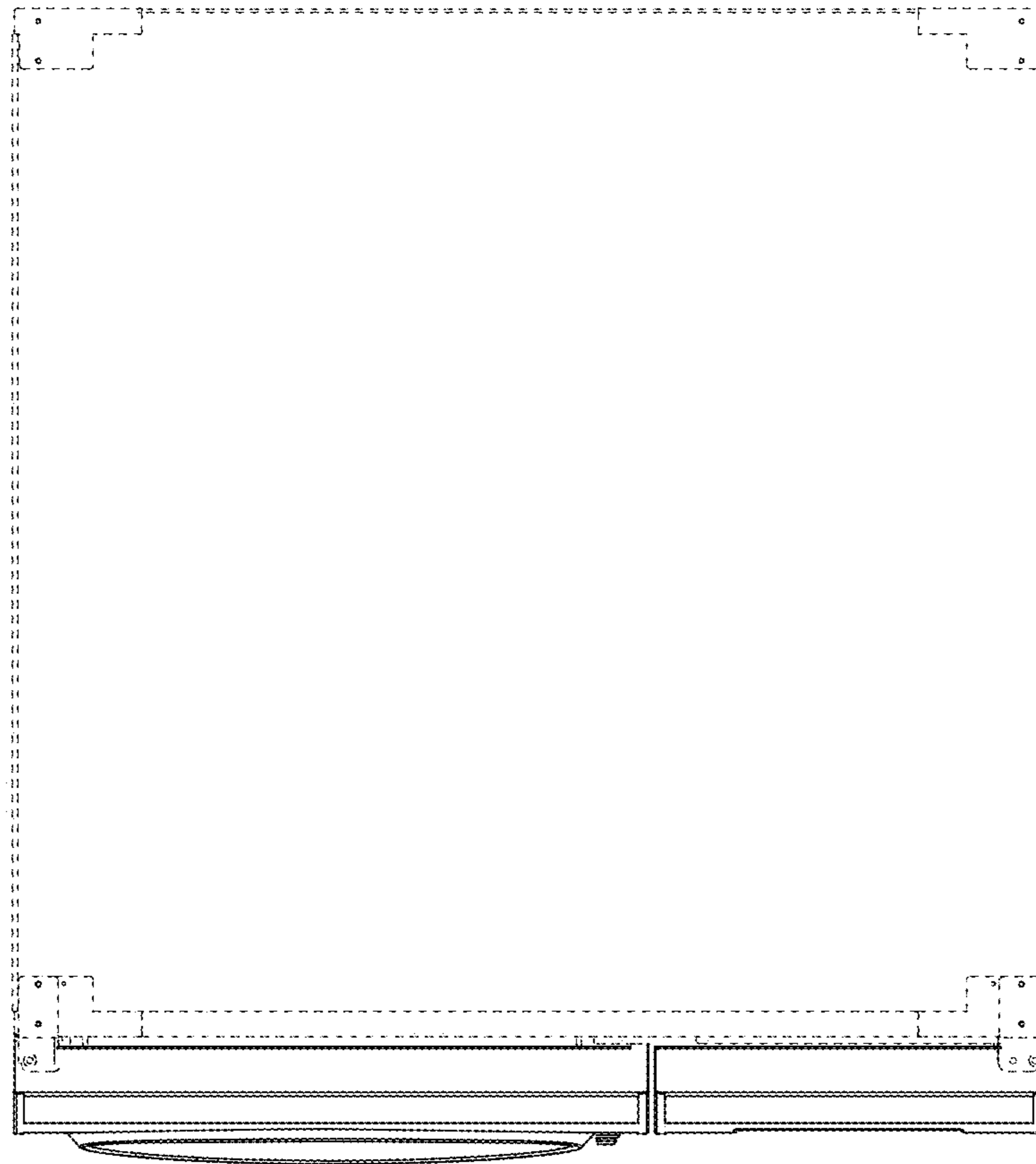

Figure 12

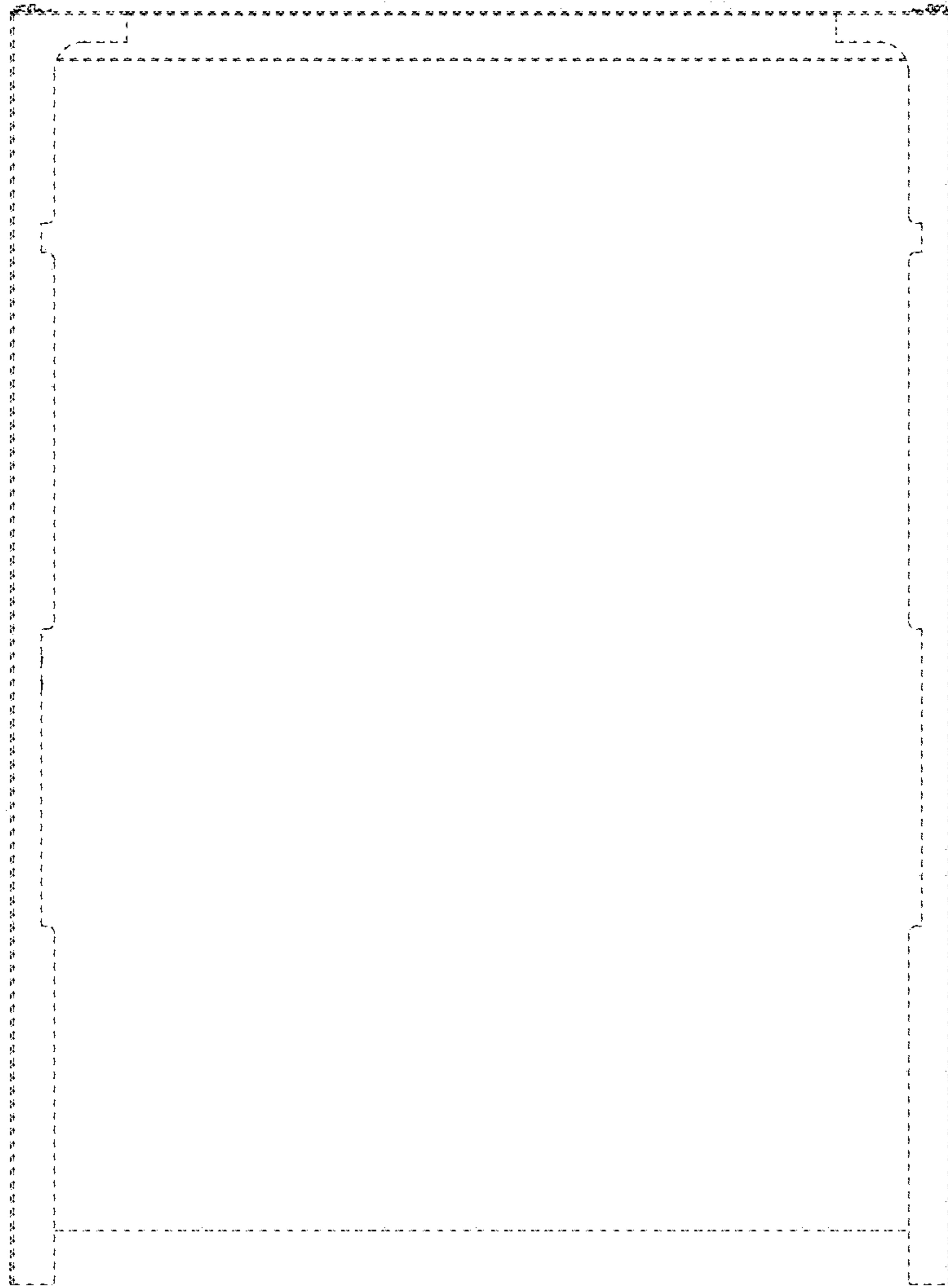

Figure 13

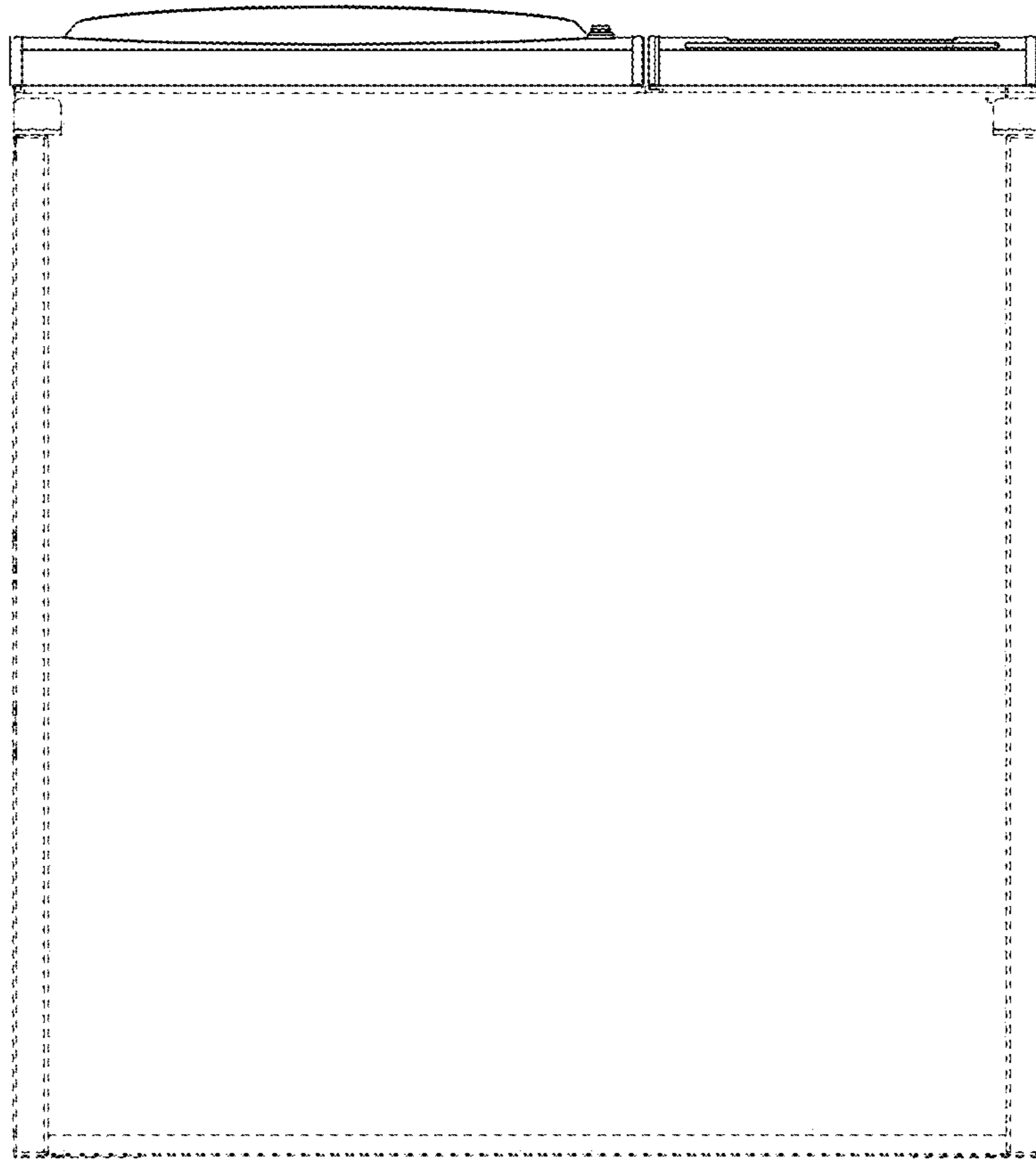

Figure 14