



US00D874312S

(12) **United States Design Patent** (10) **Patent No.:** **US D874,312 S**
Unruh (45) **Date of Patent:** **** *Feb. 4, 2020**

(54) **JEWELRY ASSEMBLY WITH REMOVABLE TILE**

(71) Applicant: **Lori Unruh**, Floyds Knobs, IN (US)

(72) Inventor: **Lori Unruh**, Floyds Knobs, IN (US)

(*) Notice: This patent is subject to a terminal disclaimer.

(**) Term: **15 Years**

(21) Appl. No.: **29/627,089**

(22) Filed: **Nov. 22, 2017**

Related U.S. Application Data

(63) Continuation of application No. 15/602,559, filed on May 23, 2017.

(51) **LOC (12) Cl.** **11-01**

(52) **U.S. Cl.**
USPC **D11/6**

(58) **Field of Classification Search**
USPC D11/1-29, 34, 36-43, 47, 76-79, 86;
D14/344; D28/41

CPC A44C 5/00; A44C 5/0007; A44C 5/0023;
A44C 5/003; A44C 5/0038; A44C
5/0046; A44C 5/0053; A44C 5/0061;
A44C 5/0069; A44C 5/0076; A44C
5/0084; A44C 5/0092; A44C 5/02; A44C
5/022; A44C 5/025; A44C 5/027; A44C
5/04; A44C 5/08; A44C 5/12; A44C 1/00;
A44C 13/00; A44C 15/001; A44C
15/003; A44C 15/0035; A44C 15/0045;
A44C 15/005; A44C 15/0055; A44C
15/006; A44C 23/00; A44C 25/001; A44C
25/007; A44C 9/00; A44C 9/0038; A44C
9/0046; A44C 9/0053; A44C 9/0061;
A44C 9/0069; A44C 9/02

See application file for complete search history.

(56) **References Cited**

U.S. PATENT DOCUMENTS

365,853 A * 7/1887 Palmer A44C 11/002
D11/8
1,681,687 A * 8/1928 Schraysshuen A44C 5/0092
D11/6

(Continued)

OTHER PUBLICATIONS

Blessings Bracelet Private Party, published on Feb. 27, 2016, online. Site visited: Jan. 31, 2019. Internet URL: <"https://bid.beckortauctions.com/view-auctions/catalog/id/11267/lot/1509852/Blessings-Bracelet-Private-Party"> (Year: 2016).*

(Continued)

Primary Examiner — L. Martinez

(74) *Attorney, Agent, or Firm* — Middleton Reutlinger

(57) **CLAIM**

The ornamental design for a jewelry assembly with a removable tile, as shown and described.

DESCRIPTION

FIG. 1 is a top perspective view of a first embodiment of a jewelry assembly with a removable tile;
FIG. 2 is a first side view of the jewelry assembly with a removable tile of FIG. 1;
FIG. 3 is a second side view of the jewelry assembly with a removable tile of FIG. 1;
FIG. 4 is a top view of the jewelry assembly with a removable tile of FIG. 1;
FIG. 5 is a bottom view of the jewelry assembly with a removable tile of FIG. 1;
FIG. 6 is a third side view of the jewelry assembly with a removable tile of FIG. 1; and,
FIG. 7 is a fourth side view of the jewelry assembly with a removable tile of FIG. 1.

(Continued)

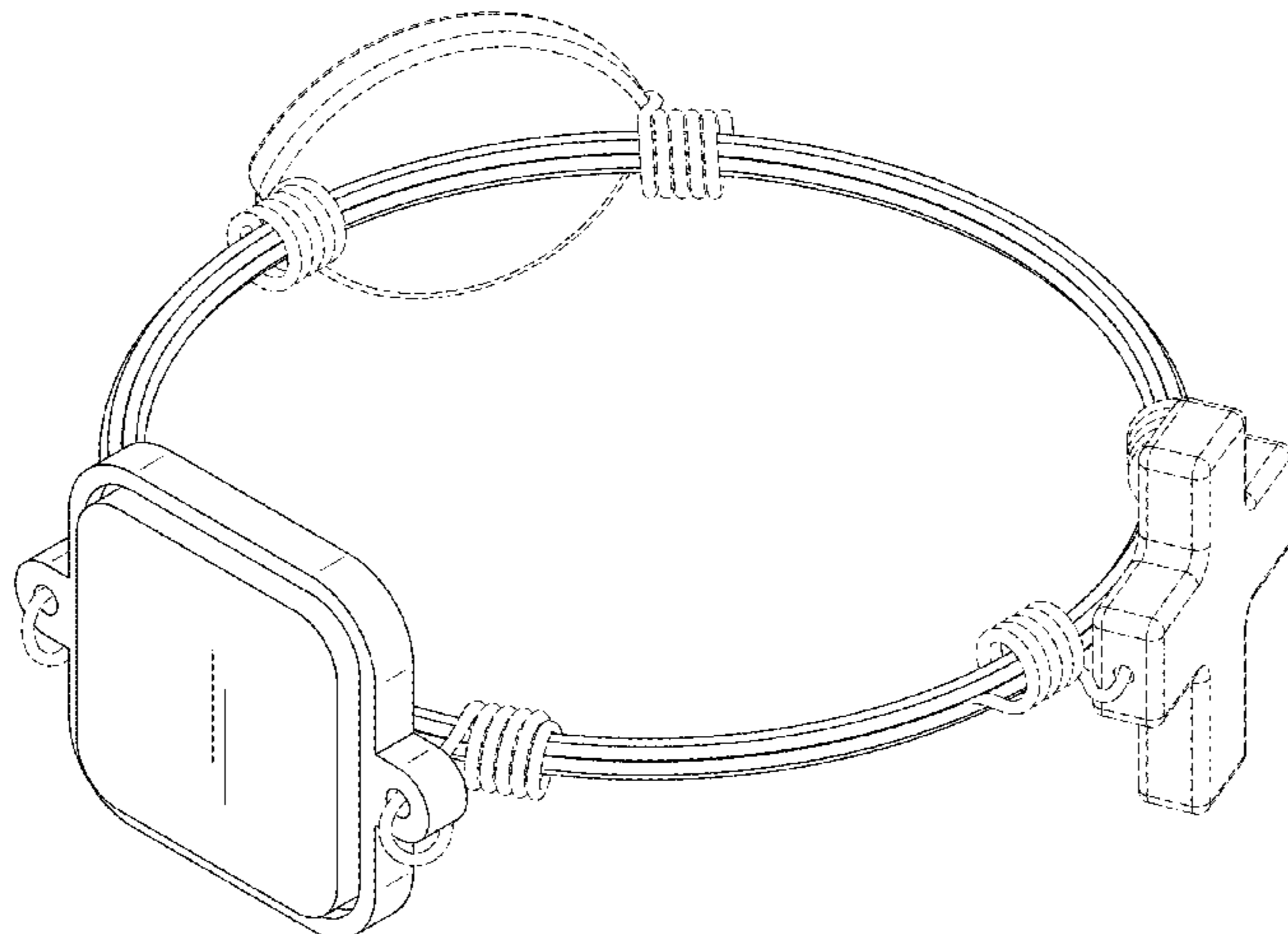

The broken lines in the drawings represent portions of the jewelry assembly with removable tile that form no part of the claimed design.

1 Claim, 7 Drawing Sheets

(56)

References Cited

U.S. PATENT DOCUMENTS

D80,786 S * 3/1930 Granat D11/86
 D108,250 S * 2/1938 Sternberg D11/8
 2,378,755 A * 6/1945 Dowling A44C 5/00
 D142,111 S * 8/1945 Nazare D11/9
 D158,918 S * 6/1950 Winn D11/3
 2,775,093 A * 12/1956 Kundert A44C 5/102
 D11/17
 3,025,820 A 3/1962 Rosenthal
 D224,257 S * 7/1972 Lee D11/4
 D257,021 S * 9/1980 Barr D11/34
 4,570,308 A 2/1986 Weisgerber
 D287,949 S * 1/1987 Bulgari D11/6
 D334,152 S * 3/1993 Rozenwasser D11/13
 5,675,874 A 10/1997 Chen
 5,921,110 A 7/1999 Middendorff et al.
 D463,308 S * 9/2002 Skiles D11/3
 D472,840 S * 4/2003 Visick D11/3
 D475,316 S * 6/2003 Skiles D11/1
 D495,869 S * 9/2004 Troitski D3/208
 D502,661 S * 3/2005 Rapport D11/3
 D502,662 S * 3/2005 Rapport D11/3
 D503,646 S * 4/2005 Rapport D11/3
 7,028,507 B2 * 4/2006 Rapport A44C 5/003
 63/18
 7,409,837 B2 8/2008 Smith
 7,467,444 B1 * 12/2008 Johnson, Sr. A44C 23/00
 63/1.14
 7,941,988 B2 5/2011 Mars
 D640,948 S * 7/2011 Quigley D11/3
 D653,582 S * 2/2012 Smith D11/79
 D658,087 S * 4/2012 Rafaelian D11/3
 D658,088 S * 4/2012 Rafaelian D11/3
 D664,466 S * 7/2012 Rafaelian D11/3
 D670,189 S * 11/2012 Puglisi D11/3
 D678,102 S * 3/2013 Rafaelian D11/3
 D680,019 S * 4/2013 Puglisi D11/3
 D681,498 S * 5/2013 Kornerup D11/16
 D682,727 S * 5/2013 Bulgari D11/16

D682,728 S * 5/2013 Bulgari D11/34
 D692,340 S * 10/2013 Mejia D11/3
 8,544,705 B2 10/2013 Su
 D712,773 S * 9/2014 Mounce D11/4
 D722,902 S * 2/2015 Mihalyo D11/3
 D724,985 S * 3/2015 Blondet D11/5
 D724,986 S * 3/2015 Blondet D11/5
 9,113,677 B2 8/2015 Anderson et al.
 9,326,571 B2 5/2016 Nevatia et al.
 D762,125 S * 7/2016 Gruosi D11/3
 9,398,790 B1 * 7/2016 Ketcher A44C 15/005
 D785,246 S * 4/2017 Ethington D28/41
 D823,708 S * 7/2018 Tsai D11/2
 D831,523 S * 10/2018 Barley D11/4
 2005/0150035 A1 * 7/2005 Marks A44C 25/007
 2/338
 2008/0229641 A1 * 9/2008 Slutterback A44C 1/00
 40/773
 2011/0194276 A1 * 8/2011 Au A44C 5/0007
 63/1.13
 2013/0036767 A1 2/2013 Mehta
 2014/0259303 A1 9/2014 Eliason
 2015/0216271 A1 8/2015 Mueller
 2016/0095396 A1 * 4/2016 Pedersen A44C 25/007
 63/23
 2016/0198817 A1 7/2016 Berke et al.
 2017/0035162 A1 2/2017 Leshem
 2018/0125182 A1 * 5/2018 Barouch A44C 5/20

OTHER PUBLICATIONS

Local designer has an eye out for fall colors, published on Aug. 19, 2016, online. Site visited on Jan. 31, 2019. Internet URL: <“https://www.courier-journal.com/story/life/shopping/stylemaker/2016/08/19/local-designers-has-eye-out-fall-colors/86948378”> (Year: 2016).
 Cadella’s Company Website, published on May 21, 2017, online. Site visited on Feb. 1, 2019. Internet URL: <“https://web.archive.org/web/20170521224305/http://cadellas.com”> (Year: 2017).
 Amazon; Floating Locket Lanyard Badge Holder With Interchangeable Face Plates and 6 Charms; https://www.amazon.com/Floating-Locket-Lanyard-Holder-Interchangeable/dp/B01I47N76Y; Mar. 2, 2017.
 Kameleon Interchangeable Jewelry; https://kameleonjewelry.com/care-how-tos/product-faq. Feb. 8, 2017.
 Utility U.S. Appl. No. 15/602,559 entitled Jewelry Assembly with Removable Tile filed May 23, 2017.
 Design U.S. Appl. No. 29/627,090 entitled Jewelry Assembly with Removable Tile filed Nov. 22, 2017.
 Design U.S. Appl. No. 29/627,091 entitled Jewelry Assembly with Removable Tile filed Nov. 22, 2017.

* cited by examiner

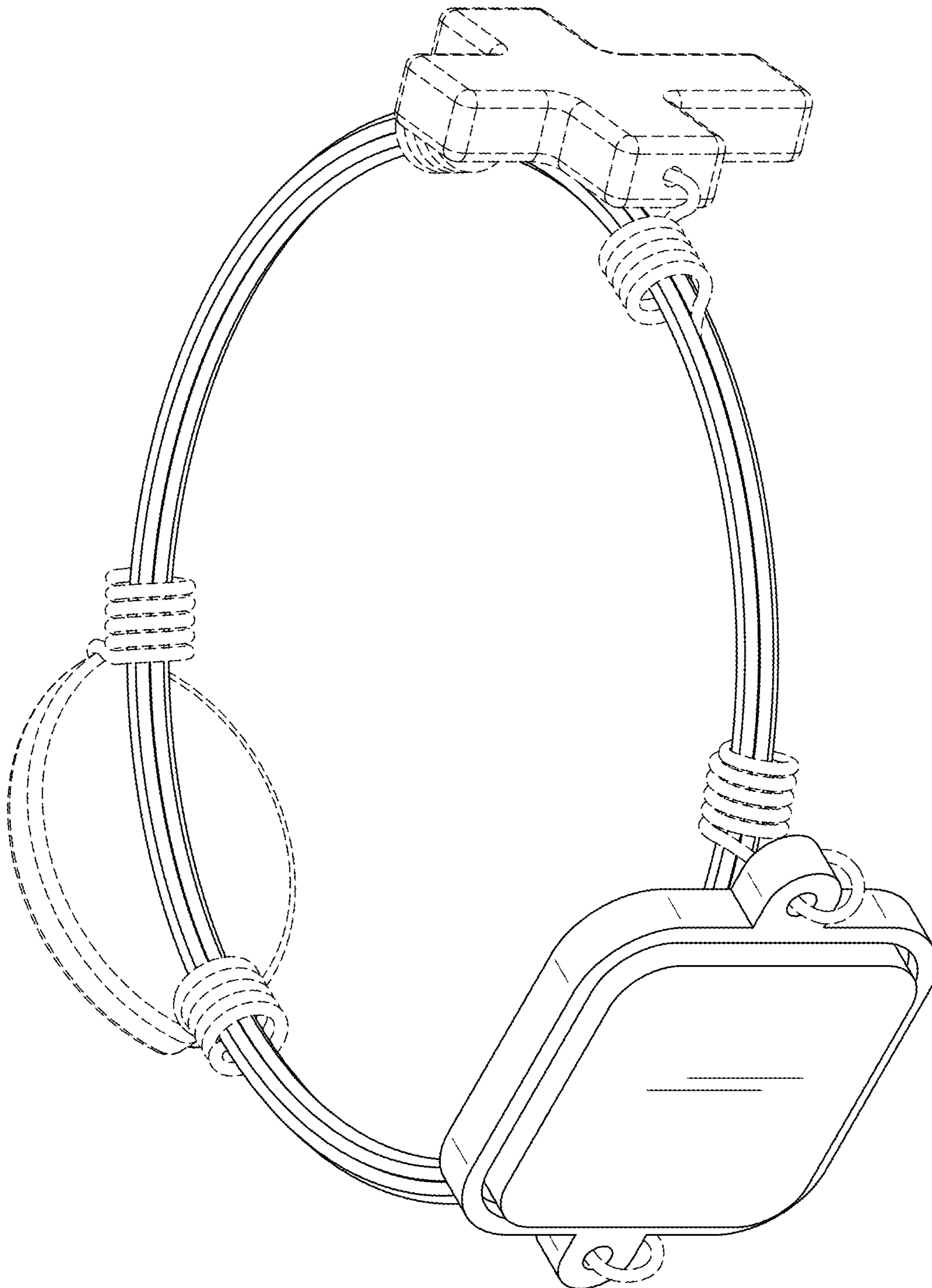

FIG. 1

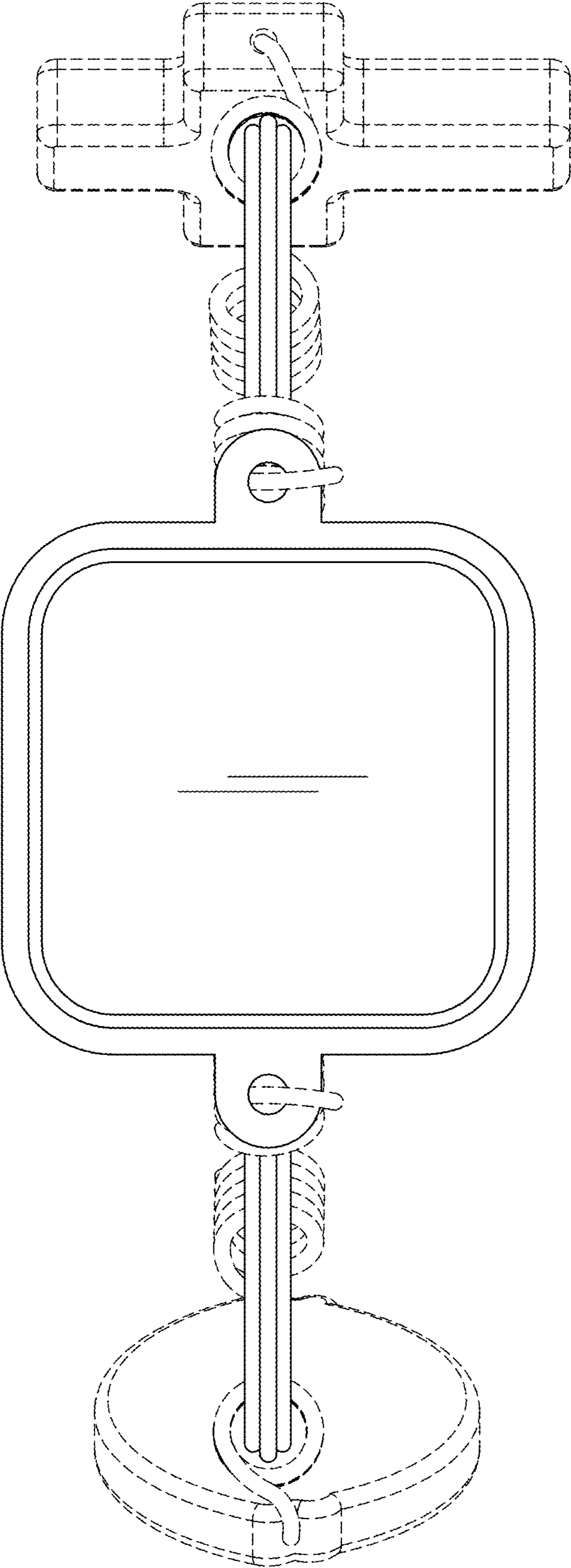

FIG. 2

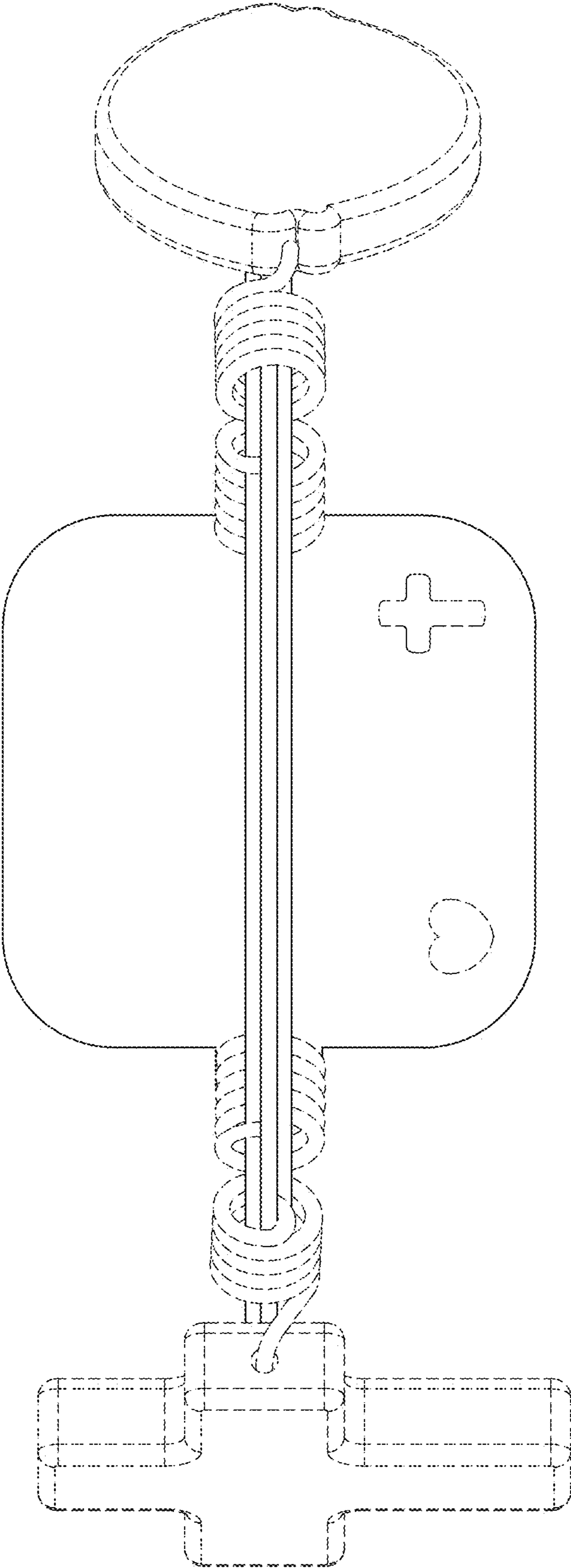

FIG. 3

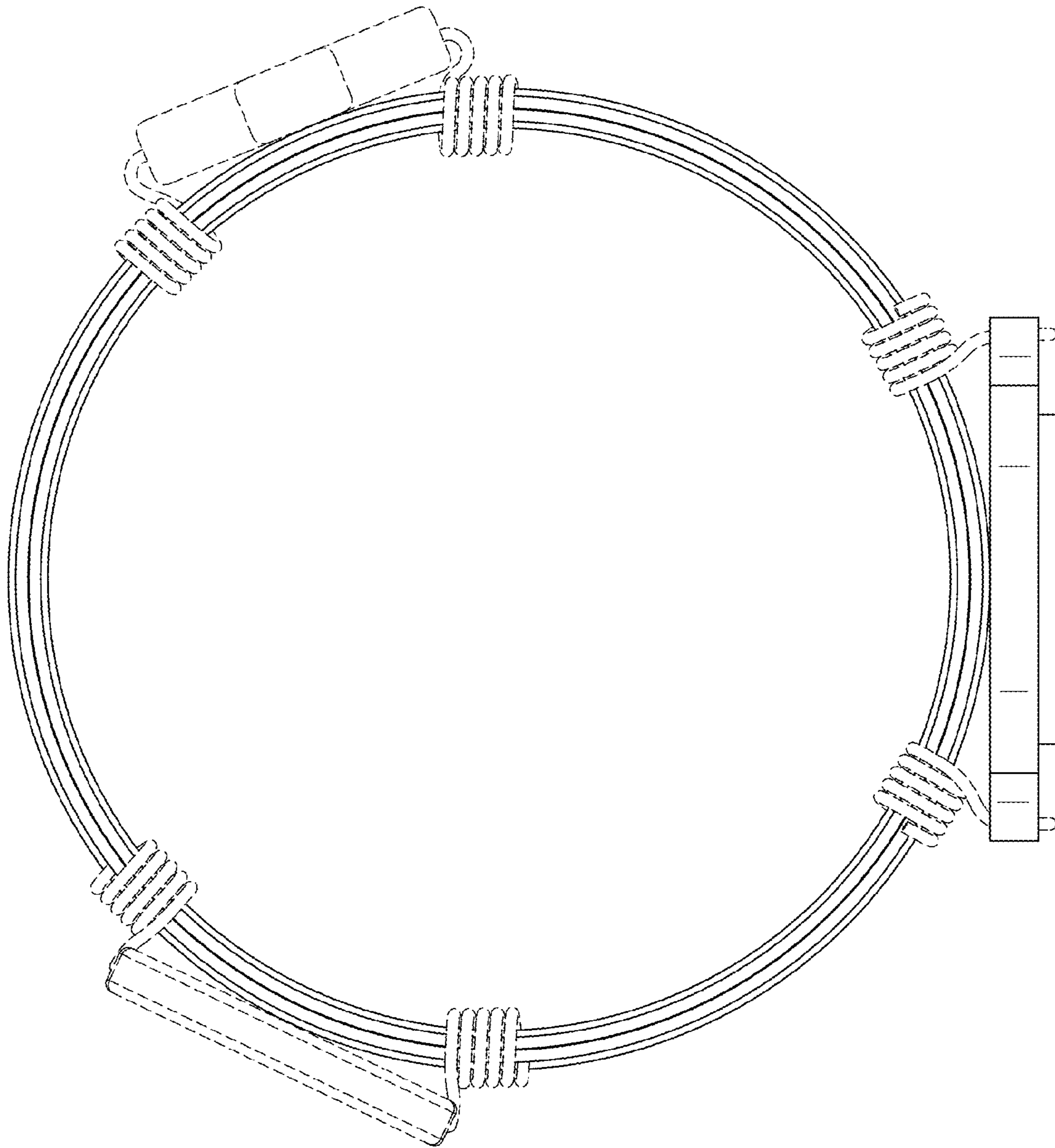

FIG. 4

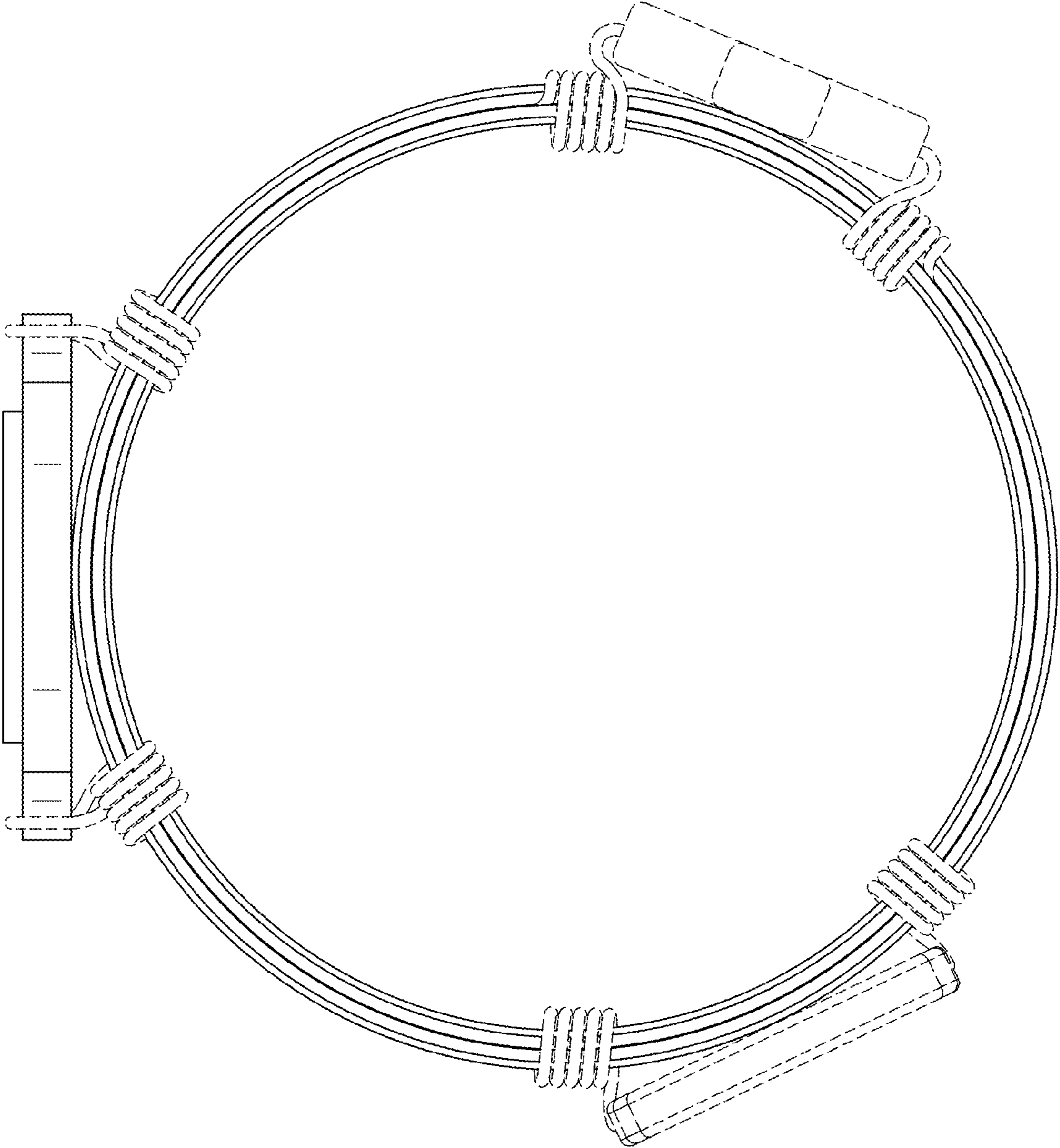

FIG. 5

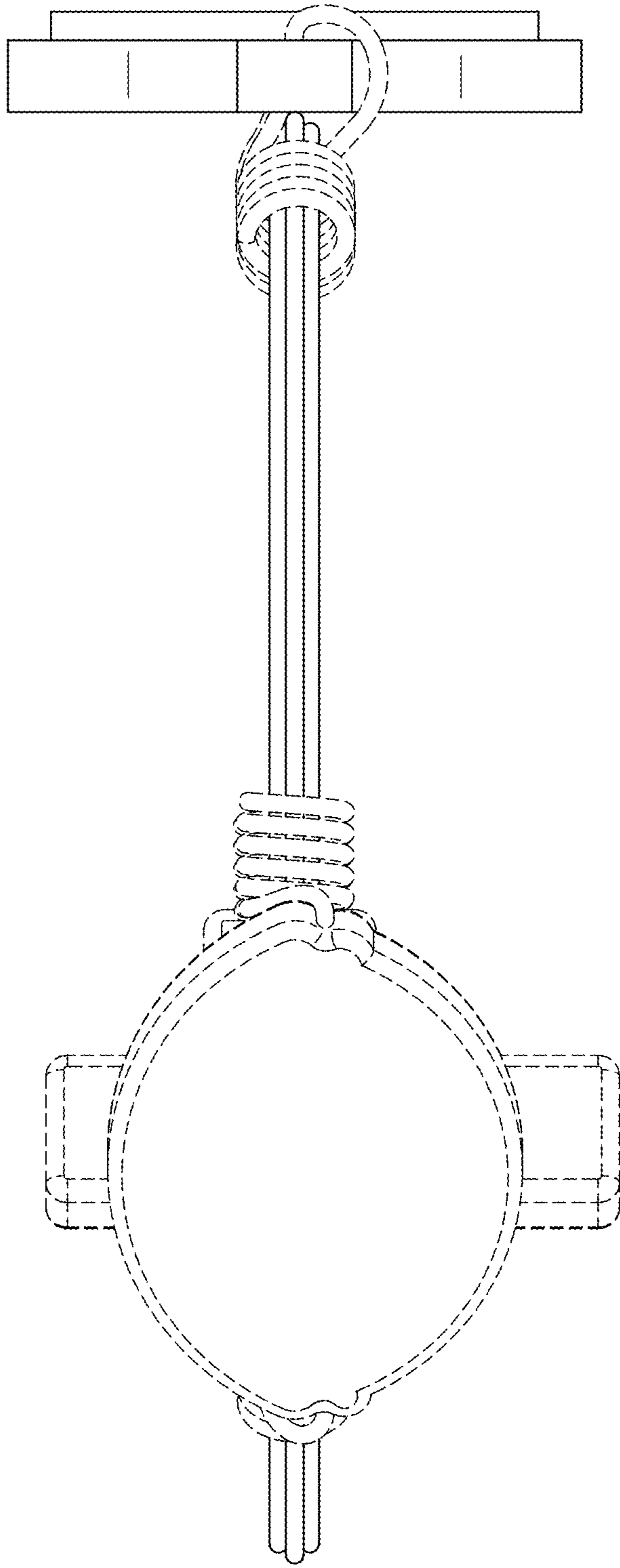

FIG. 6

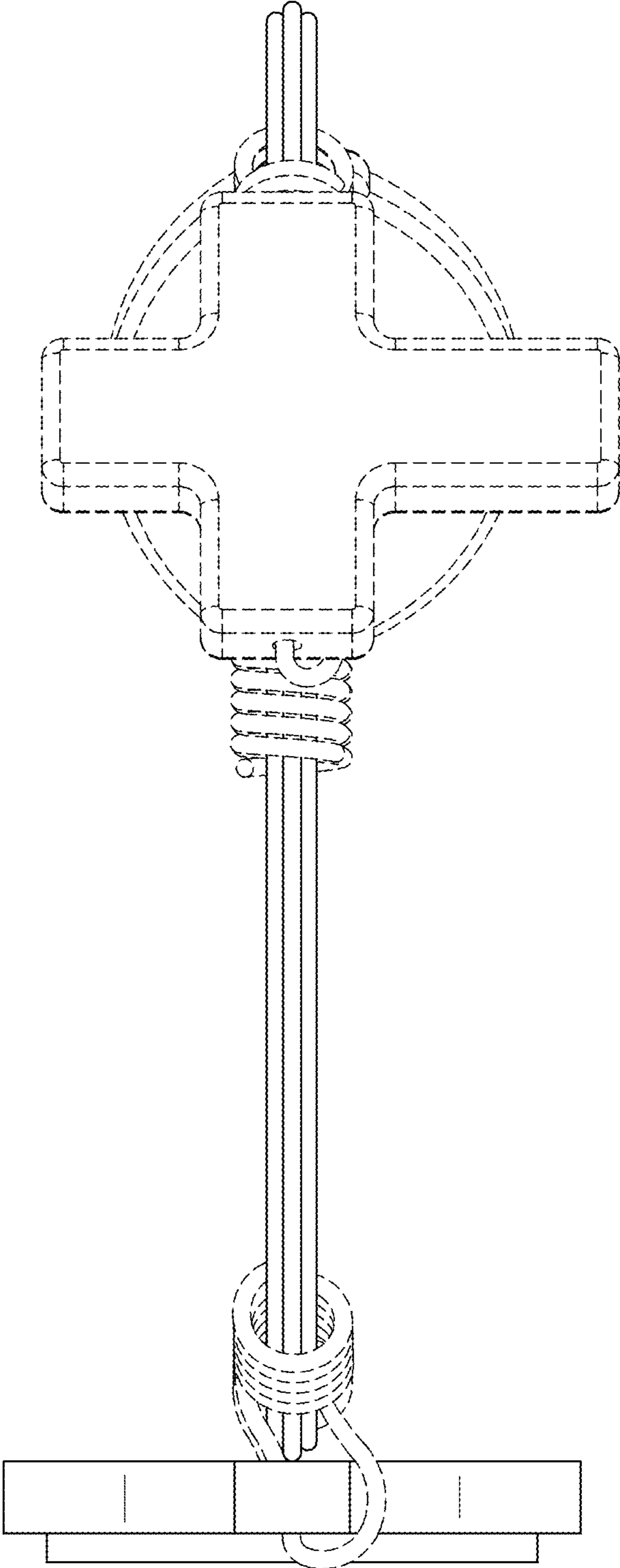

FIG. 7