



US00D874310S

(12) **United States Design Patent** (10) **Patent No.:** **US D874,310 S**
DiMartini et al. (45) **Date of Patent:** **** Feb. 4, 2020**

(54) **BRACELET FOR A WATCH**

(71) Applicants: **Michael J. DiMartini**, St. Louis, MO
(US); **Justin Kraudel**, St. Louis, MO
(US)

(72) Inventors: **Michael J. DiMartini**, St. Louis, MO
(US); **Justin Kraudel**, St. Louis, MO
(US)

(**) Term: **15 Years**

(21) Appl. No.: **29/641,338**

(22) Filed: **Mar. 21, 2018**

(51) **LOC (12) Cl.** **11-01**

(52) **U.S. Cl.**
USPC **D11/3**

(58) **Field of Classification Search**
USPC D11/1-7, 13-20, 26; D10/31, 32, 38, 70;
D14/344

CPC A44C 11/00; A44C 11/002; A44C 11/005;
A44C 11/007; A44C 5/00; A44C 5/02;
A44C 5/022; A44C 5/025; A44C 5/027;
A44C 5/04; A44C 5/06; A44C 5/08;
A44C 5/10; A44C 5/102; A44C 5/105;
A44C 5/107; A44C 5/14; A44C 5/142;
A44C 5/145; A44C 5/147; A44C 5/16;
A44C 5/0053; A44C 5/0061; A44C
5/0069; A44C 5/0076

See application file for complete search history.

(56) **References Cited**

U.S. PATENT DOCUMENTS

D313,940 S * 1/1991 Bonnet D10/32
D342,037 S * 12/1993 Giardiello D11/25
D356,749 S * 3/1995 Giardiello D11/3
D399,161 S * 10/1998 Mougnot D11/3
D405,711 S * 2/1999 Feuvrier D11/19
D417,411 S * 12/1999 Cattin D11/3
D443,833 S * 6/2001 Lepeu D10/32

D444,075 S * 6/2001 Lepeu D10/32
D445,055 S * 7/2001 Subilia D11/3
D471,126 S * 3/2003 Calvani D11/3
D471,482 S * 3/2003 Calvani D11/3
D473,154 S * 4/2003 Lepeu D11/3
D548,637 S * 8/2007 Scarinzi D10/32
D548,638 S * 8/2007 Chodat D10/32
D658,509 S * 5/2012 Wai Kei D10/32
D701,778 S * 4/2014 Duport D10/32
D719,850 S * 12/2014 Kita D10/32
D729,075 S * 5/2015 Delhotal D10/32
D735,060 S * 7/2015 Monachon D10/32
D735,069 S * 7/2015 Paradise D11/3

(Continued)

OTHER PUBLICATIONS

Monta Company's Facebook Photos, online, published on Sep. 9, 2016. Site visited Dec. 26, 2018. Internet URL: <"https://www.facebook.com/montawatch/photos/a.1703065123266232/1762349440671133/?type=3&theater"> (Year: 2016).*

(Continued)

Primary Examiner — L. Martinez

(74) *Attorney, Agent, or Firm* — Charles McCloskey

(57) **CLAIM**

The ornamental design for a bracelet for a watch, as shown and described.

DESCRIPTION

FIG. 1 is a top view of a bracelet for a watch showing our new design;

FIG. 2 is a side view thereof;

FIG. 3 is a bottom view thereof;

FIG. 4 is a side view thereof;

FIG. 5 is a front view thereof;

FIG. 6 is a back view thereof; and,

FIG. 7 is a top perspective view thereof.

The broken line areas show portions of the bracelet for a watch that form no part of the claimed design.

1 Claim, 2 Drawing Sheets

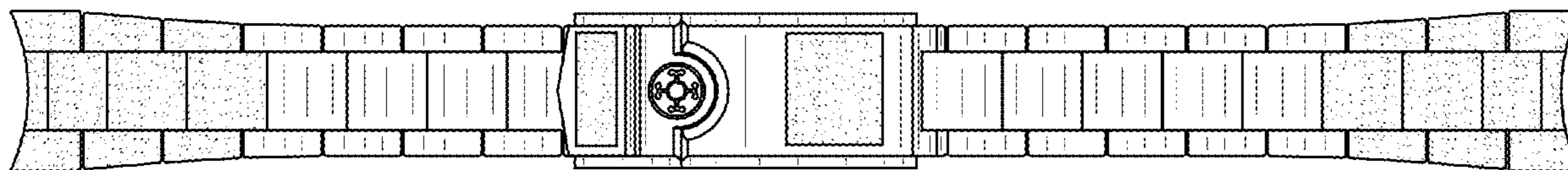

(56)

References Cited

U.S. PATENT DOCUMENTS

D739,289	S *	9/2015	Cerrato	D11/3
D758,889	S *	6/2016	Cerrato	D10/30
D760,603	S *	7/2016	Soares	D10/32
D760,604	S *	7/2016	Duport	D10/32
D761,130	S *	7/2016	Soares	D10/32
D767,437	S *	9/2016	Rabassa	D11/12
D769,764	S *	10/2016	Mille	D11/3
9,693,608	B1 *	7/2017	Rota	A44C 5/107
2012/0069720	A1 *	3/2012	Catheline	A44C 5/107 63/9
2013/0152542	A1 *	6/2013	Kaltenrieder	A44C 5/185 59/82
2016/0316865	A1 *	11/2016	Berg	A44C 5/107
2018/0107168	A1 *	4/2018	Han	A44C 5/0061
2018/0168293	A1 *	6/2018	Leiggener	A44C 5/0061

OTHER PUBLICATIONS

Monta Company's Facebook Photos, online, published on Sep. 28, 2016. Site visited Dec. 26, 2018. Internet URL:<"https://www.facebook.com/montawatch/photos/a.1703065123266232/1770346216538122/?type=3&theater"> (Year: 2016).*

Monta Company's Facebook Photos, online, published on Jun. 6, 2017. Site visited Dec. 26, 2018. Internet URL:"https://www.facebook.com/montawatch/photos/a.1703065123266232/1886210098285066/?type=3&theater"> (Year: 2017).*

* cited by examiner

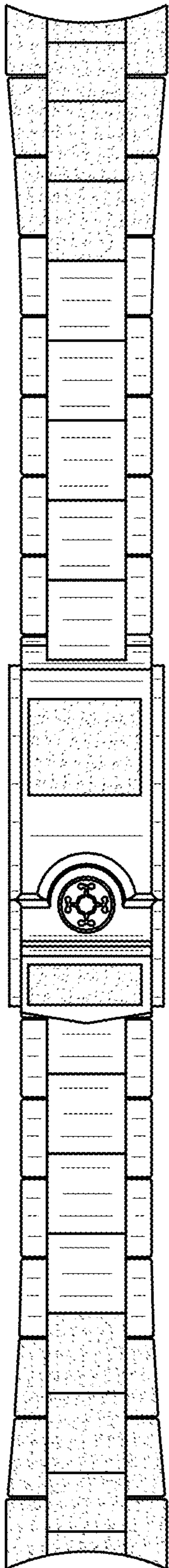

FIG. 1

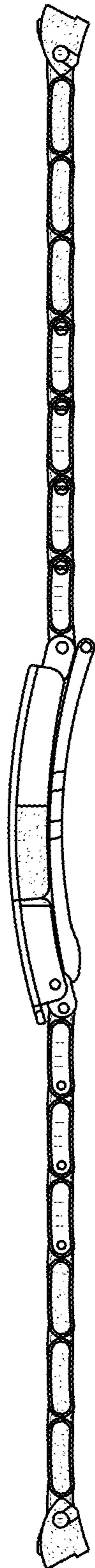

FIG. 2

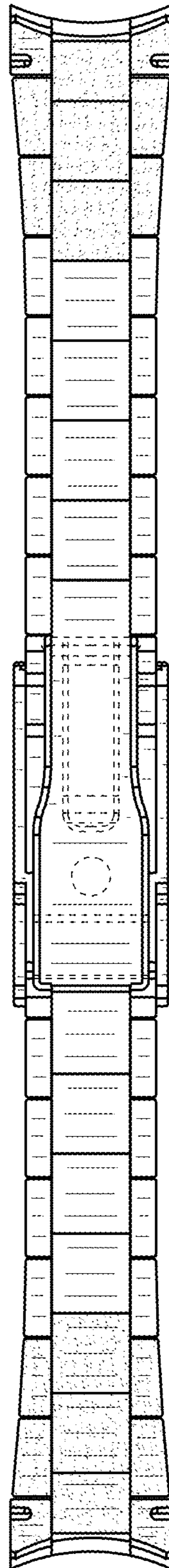

FIG. 3

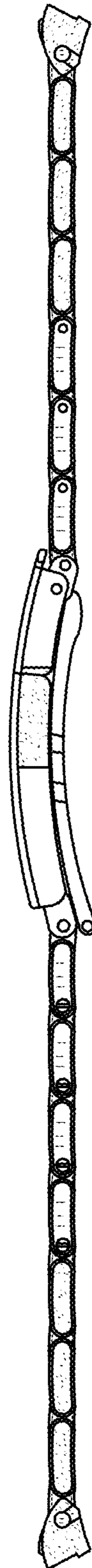

FIG. 4

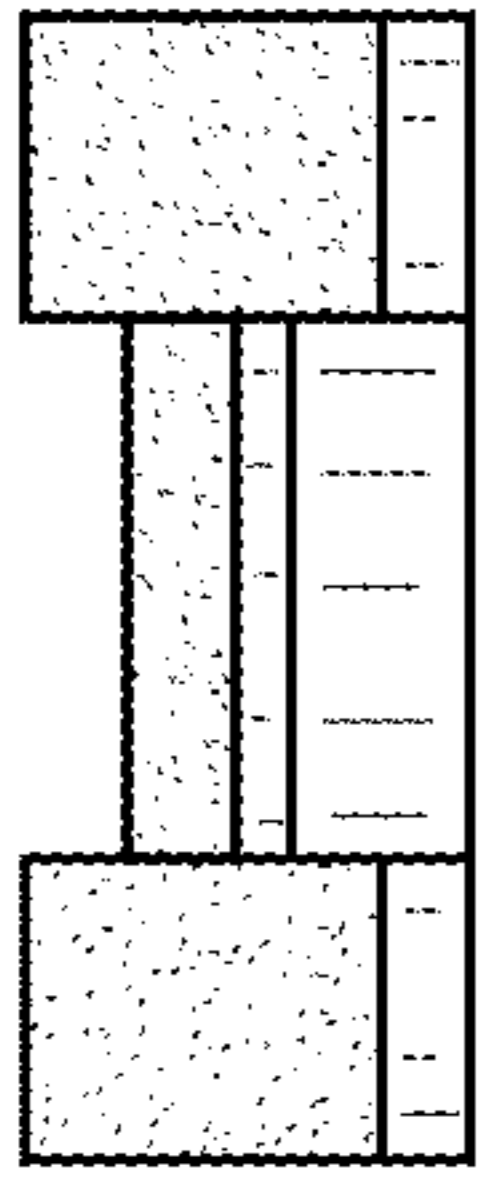

FIG. 5

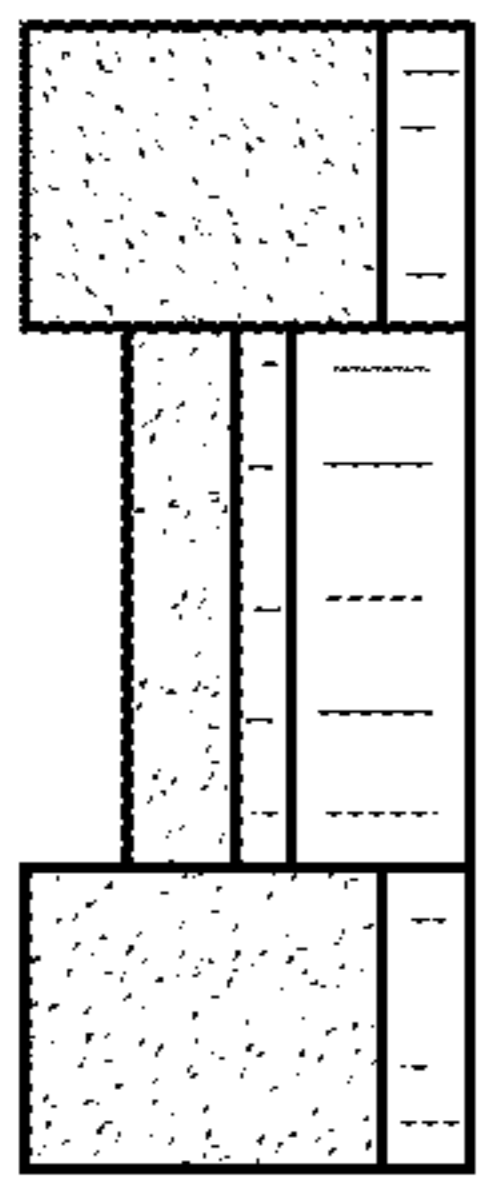

FIG. 6

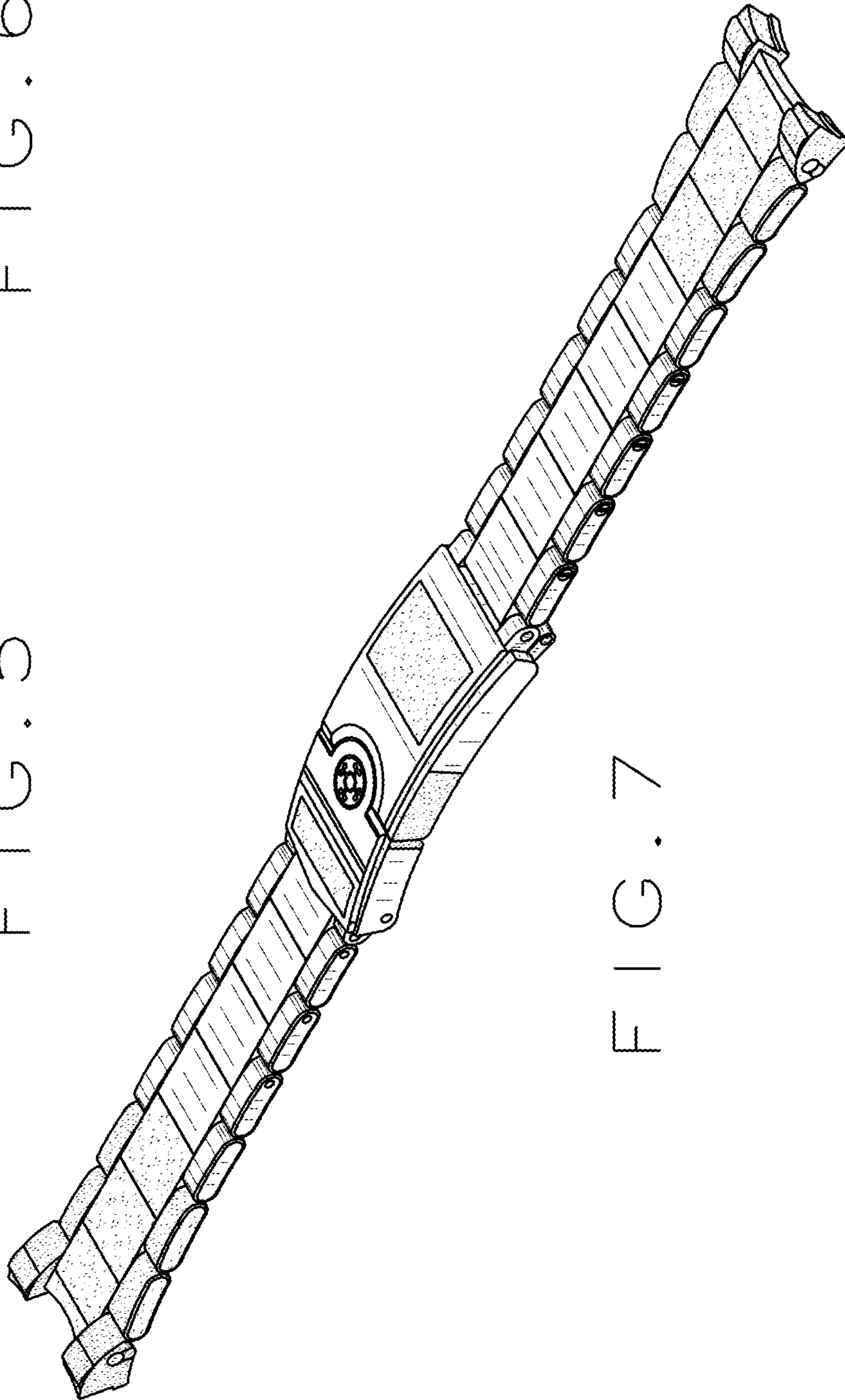

FIG. 7