



US00D874308S

(12) **United States Design Patent** (10) **Patent No.:** **US D874,308 S**
Charrier (45) **Date of Patent:** **** Feb. 4, 2020**

(54) **WATCH DIAL**

FOREIGN PATENT DOCUMENTS

(71) Applicant: **Richemont International SA,**
Villars-sur-Glane (CH)

CN 201530547918.3 * 12/2015

(72) Inventor: **Bastien Charrier,** Vulbens (FR)

OTHER PUBLICATIONS

(73) Assignee: **Richemont International SA,**
Villars-sur-Glane (CH)

Amazon, Tommy Hilfiger Watch, posted May 19, 2017, [online], [visited Sep. 5, 2019]. Internet, URL: https://www.amazon.co.uk/Tommy-Hilfiger-Womens-Watch-1781795/dp/B0728GQ6CF/ref=olp_product_details?_encoding=UTF8&me= (Year: 2017).*
Amazon, Michael Kors Women's Watch, posted Oct. 10, 2017, [online], [visited Sep. 5, 2019]. Internet, URL: https://www.amazon.co.uk/Michael-Kors-Analogue-Stainless-MK3794/dp/B076751B2X/ref=olp_product_details?_encoding=UTF8&me= (Year: 2017).*
Arabian Knight, Excalibur raises the bar, posted Jan. 12, 2015, [online], [visited Sep. 6, 2019]. Internet, URL: <http://www.arabianknightonline.com/Details/315/Excalibur-raises-the-bar> (Year: 2015).*

(**) Term: **15 Years**

(21) Appl. No.: **29/656,422**

(22) Filed: **Jul. 12, 2018**

(30) **Foreign Application Priority Data**

Jan. 15, 2018 (WO) DM/100725

* cited by examiner

(51) **LOC (12) Cl.** **10-07**

Primary Examiner — Sheryl Lane

(52) **U.S. Cl.**

Assistant Examiner — Samantha N Wood

USPC **D10/126**

(74) *Attorney, Agent, or Firm* — Taft Stettinius &

(58) **Field of Classification Search**

Hollister LLP

USPC D10/1, 6, 7, 8, 30, 31, 32, 37, 38, 39,
D10/122, 123, 124, 125, 126, 132, 128

(57) **CLAIM**

CPC G04B 1/00; G04B 19/00; G04B 19/02;
G04B 19/046; G04B 19/06; G04B
19/065; G04B 19/08; G04B 19/085;
G04B 19/18; G04B 19/12; G04B 19/20;
G04B 19/202; G04B 19/24; G04B 19/166

The ornamental design for a watch dial, as shown and described.

See application file for complete search history.

DESCRIPTION

(56) **References Cited**

U.S. PATENT DOCUMENTS

D592,986 S * 5/2009 Nataf D10/128
D624,440 S * 9/2010 Wunderman D10/32
D710,729 S * 8/2014 Delhotal D10/124
D795,119 S * 8/2017 Kamilindi D10/126
D830,216 S * 10/2018 Gurtner D10/126

FIG. 1 is a front elevational view of a watch dial showing my new design;
FIG. 2 is a back elevational view thereof;
FIG. 3 is a right side elevational view thereof;
FIG. 4 is a left side elevational view thereof;
FIG. 5 is a top plan view thereof;
FIG. 6 is a bottom plan view thereof;
FIG. 7 is a front, right side perspective view thereof; and,
FIG. 8 is a back, left side perspective view thereof.

1 Claim, 8 Drawing Sheets

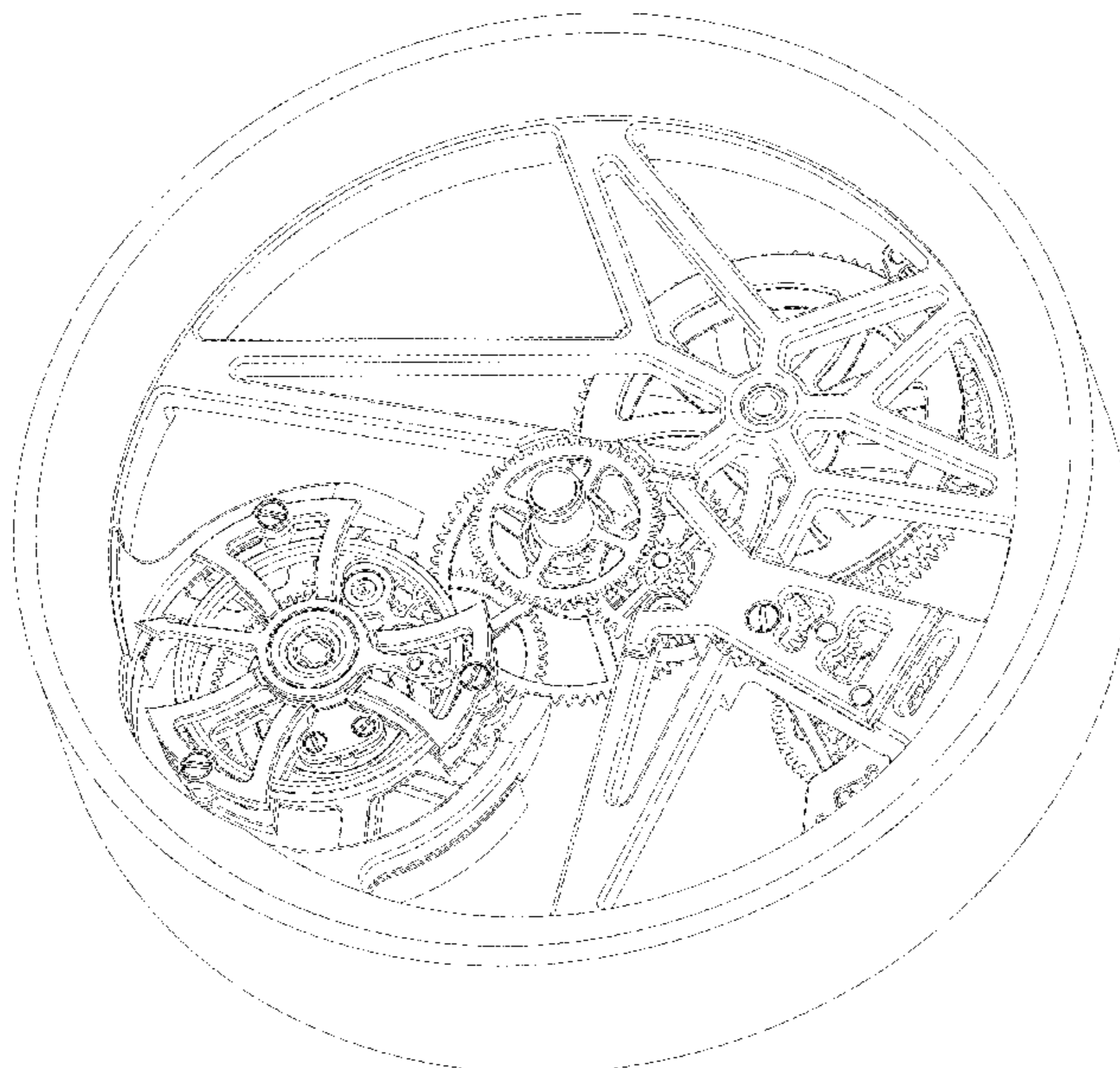

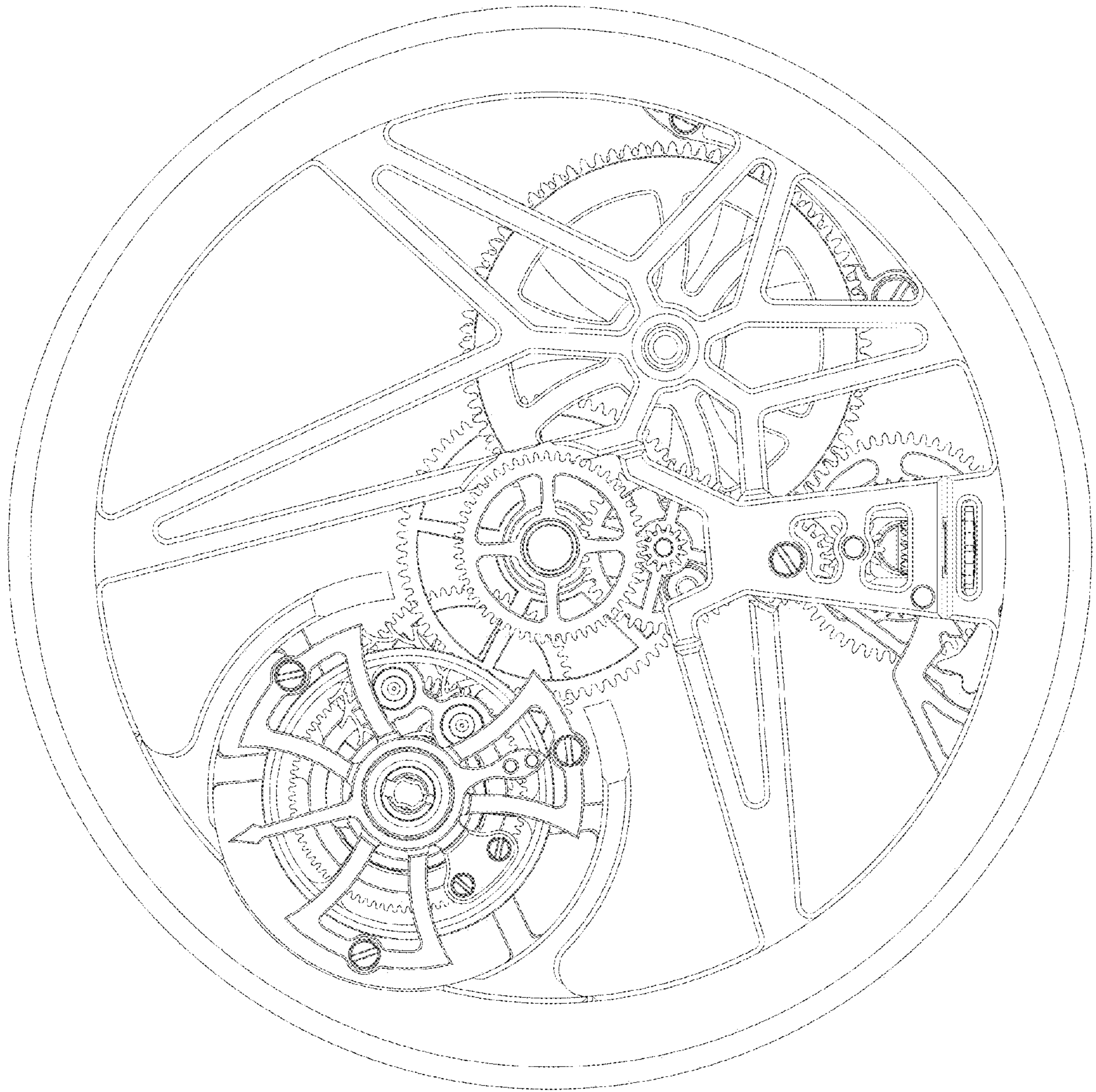

Fig. 1

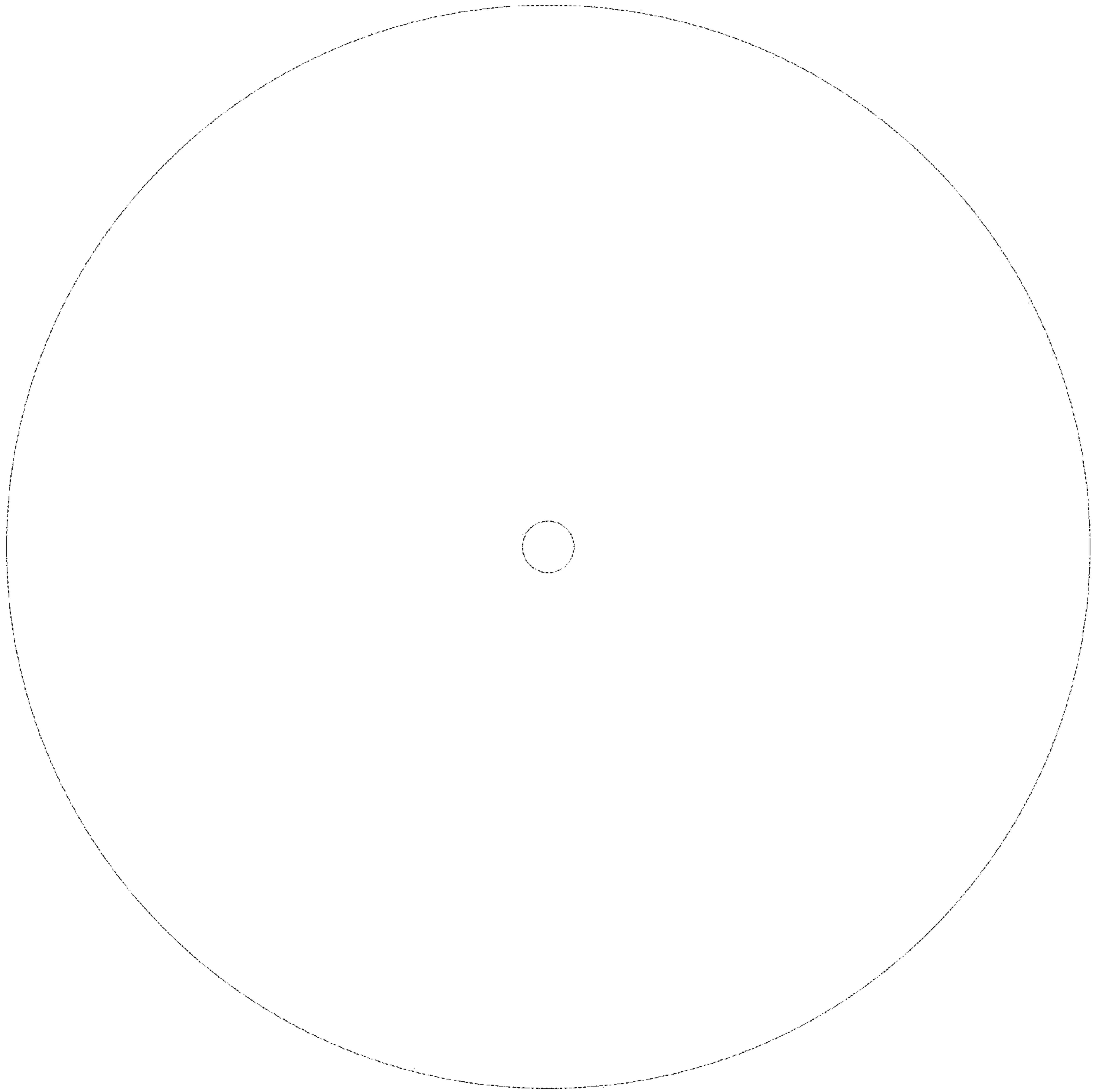

Fig. 2

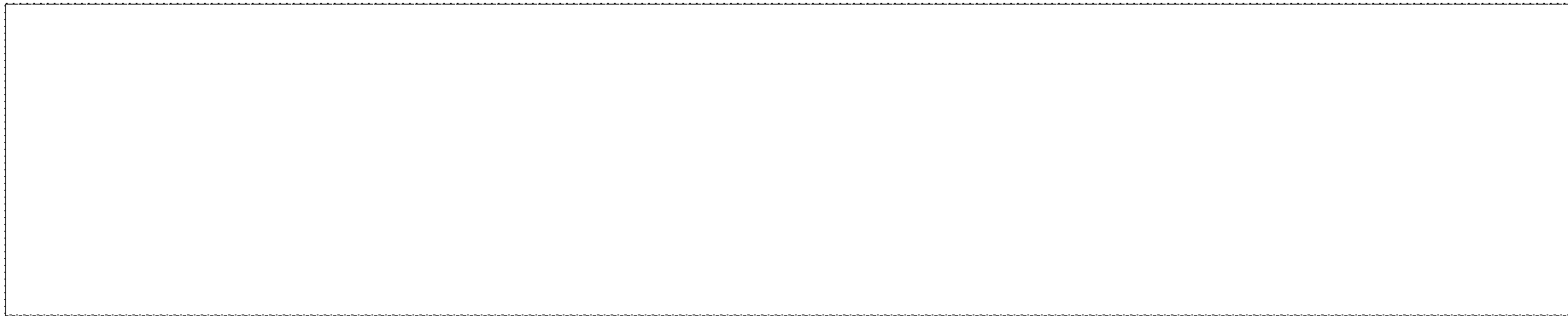

Fig. 3



Fig. 4

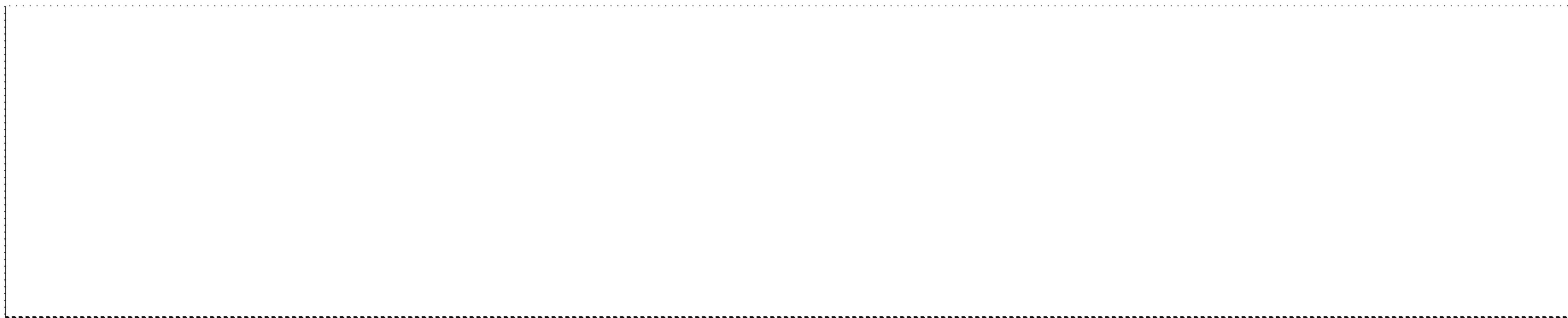

Fig. 5



Fig. 6

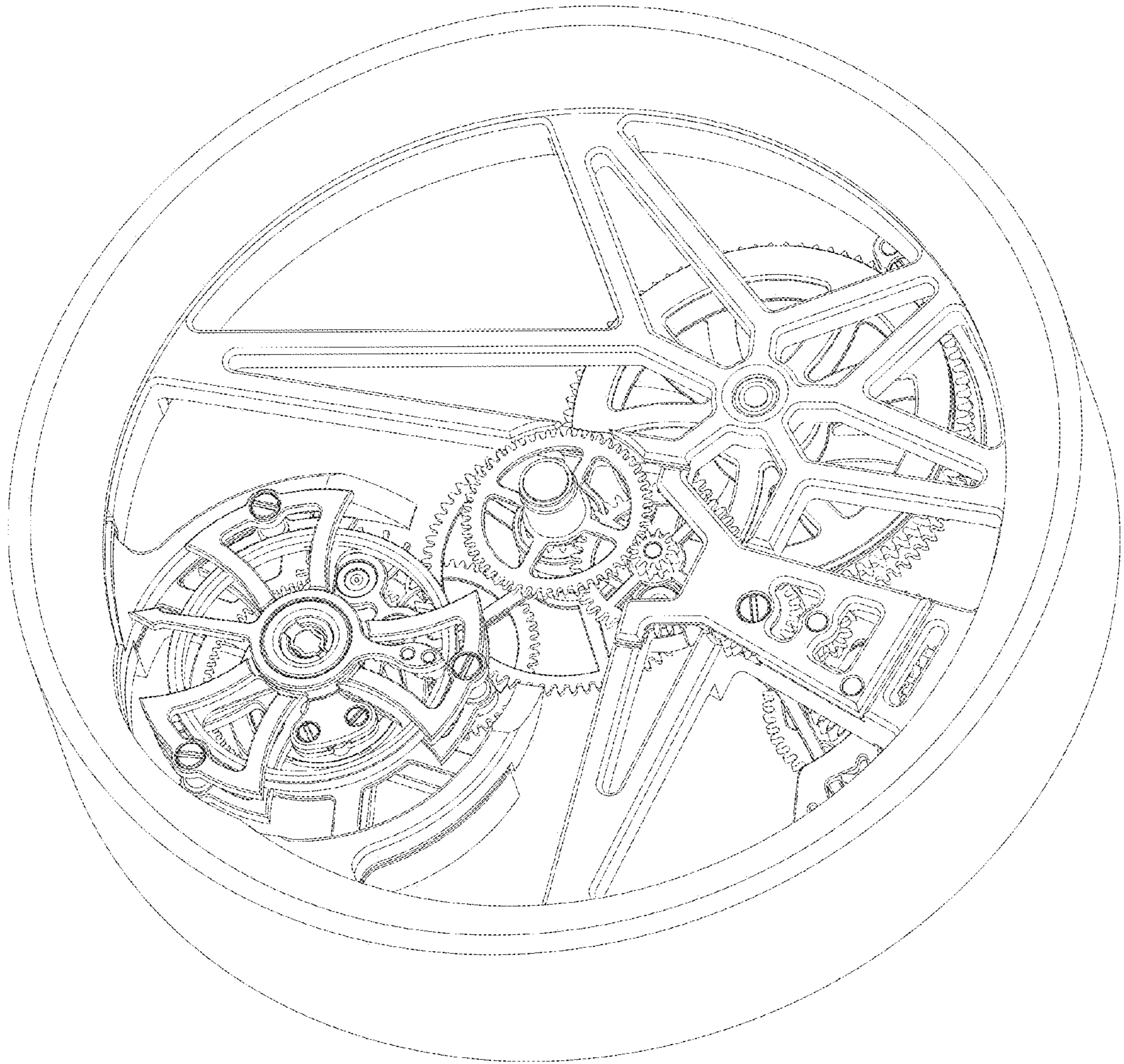

Fig. 7

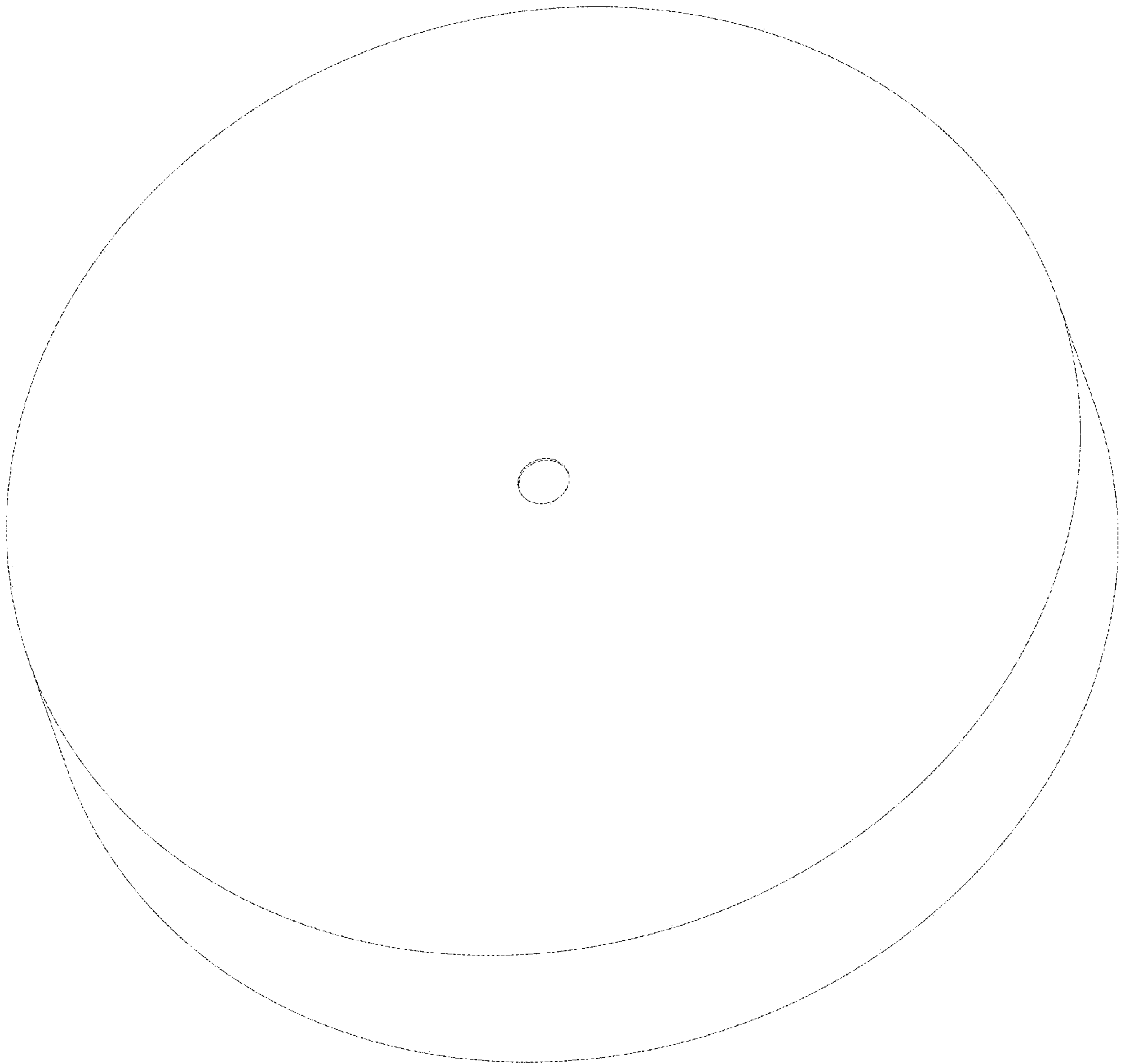

Fig. 8