



US00D874283S

(12) **United States Design Patent** (10) **Patent No.:** **US D874,283 S**  
**Cartis et al.** (45) **Date of Patent:** **\*\* Feb. 4, 2020**

(54) **BOTTLE**

(71) Applicant: **PepsiCo, Inc.**, Purchase, NY (US)  
(72) Inventors: **Emilian Dan Cartis**, London (GB);  
**Ryan Campbell**, New York, NY (US);  
**Niklas Gustafsson**, New York, NY  
(US); **Meatta T. Kemokai**, Stamford,  
CT (US); **Kamal Mahajan**, Tarrytown,  
NY (US); **Syed Peer**, Arlington  
Heights, IL (US); **Bruno Telesca**,  
Sandy Hook, CT (US); **Koby Hebborn**  
**Trout**, Brooklyn, NY (US); **Moreno**  
**Barel**, Refrontolo (IT)

(73) Assignee: **PepsiCo, Inc.**, Purchase, NY (US)

(\*\*) Term: **15 Years**

(21) Appl. No.: **29/684,223**

(22) Filed: **Mar. 19, 2019**

**Related U.S. Application Data**

(63) Continuation of application No. 29/613,645, filed on  
Aug. 11, 2017, now Pat. No. Des. 844,437.

(51) **LOC (12) Cl.** ..... **09-01**

(52) **U.S. Cl.**  
USPC ..... **D9/503; D9/505; D9/542**

(58) **Field of Classification Search**  
USPC ..... D7/300–322, 391–396.2, 509–511, 523,  
D7/589, 598, 612, 615, 619.1; D9/435,  
D9/436, 439, 440, 443, 447, 454, 500,  
D9/503–505, 516–575, 763–783;  
215/40–55, 316–354, 370–385;  
220/574–575  
CPC ..... B65D 1/00; B65D 1/02; B65D 1/0223;  
B65D 1/023; B65D 1/0276

See application file for complete search history.

(56) **References Cited**

U.S. PATENT DOCUMENTS

D78,628 S	5/1929	Kart
D81,520 S	7/1930	Bromiley
D197,919 S	4/1964	Runyon
3,446,382 A	5/1969	Koll et al.
D219,125 S	11/1970	Gortz et al.
D281,584 S	12/1985	Berglund
4,586,863 A	5/1986	Morimoto et al.
D295,259 S	4/1988	Goettner
D295,260 S	4/1988	Goettner
4,768,667 A	9/1988	Magnusson
D308,828 S	6/1990	Magnusson

(Continued)

OTHER PUBLICATIONS

Idea, No. 6, vol. 37, p. 89 (Nov. 1, 1989).

(Continued)

*Primary Examiner* — Cathron C Brooks

*Assistant Examiner* — Christian P. McLean

(74) *Attorney, Agent, or Firm* — Sterne, Kessler,  
Goldstein & Fox P.L.L.C.

(57) **CLAIM**

The ornamental design for a bottle, as shown and described.

**DESCRIPTION**

FIG. 1 is a top front perspective view of a bottle showing the  
claimed design;

FIG. 2 is a bottom rear perspective view thereof;

FIG. 3 is a front view thereof;

FIG. 4 is a rear view thereof;

FIG. 5 is a left side view thereof;

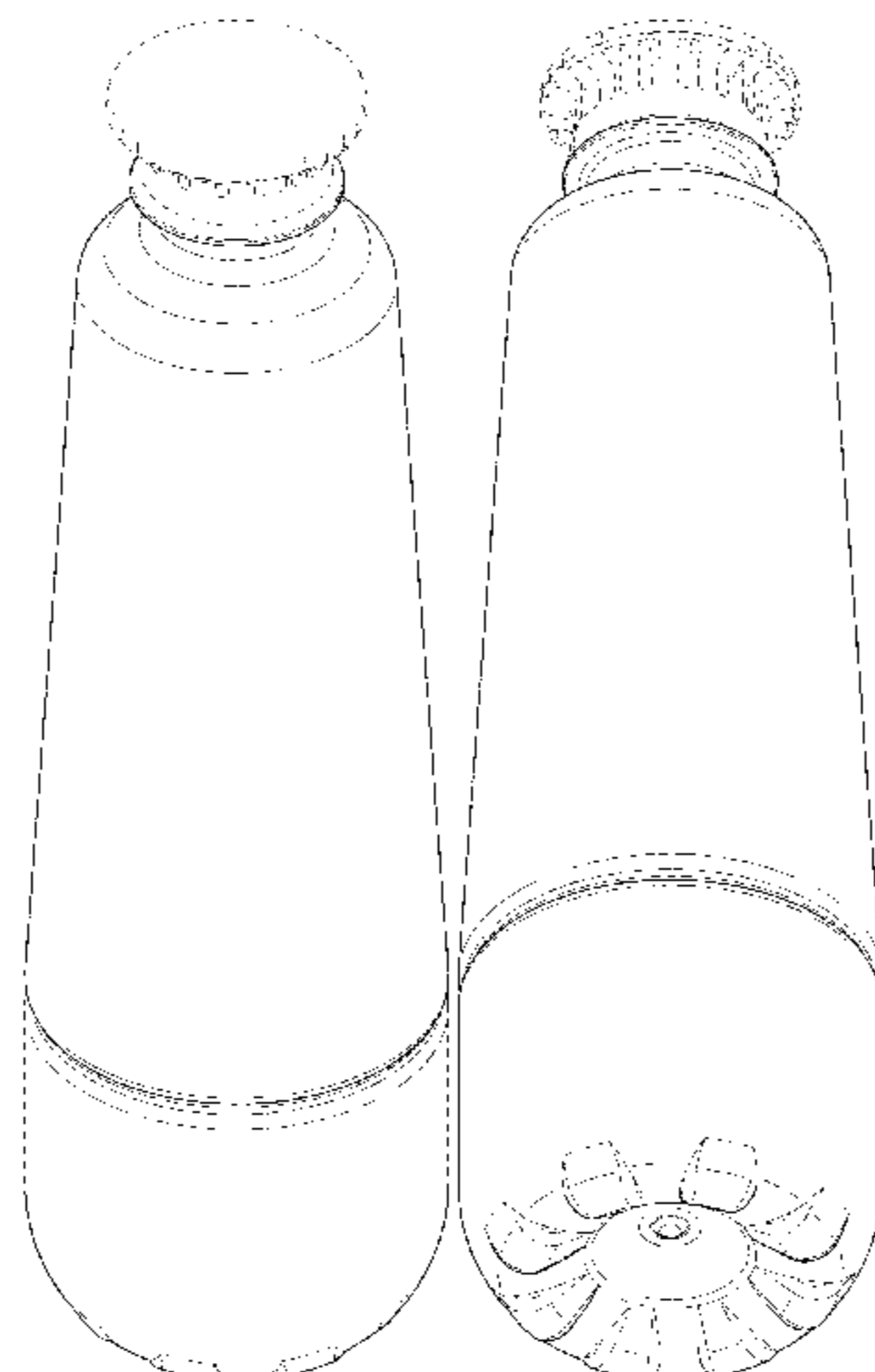
FIG. 6 is a right side view thereof;

FIG. 7 is a top view thereof; and,

FIG. 8 is a bottom view thereof.

The broken lines in the figures show portions of the bottle  
that form no part of the claimed design.

**1 Claim, 7 Drawing Sheets**



(56)

References Cited

U.S. PATENT DOCUMENTS

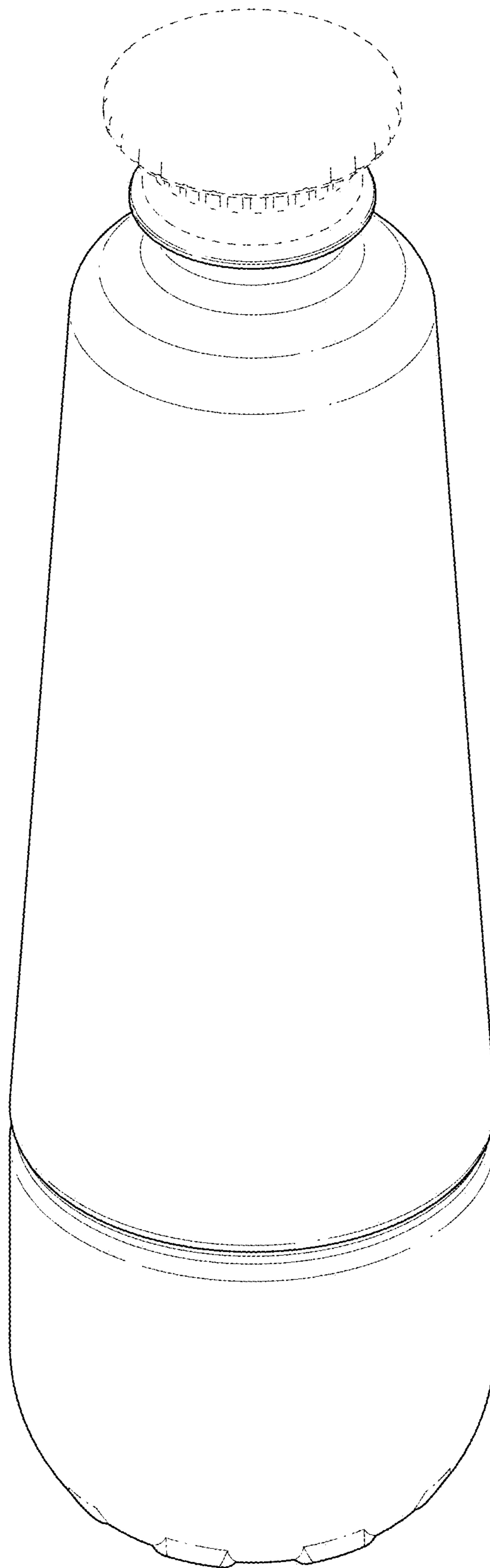
D329,803 S 9/1992 Otsuka  
 D403,592 S 1/1999 Everard et al.  
 D573,023 S 7/2008 Pivert  
 D576,044 S 9/2008 Lamb et al.  
 D596,942 S 7/2009 Britto  
 D608,204 S 1/2010 Caroan et al.  
 D616,754 S 6/2010 Arnell et al.  
 D623,475 S 9/2010 Aarnoudse et al.  
 D634,205 S 3/2011 Arnell et al.  
 D642,067 S 7/2011 Azar  
 D652,319 S 1/2012 Cohen et al.  
 D660,704 S \* 5/2012 Simmons ..... D9/449  
 D663,618 S 7/2012 Cohen et al.  
 D671,409 S 11/2012 Cohen et al.  
 D675,527 S 2/2013 Rogers et al.  
 D695,616 S 12/2013 Li  
 D696,130 S 12/2013 Zabari  
 D714,155 S 9/2014 Tanaka et al.  
 D745,398 S 12/2015 Cotton  
 D752,391 S 3/2016 Hatherell  
 D758,206 S \* 6/2016 Hoeke ..... D9/500  
 D772,070 S 11/2016 Broen et al.  
 D779,881 S 2/2017 Lee et al.  
 D784,144 S 4/2017 Cheng et al.  
 D784,768 S 4/2017 Lee et al.  
 D786,684 S 5/2017 McGreevy et al.

D812,480 S 3/2018 Newson  
 D817,095 S 5/2018 Kauss et al.  
 D817,096 S \* 5/2018 Kauss ..... D7/511  
 D819,403 S 6/2018 Li et al.  
 D821,150 S 6/2018 Liao  
 D821,200 S \* 6/2018 Harris ..... D9/500  
 D821,201 S 6/2018 Harris et al.  
 D821,205 S 6/2018 Christianson et al.  
 D830,773 S 10/2018 Jacobsen  
 D831,482 S \* 10/2018 Meyers ..... D9/447  
 D831,494 S 10/2018 Smith et al.  
 D832,651 S \* 11/2018 Wiet ..... D7/511  
 D834,420 S \* 11/2018 Harris ..... D9/500  
 D844,437 S \* 4/2019 Cartis ..... D9/558  
 D856,082 S \* 8/2019 Yao ..... D7/507  
 D858,198 S \* 9/2019 Hsu ..... D7/511  
 D858,288 S \* 9/2019 Prater ..... D9/516  
 D859,921 S \* 9/2019 Schmidt ..... D7/511  
 D860,793 S \* 9/2019 Cartis ..... D9/503  
 D864,722 S \* 10/2019 Kauffman ..... D9/504

OTHER PUBLICATIONS

Goldsmith, Justin. "Twist to Active Better Health: Activate Drinks." thedigestonline.com. Aug. 7, 2013. Accessed Jul. 18, 2018. Available online at URL: <<https://thedigestonline.com/lifestyle/twist-to-activate-better-health/>> (Year: 2013).

\* cited by examiner



**FIG. 1**

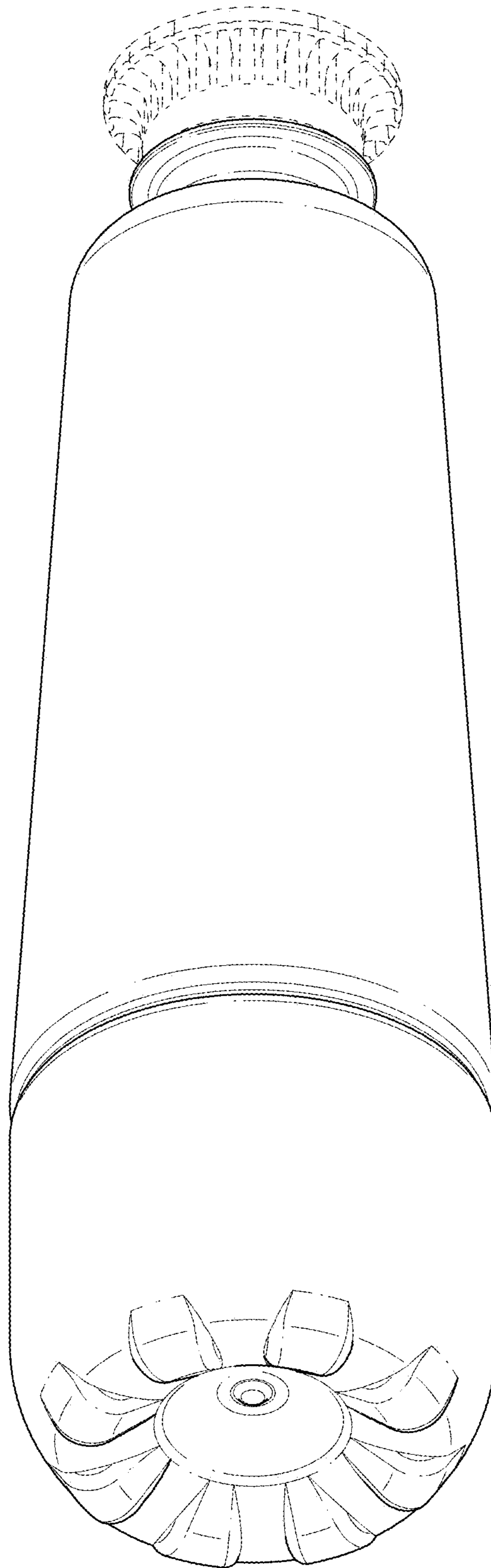
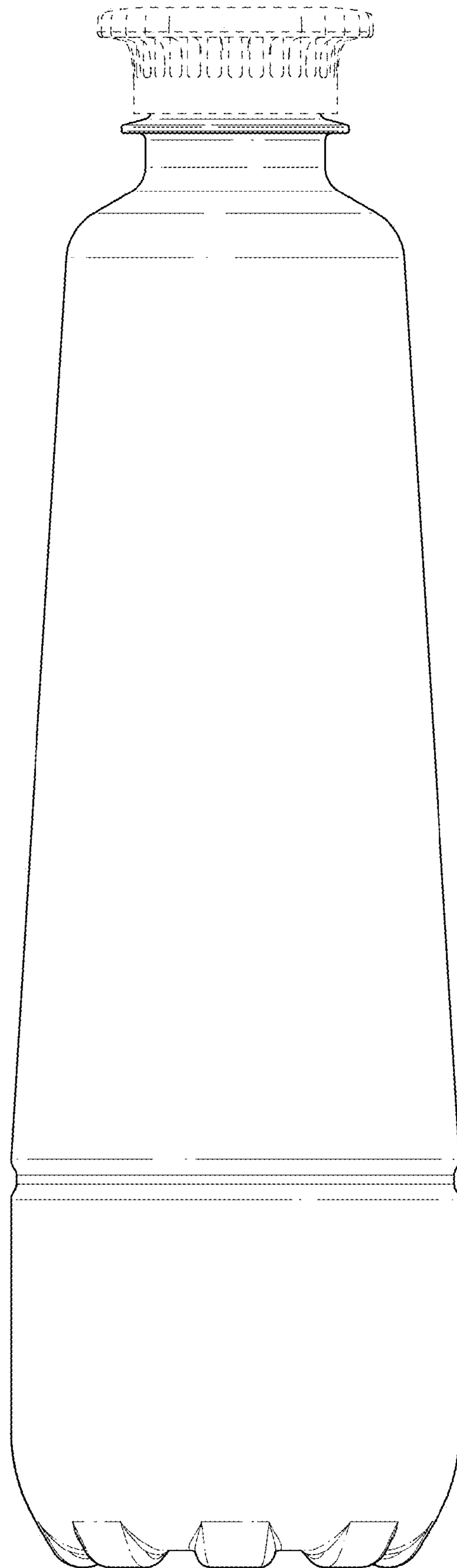
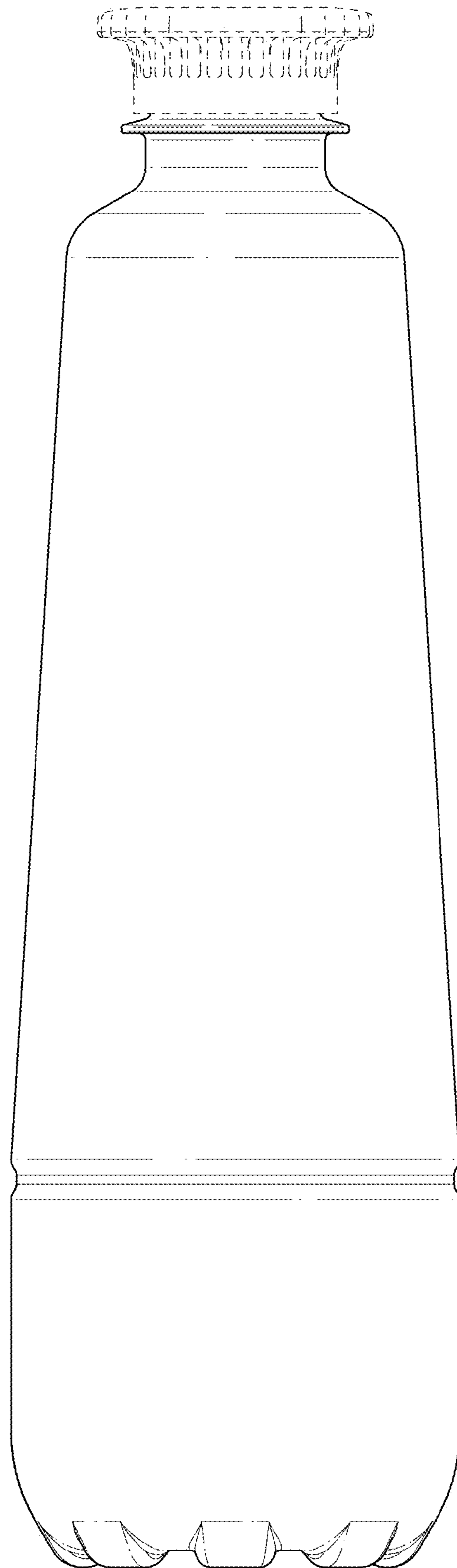


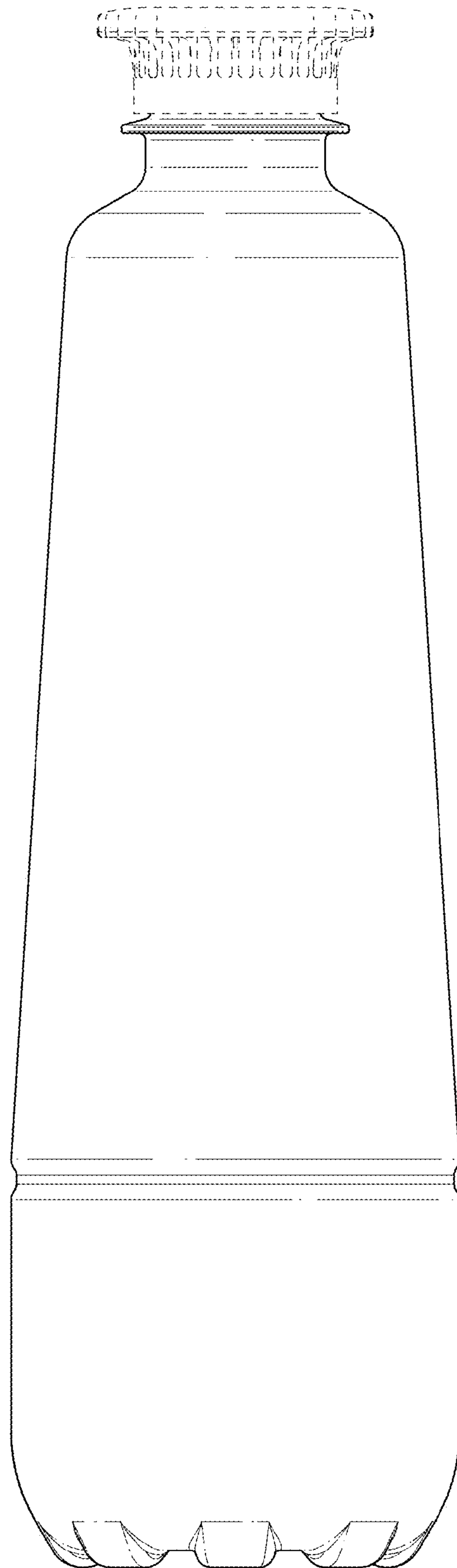
FIG. 2



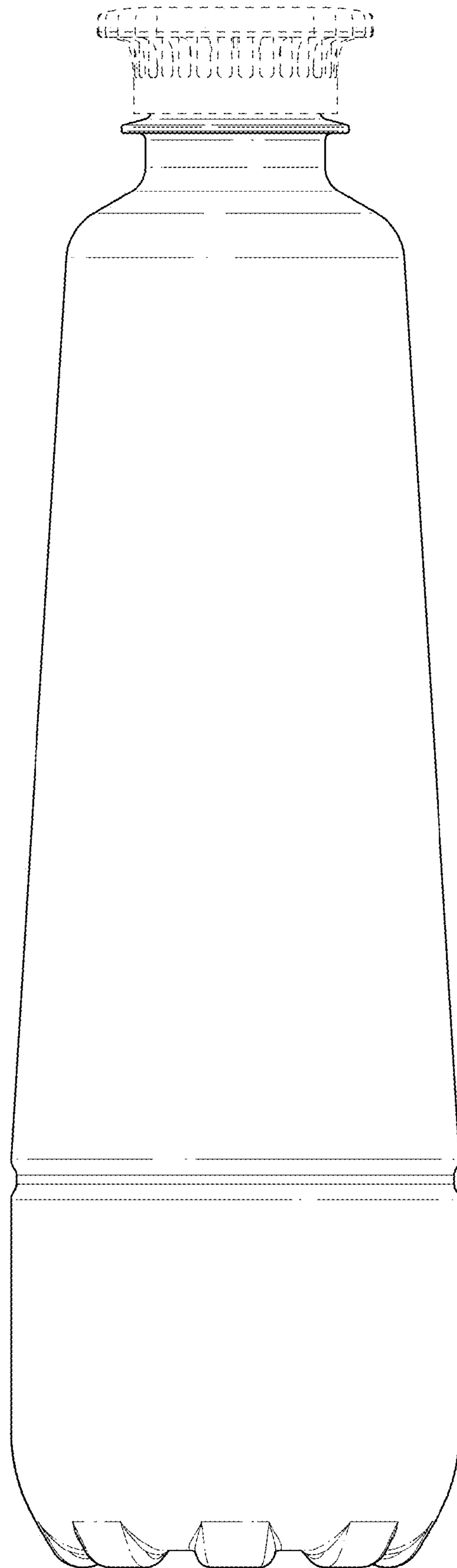
**FIG. 3**



**FIG. 4**

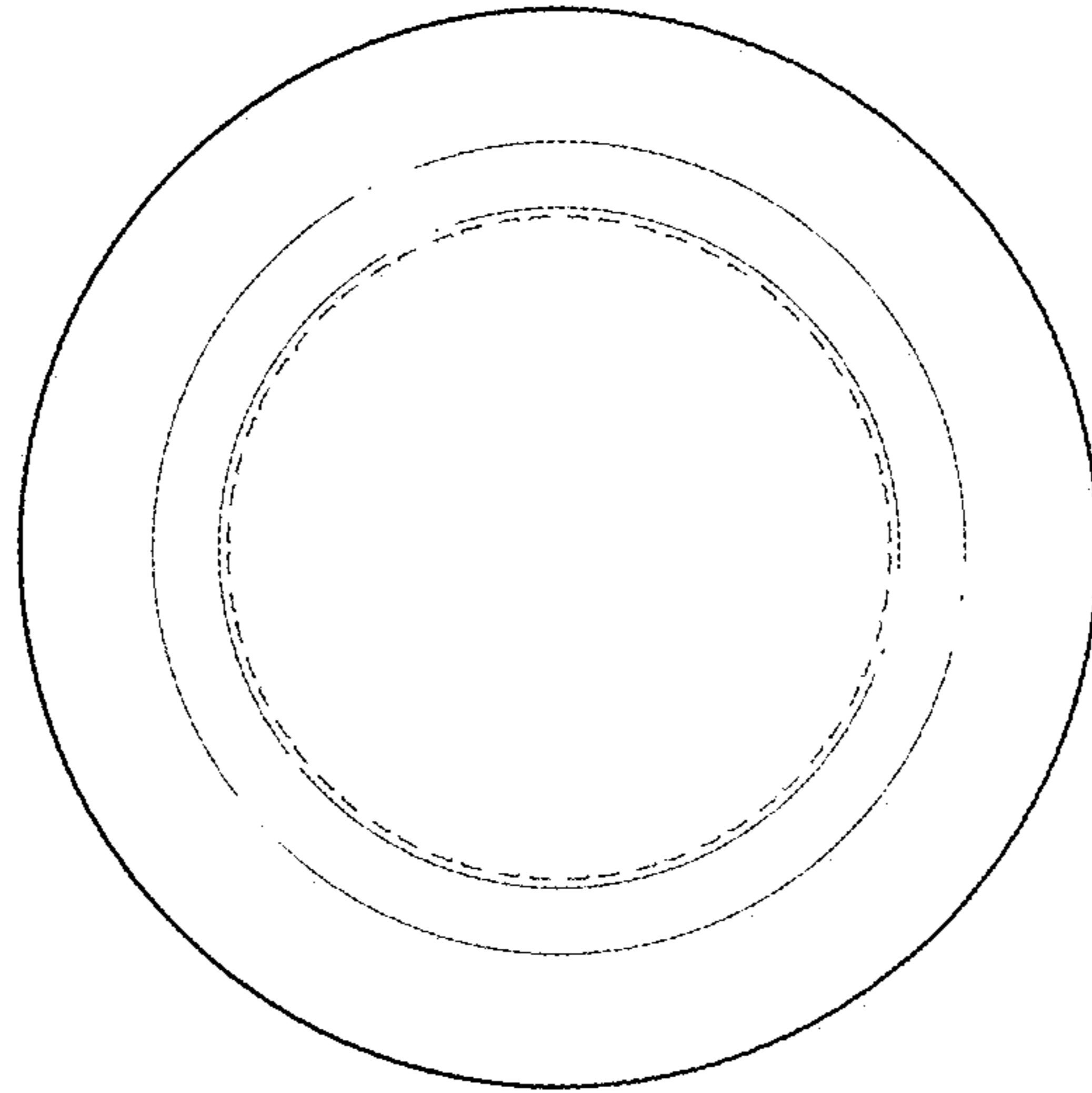


**FIG. 5**

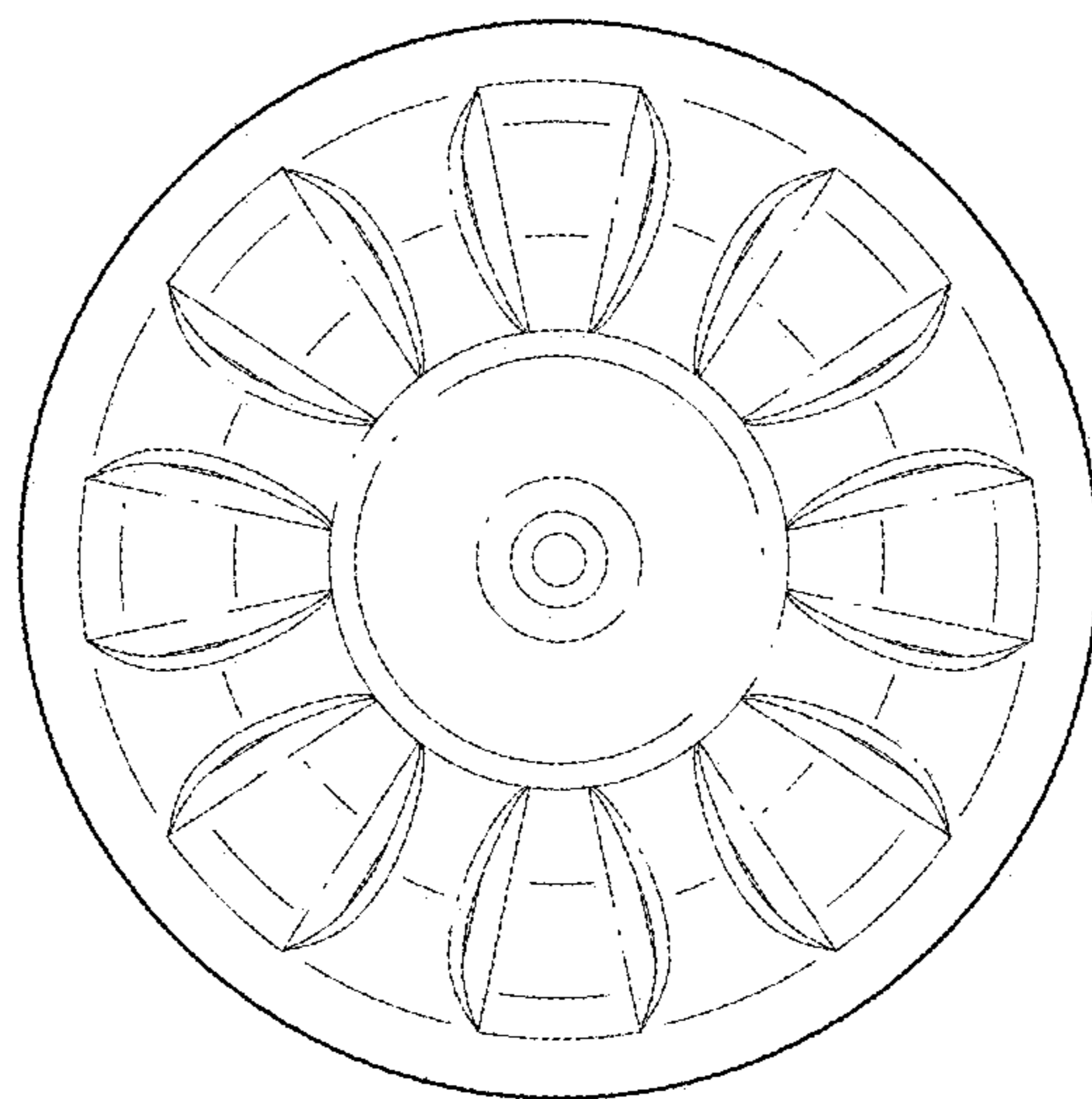


**FIG. 6**





**FIG. 7**



**FIG. 8**