



US00D874236S

(12) **United States Design Patent** (10) **Patent No.:** **US D874,236 S**
Spatz et al. (45) **Date of Patent:** **** Feb. 4, 2020**

(54) **DIRECTIONAL DRILLING ASSEMBLY**
(71) Applicants: **Edward C. Spatz**, San Marcos, TX
(US); **Michael R. Reese**, Houston, TX
(US); **David P. Miess**, Spring, TX
(US); **Gregory Prevost**, Spring, TX
(US)
(72) Inventors: **Edward C. Spatz**, San Marcos, TX
(US); **Michael R. Reese**, Houston, TX
(US); **David P. Miess**, Spring, TX
(US); **Gregory Prevost**, Spring, TX
(US)

4,485,879 A 12/1984 Kamp et al.
4,729,438 A 3/1988 Walker et al.
4,848,490 A 7/1989 Anderson
6,073,707 A 6/2000 Noe et al.
6,722,453 B1 4/2004 Crooks
8,162,081 B2 4/2012 Ballard et al.
D710,174 S * 8/2014 Moss D8/70
D710,175 S * 8/2014 Moss D8/70
D710,176 S * 8/2014 Santamarina D8/70
D713,706 S * 9/2014 Jing D15/140
D717,626 S * 11/2014 Dickrede D8/70
D731,277 S * 6/2015 Manwaring D8/70

(Continued)

OTHER PUBLICATIONS

(73) Assignee: **XR Lateral, LLC**, Houston, TX (US)

Spatz, et al.; U.S. Appl. No. 29/616,776, filed Sep. 8, 2017 [3 pages].

(**) Term: **15 Years**

(Continued)

(21) Appl. No.: **29/616,768**

Primary Examiner — Darlington Ly

(22) Filed: **Sep. 8, 2017**

(74) *Attorney, Agent, or Firm* — Michael S. McCoy;
Amatong McCoy LLC

(51) **LOC (12) Cl.** **08-05**

(52) **U.S. Cl.**
USPC **D8/70**

(57) **CLAIM**

(58) **Field of Classification Search**
USPC D8/70, 82, 85-87, 105; D15/139
CPC B25B 13/06; B25B 13/5091; B25B 15/00;
B25B 15/001; B25B 15/002; B25B
15/004; B25B 15/005; B25B 15/008;
B25B 15/02; B25B 15/04; B25B 17/00;
B25B 21/007; B25B 23/00; B25B
23/0035; B25B 23/005; B25B 23/12;
B25B 23/1405; B25B 27/18; B25B 31/12;
B25B 51/08; B25B 51/108; B25B
2251/66; B23P 15/00

The ornamental design for a directional drilling assembly, as shown and described.

DESCRIPTION

See application file for complete search history.

FIG. 1 is a front elevation view of a directional drilling assembly showing our new design;
FIG. 2 is a left side elevation view thereof;
FIG. 3 is a right side elevation view thereof;
FIG. 4 is a rear elevation view thereof;
FIG. 5 is a cross-sectional view thereof taken along line 5-5 in FIG. 1; and,
FIG. 6 is a cross-sectional view thereof taken along line 6-6 in FIG. 1.

The broken lines in the drawings illustrate portions of the directional drilling assembly that form no part of the claimed design.

(56) **References Cited**

U.S. PATENT DOCUMENTS

2,919,897 A 1/1960 Sims
3,561,549 A 2/1971 Garrison et al.
4,465,147 A 8/1984 Feenstra et al.

1 Claim, 1 Drawing Sheet

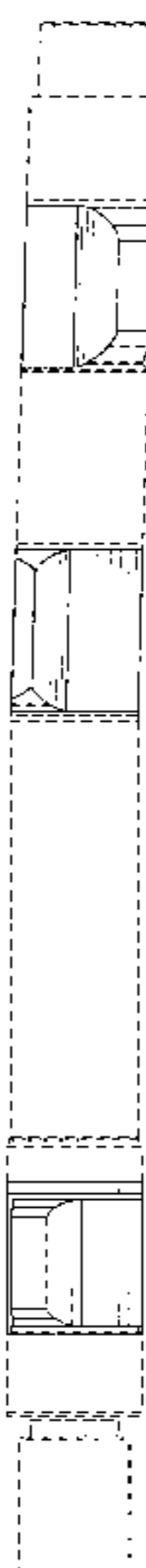

(56)

References Cited

U.S. PATENT DOCUMENTS

D732,364 S *	6/2015	Rinaldis	D8/70
9,163,460 B2	10/2015	Isenhour et al.	
D786,645 S *	5/2017	Svendsen	D15/139
D793,831 S *	8/2017	Russell	D8/70
D793,832 S *	8/2017	Russell	D8/70
D793,833 S *	8/2017	Russell	D8/70
D813,003 S *	3/2018	Chang	D8/70
9,963,938 B2	5/2018	Foote et al.	

OTHER PUBLICATIONS

Wenzel Downhole Tools; "Motor Handbook", 4th Edition Ver. 1.0a; Issue Date, Dec. 23, 2013 [135 pages].
Baker Hughes Incorporated; "Navi-Drill Motor Handbook"; revised Jan. 2017 [206 pages].
Cobra Downhole Motors; "Motor Manual" dated Feb. 2016 [126 pages].
National Oilwell Varco; "Drilling Motors", 2011 [20 pages].

Schlumberger; "Powerpak, Steerable Motor Handbook", 2004 [204 pages].
Spatz, et al.; U.S. Appl. No. 29/616,762, filed Sep. 8, 2017 [3 pages].
Spatz, et al.; U.S. Appl. No. 29/616,766, filed Sep. 8, 2017 [3 pages].
Spatz, et al.; U.S. Appl. No. 29/616,768, filed Sep. 8, 2017 [3 pages].
Spatz, et al.; U.S. Appl. No. 29/616,772, filed Sep. 8, 2017 [3 pages].
Spatz, et al.; U.S. Appl. No. 29/616,773, filed Sep. 8, 2017 [3 pages].
Tomahawk Downhole, L.L.C.; "The Cutting Edge in Mud Motors and Mud Motor Components, Motor Handbook" Rev. 7, 2011 [79 pages].
Wenzel Downhole Tools; "Motor Handbook", 4th Edition Ver. 1.0a; Issue Date, Dec. 23, 2013 [Part 1: 64 pages].
Wenzel Downhole Tools; "Motor Handbook", 4th Edition Ver. 1.0a; Issue Date, Dec. 23, 2013 [Part 2: 65 pages].

* cited by examiner

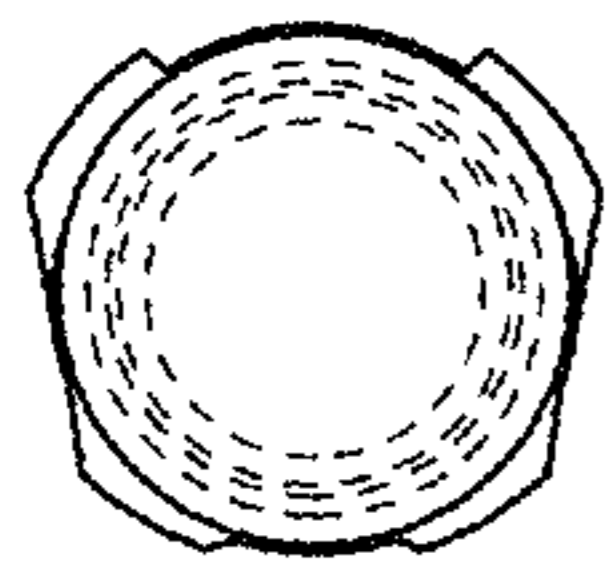

FIG. 5

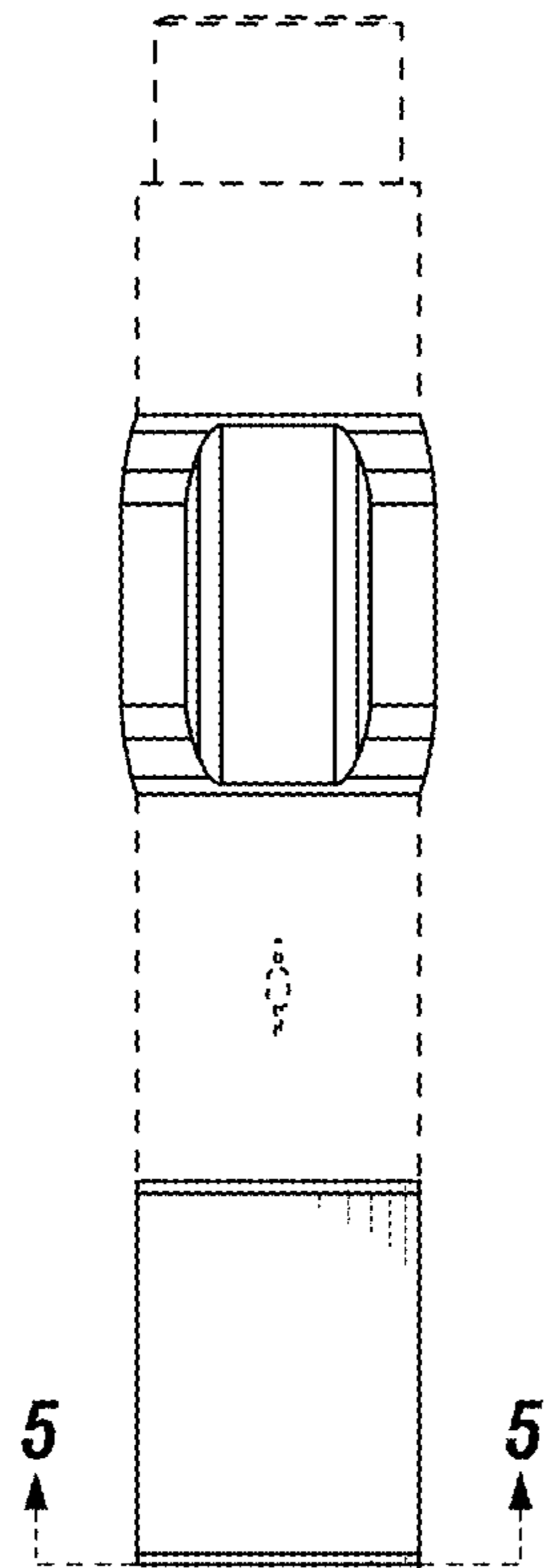

FIG. 1

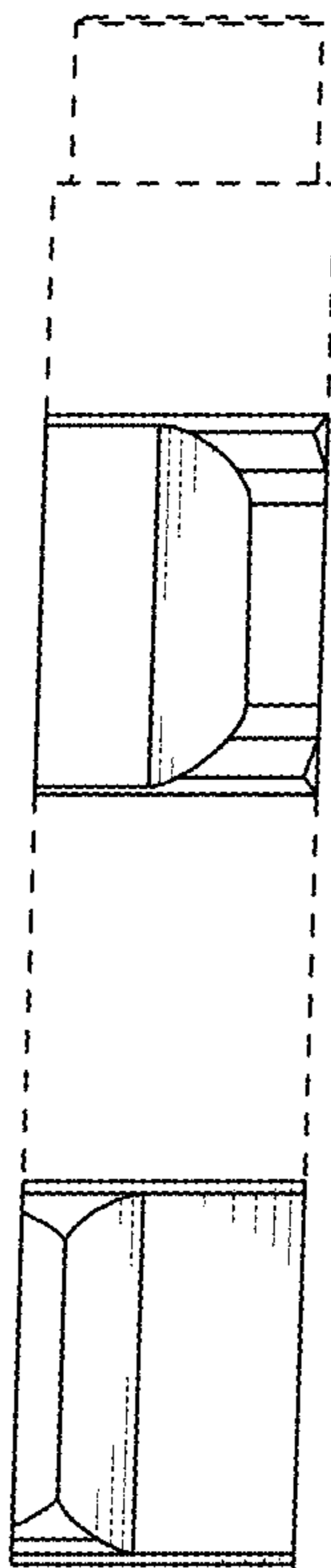

FIG. 2

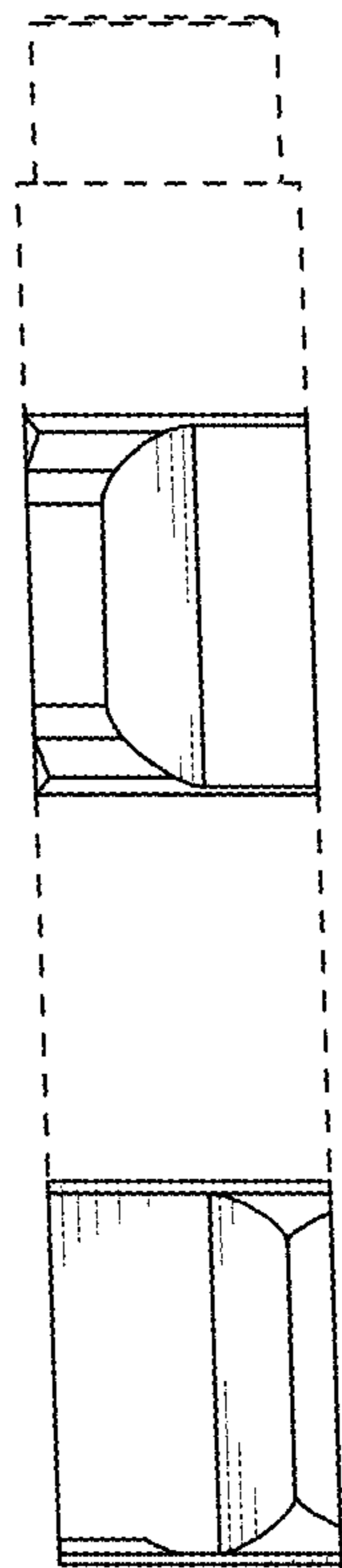

FIG. 3

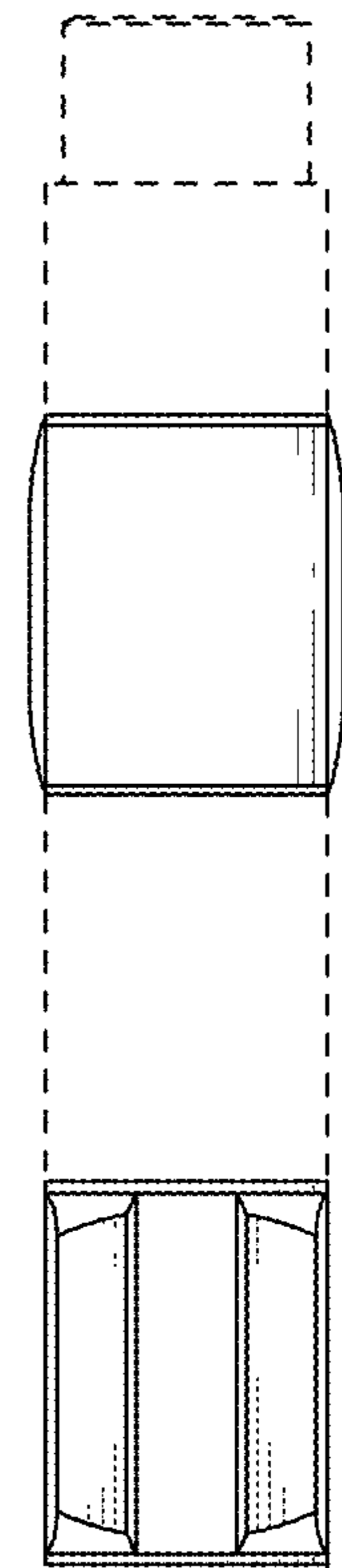

FIG. 4

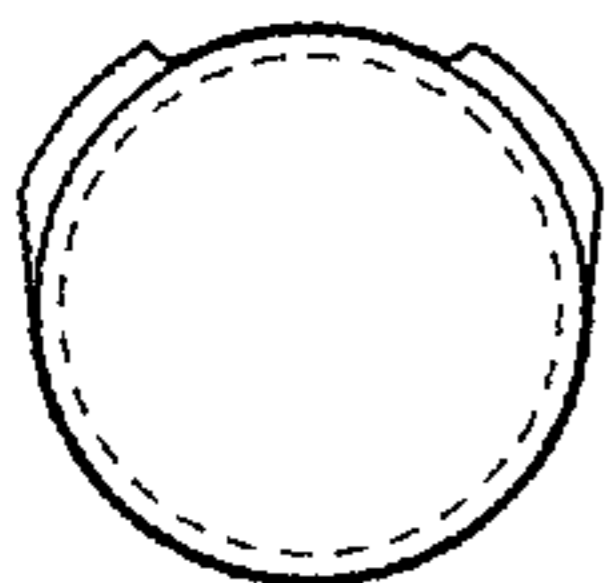

FIG. 6

