



US00D874069S

(12) **United States Design Patent**
Dunton

(10) **Patent No.:** **US D874,069 S**
(45) **Date of Patent:** **** Jan. 28, 2020**

(54) **PAD KIT FOR A HELMET**

(71) Applicant: **Nick M. Dunton**, Wapitl, WY (US)

(72) Inventor: **Nick M. Dunton**, Wapitl, WY (US)

(**) Term: **15 Years**

(21) Appl. No.: **29/654,344**

(22) Filed: **Jun. 22, 2018**

(51) **LOC (12) Cl.** **29-02**

(52) **U.S. Cl.**
USPC **D29/122**

(58) **Field of Classification Search**

USPC D29/102-107, 122; 2/6.1-6.3, 6.5, 6.7,
2/172, 175.1, 175.6, 175.7, 195.1, 209,
2/410, 422-425, 455, 909, 918, 920;
D2/891; D5/63; D24/190, 191;
128/864, 866, 867
CPC A42B 3/00; A42B 3/163; A42B 3/166;
A42B 3/16; A42B 3/18; A42B 3/20;
A42B 3/22; A42B 3/221; A42B 3/228;
A42B 3/066; A42B 3/06; A63B 71/10;
A61F 11/008

See application file for complete search history.

(56) **References Cited**

U.S. PATENT DOCUMENTS

3,174,155 A 3/1965 Pitman
3,815,152 A 6/1974 Bednarczuk et al.
4,223,409 A 9/1980 Lee

(Continued)

Primary Examiner — Randall H Gholson

(74) *Attorney, Agent, or Firm* — Dunlap Codding, P.C.

(57) **CLAIM**

The ornamental design for a pad kit for a helmet, as shown and described.

DESCRIPTION

FIG. 1 is a perspective view of a pad kit for a helmet showing my new design;

FIG. 2 is a front elevational view thereof;
FIG. 3 is a rear elevational view thereof;
FIG. 4 is a side elevational view thereof;
FIG. 5 is a side elevational view of a side opposite that shown in FIG. 4;
FIG. 6 is a top plan view thereof;
FIG. 7 is a bottom plan view thereof;
FIG. 8 is a perspective view of a pad kit for a helmet showing my new design;
FIG. 9 is a front elevational view of the pad of FIG. 8;
FIG. 10 is a rear elevational view of the pad of FIG. 8;
FIG. 11 is a side elevational view of the pad of FIG. 8;
FIG. 12 is a side elevational view of a side opposite that shown in FIG. 11;
FIG. 13 is a top plan view of the pad of FIG. 8;
FIG. 14 is a bottom plan view of the pad of FIG. 8;
FIG. 15 is a perspective view of another pad kit for a helmet showing my new design;
FIG. 16 is a front elevational view of the pad of FIG. 15;
FIG. 17 is a rear elevational view of the pad of FIG. 15;
FIG. 18 is a side elevational view of the pad of FIG. 15;
FIG. 19 is a side elevational view of a side opposite that shown in FIG. 18;
FIG. 20 is a top plan view of the pad of FIG. 15;
FIG. 21 is a bottom plan view of the pad of FIG. 15;
FIG. 22 is a perspective view of another pad kit for a helmet showing my new design;
FIG. 23 is a front elevational view of the pad of FIG. 22;
FIG. 24 is a rear elevational view of the pad of FIG. 22;
FIG. 25 is a side elevational view of the pad of FIG. 22;
FIG. 26 is a side elevational view of a side opposite that shown in FIG. 25;
FIG. 27 is a top plan view of the pad of FIG. 22; and,
FIG. 28 is a bottom plan view of the pad of FIG. 22.
The individual pads are shown separately for clarity.
The broken lines in the drawings are for the purpose of illustrating environment only and form no part of the claimed design.

1 Claim, 11 Drawing Sheets

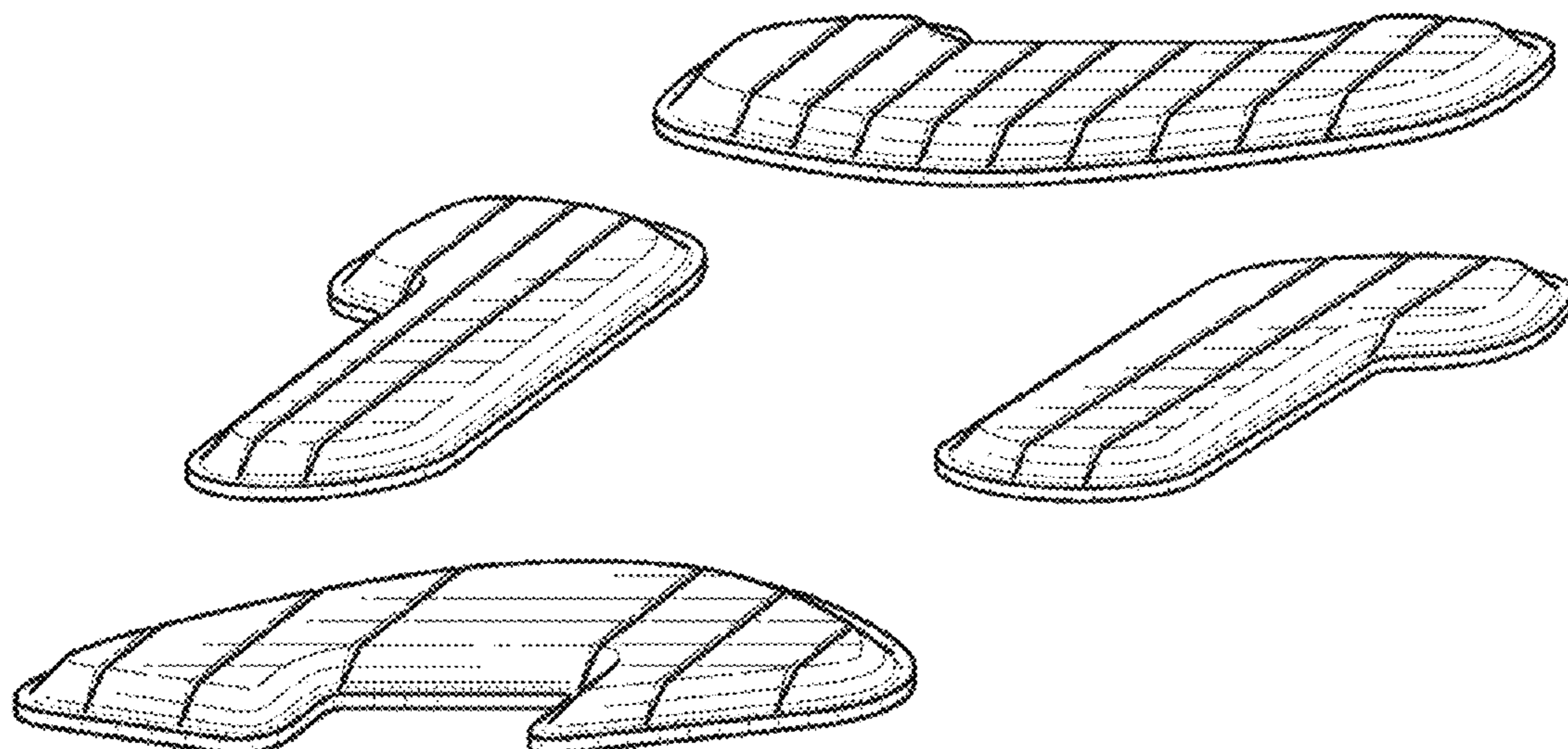

(56)

References Cited

U.S. PATENT DOCUMENTS

4,660,230	A	4/1987	Mayling	
4,937,888	A	7/1990	Straus	
6,272,692	B1	8/2001	Abraham	
6,314,586	B1	11/2001	Duguid	
6,389,607	B1	5/2002	Wood	
D617,503	S *	6/2010	Szalkowski D29/122
D640,422	S *	6/2011	Green D29/122
D670,868	S *	11/2012	Harris D29/122
D713,603	S *	9/2014	Vito A42B 3/125 D29/102
8,826,468	B2	9/2014	Harris	
8,938,817	B1	1/2015	Baldi	
8,966,671	B2	3/2015	Rumbaugh	
9,119,431	B2	9/2015	Bain	
9,314,063	B2	4/2016	Bologna et al.	
D769,540	S *	10/2016	Meier D29/122
D784,627	S *	4/2017	Williams D29/122
D784,628	S *	4/2017	Fleming D29/122
9,629,409	B1	4/2017	Cannon, Jr. et al.	
9,808,042	B2	11/2017	Hoying et al.	
2011/0179557	A1	7/2011	Rabie	
2012/0036619	A1	2/2012	Ytterborn et al.	
2012/0317705	A1	12/2012	Lindsay	
2013/0298316	A1	11/2013	Jacob	
2014/0259309	A1	9/2014	Pettersen	

* cited by examiner

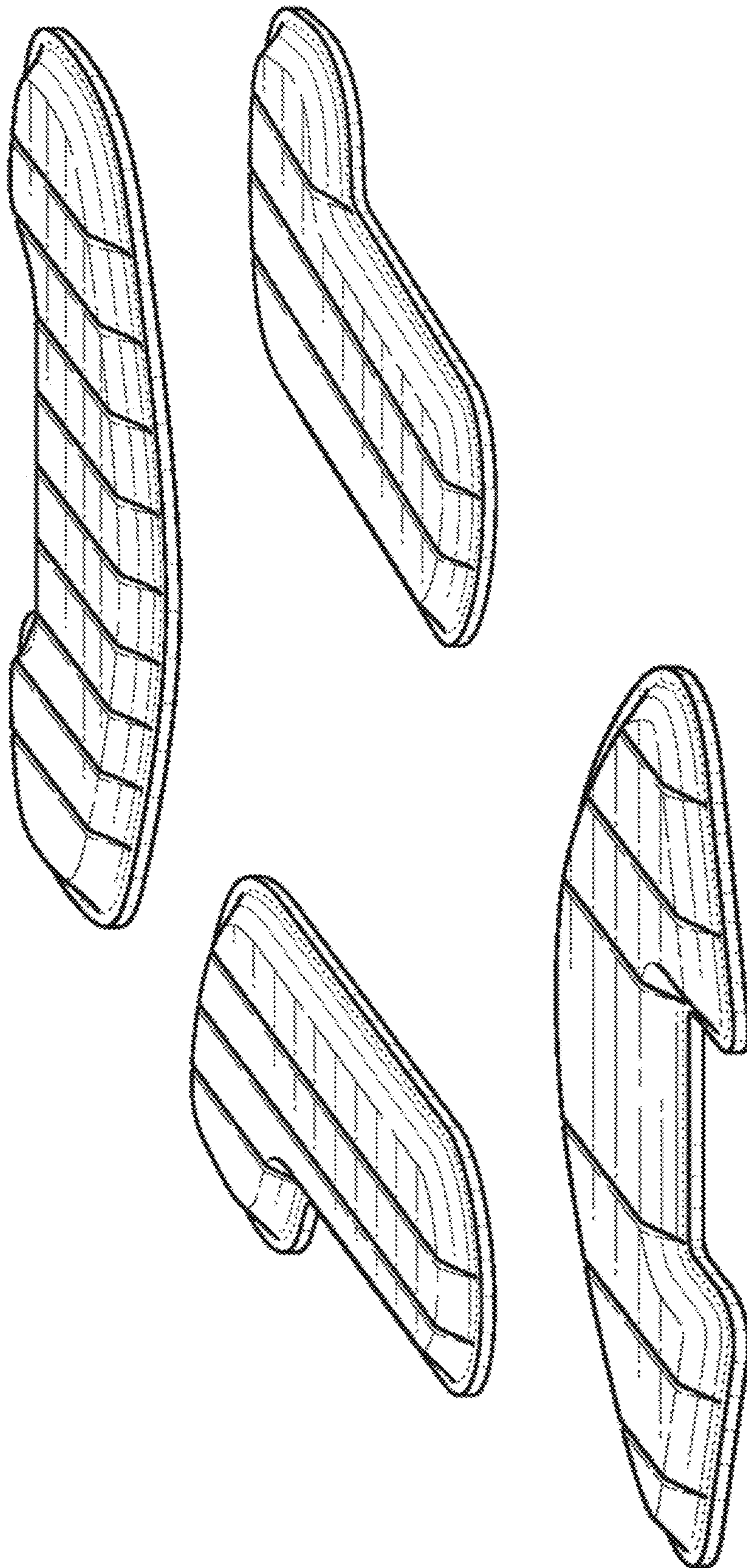

FIG. 1

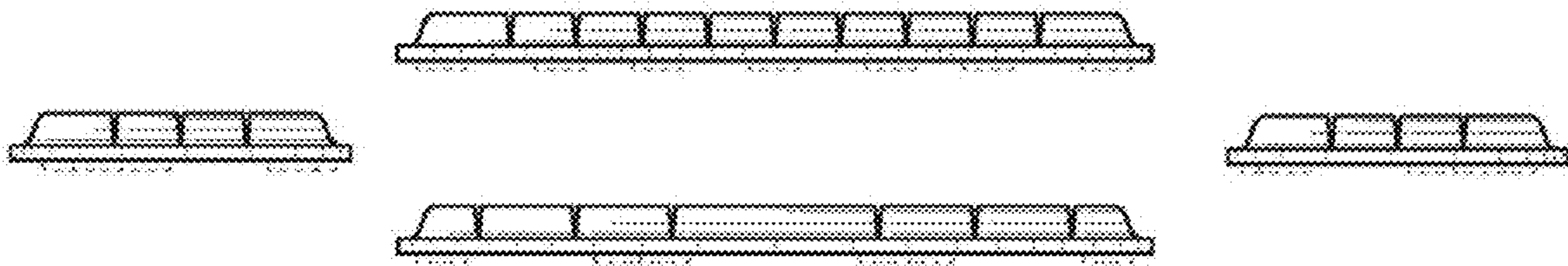

FIG. 2

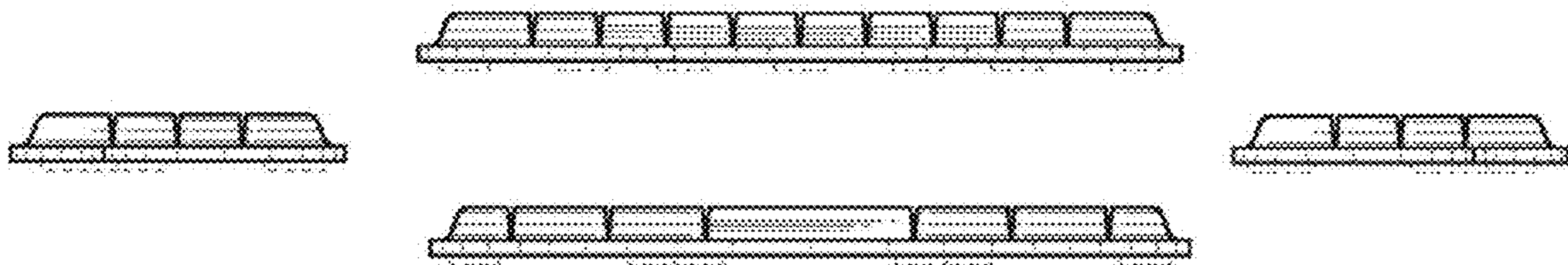

FIG. 3

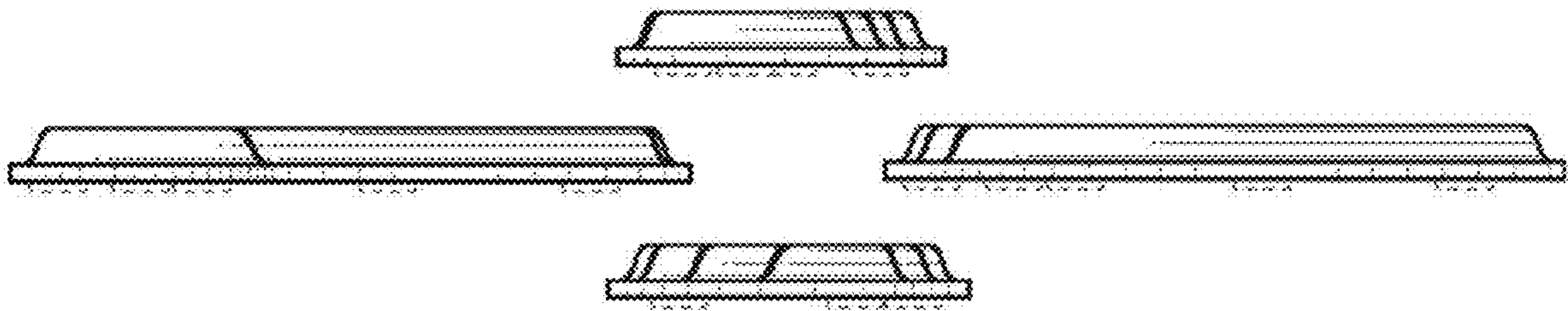

FIG. 4

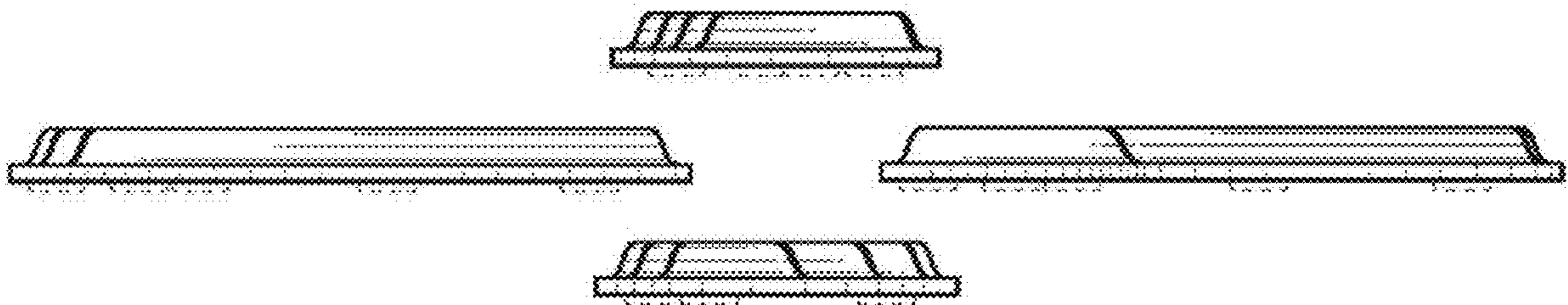

FIG. 5

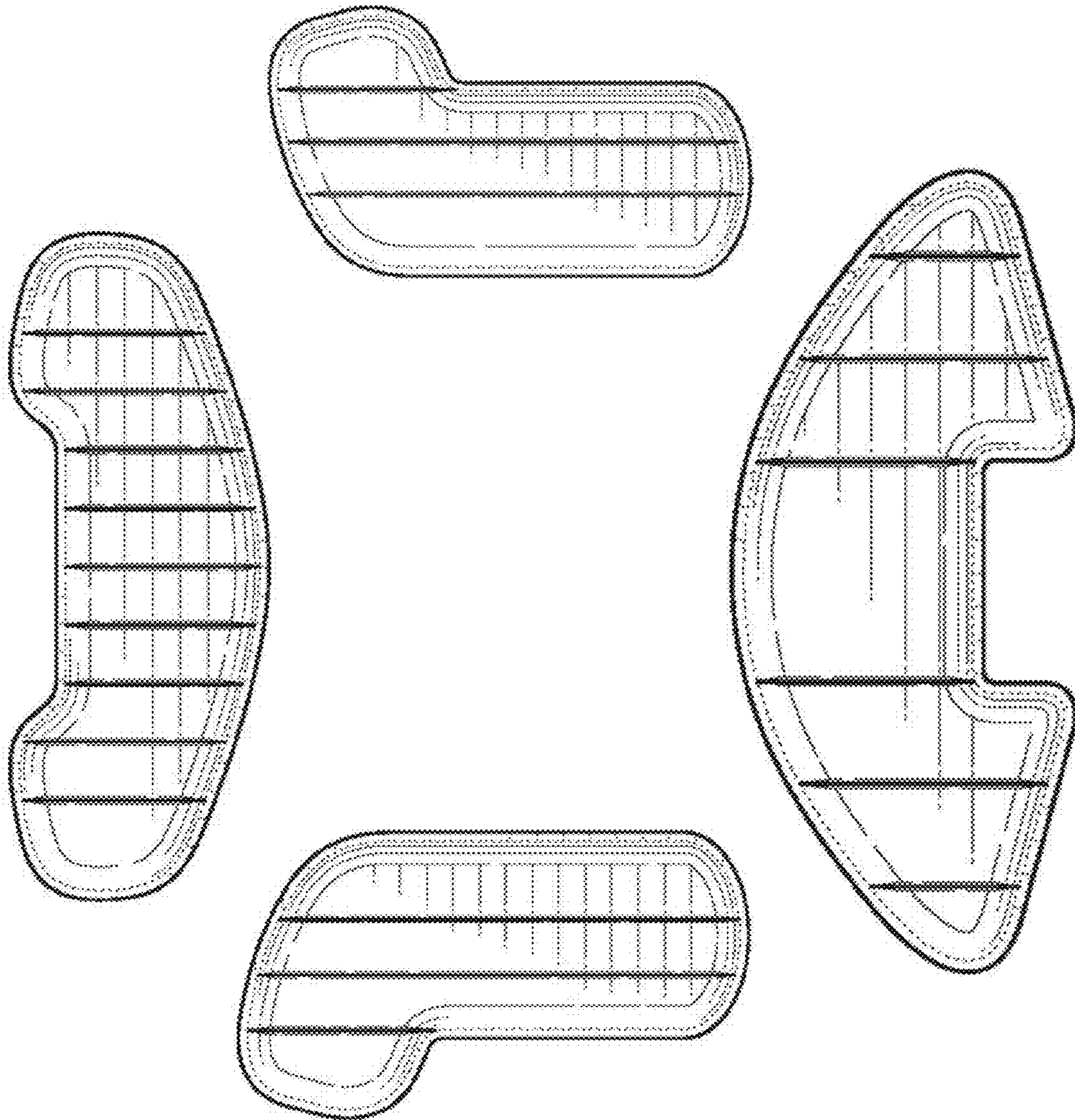

FIG. 6

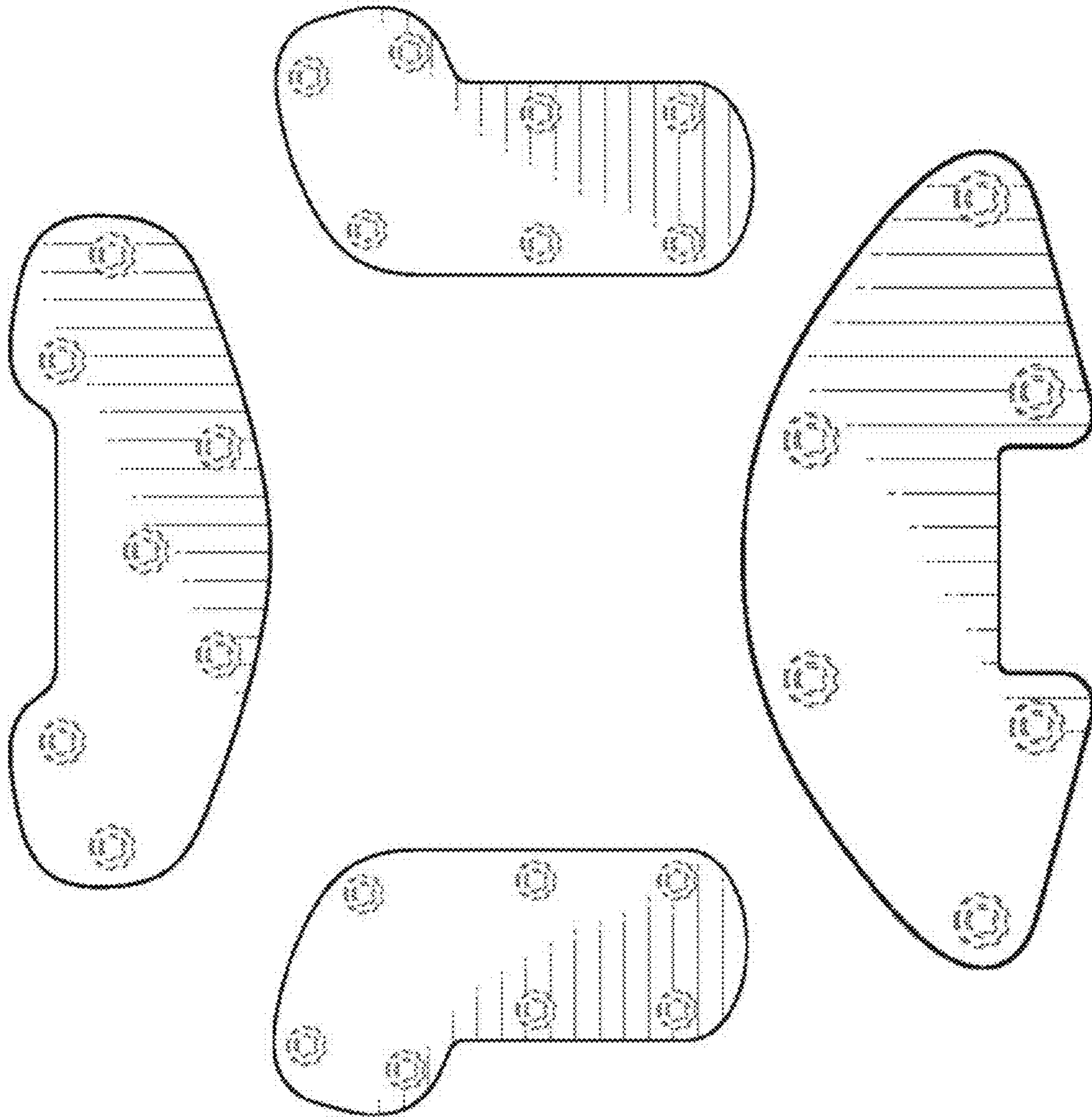

FIG. 7

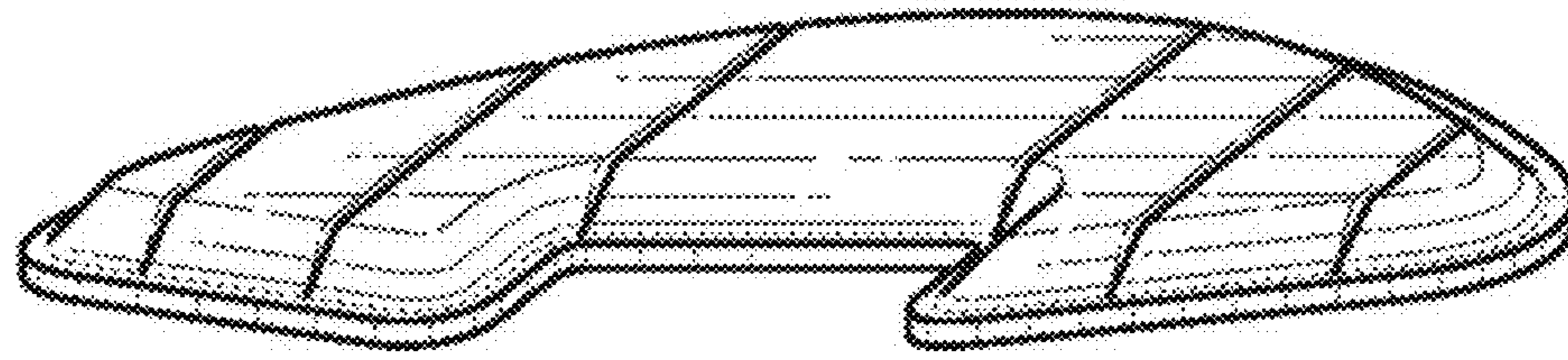

FIG. 8

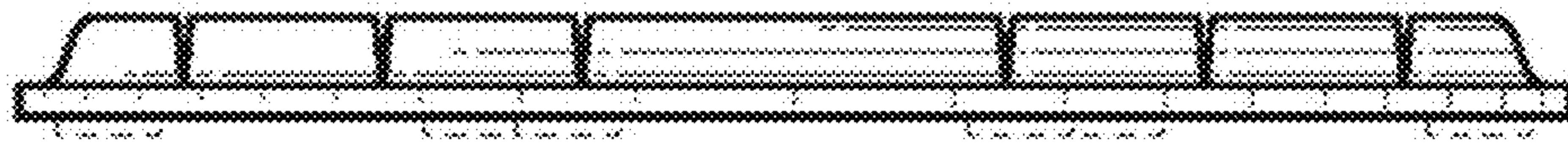

FIG. 9

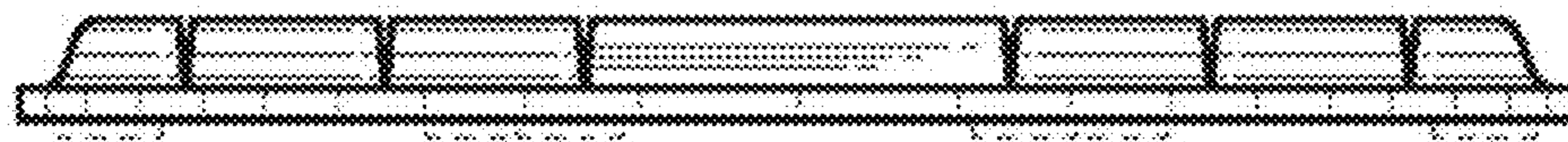

FIG. 10



FIG. 11



FIG. 12

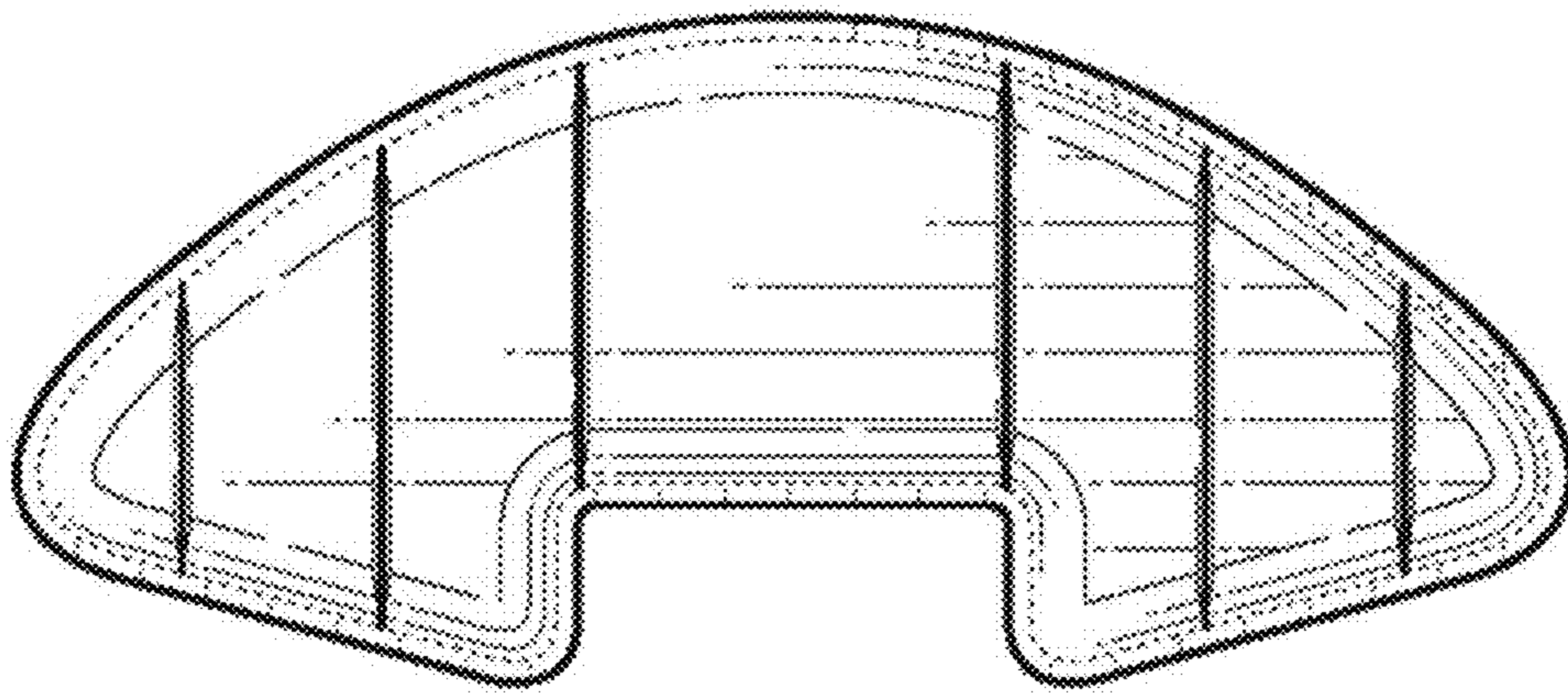

FIG. 13

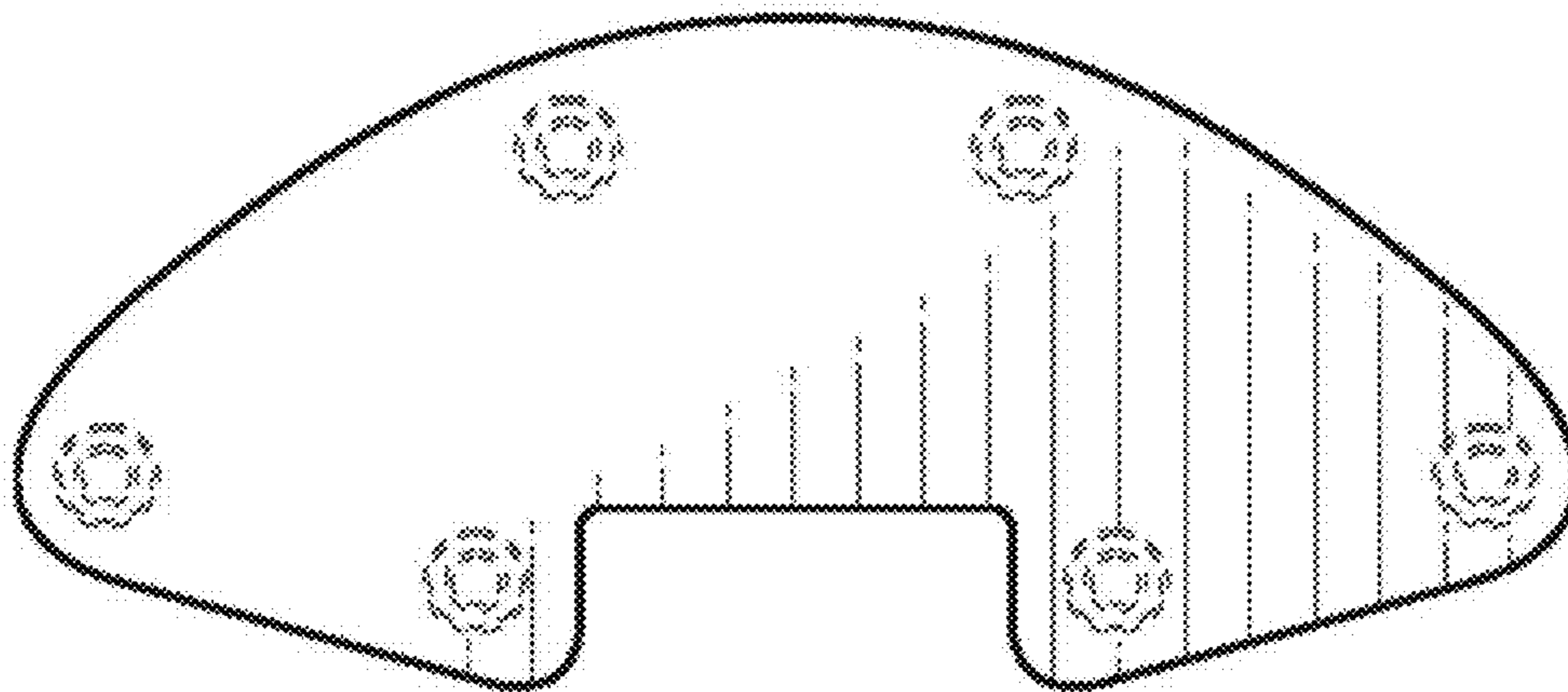

FIG. 14

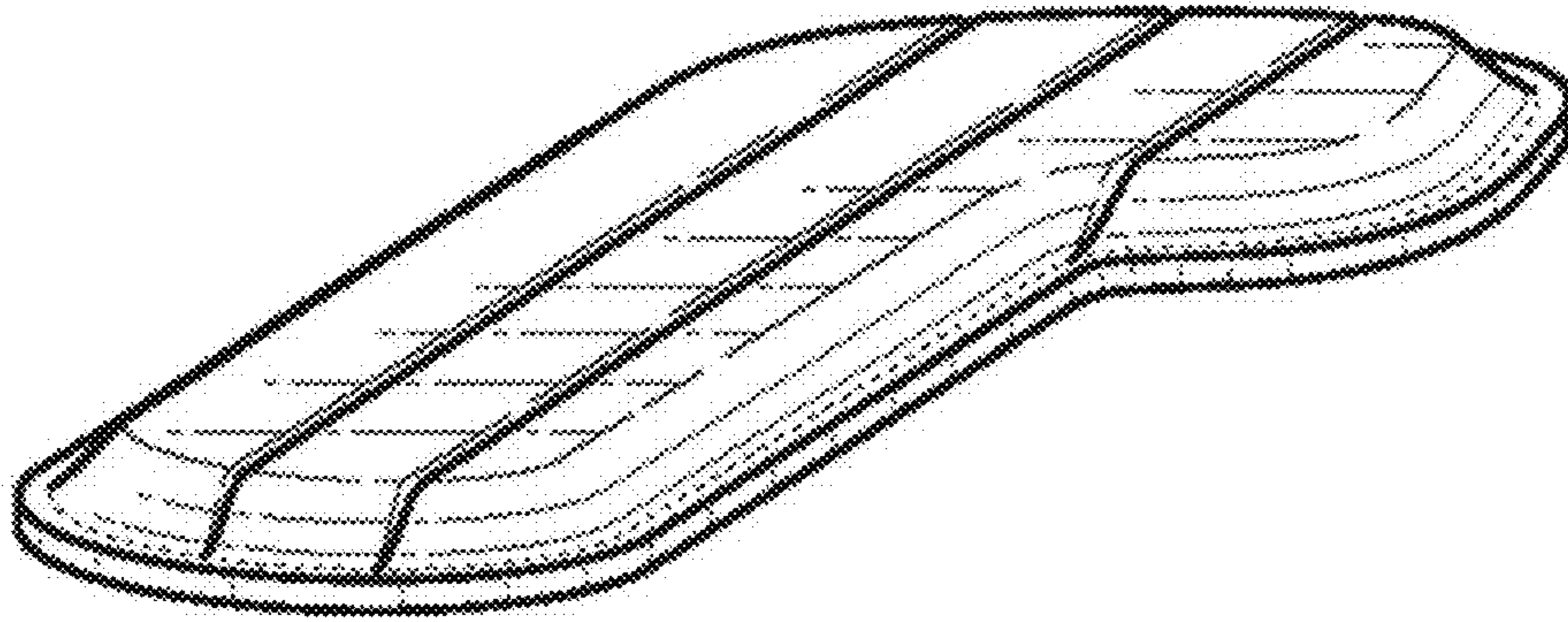

FIG. 15



FIG. 16

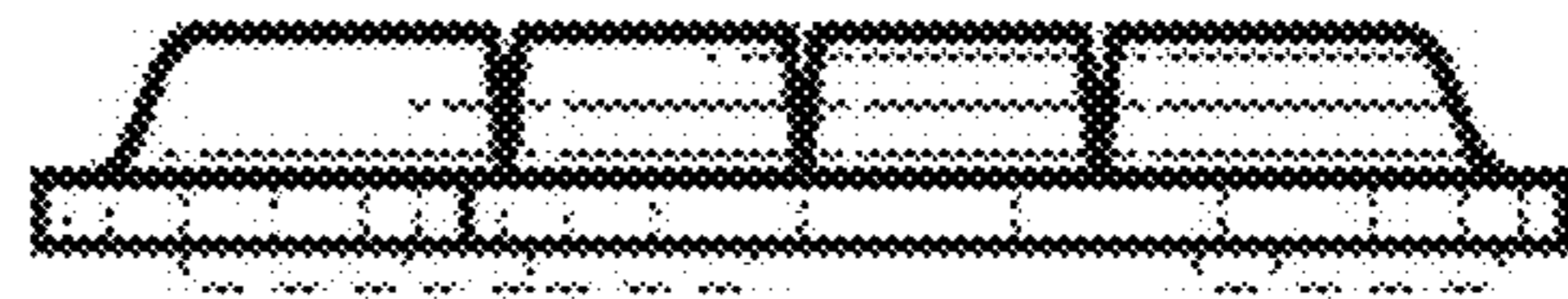

FIG. 17



FIG. 18

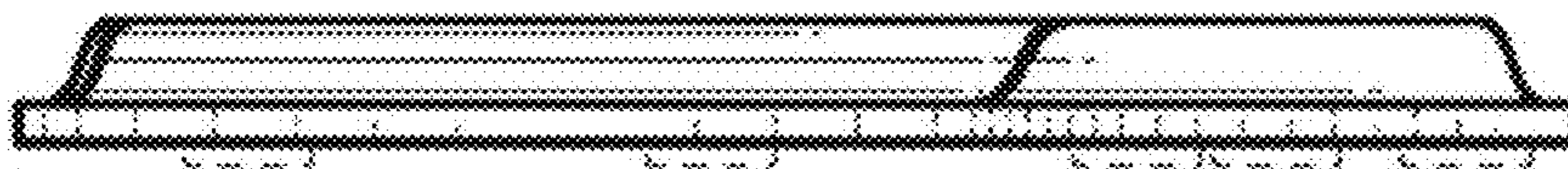

FIG. 19

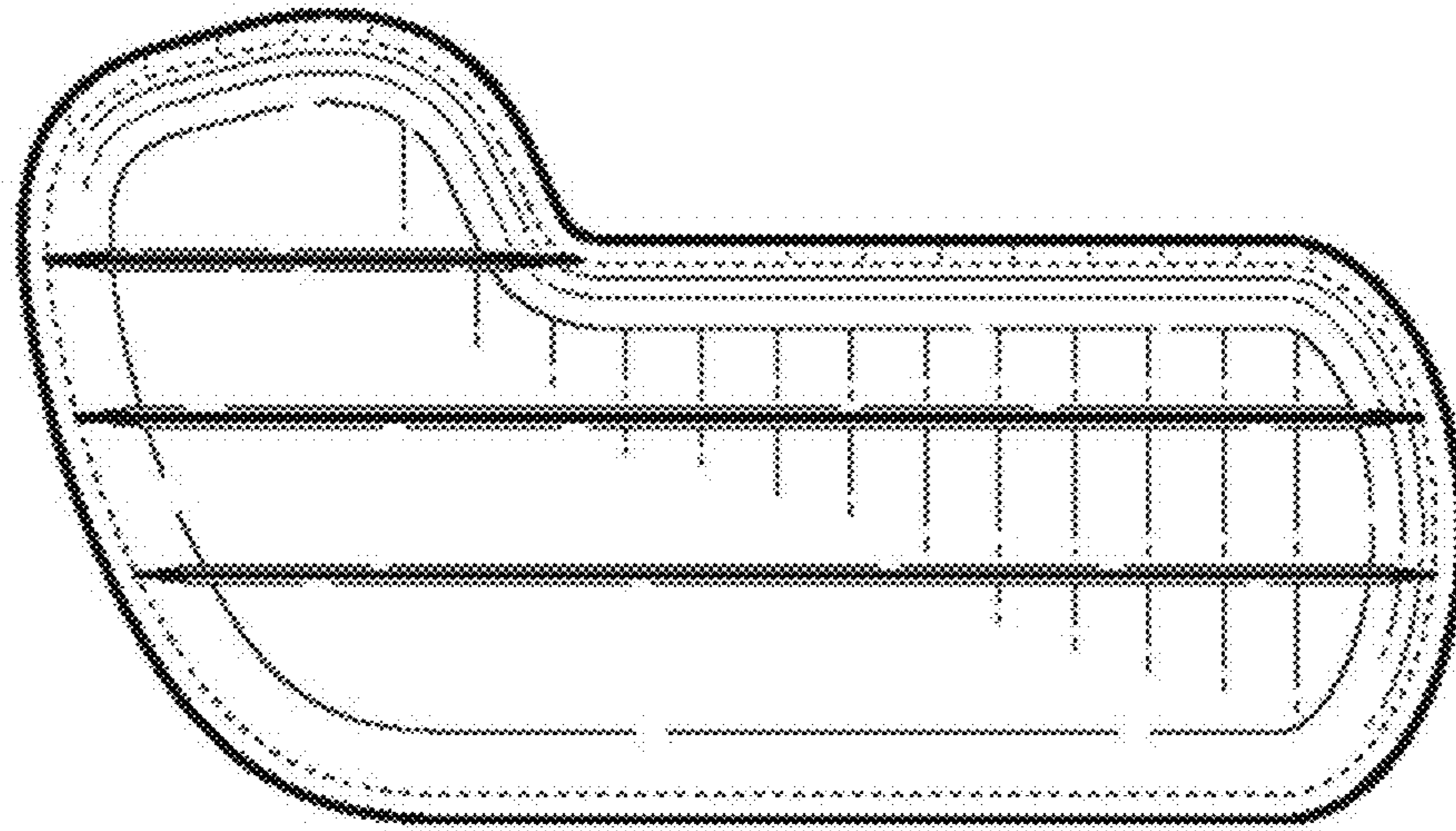

FIG. 20

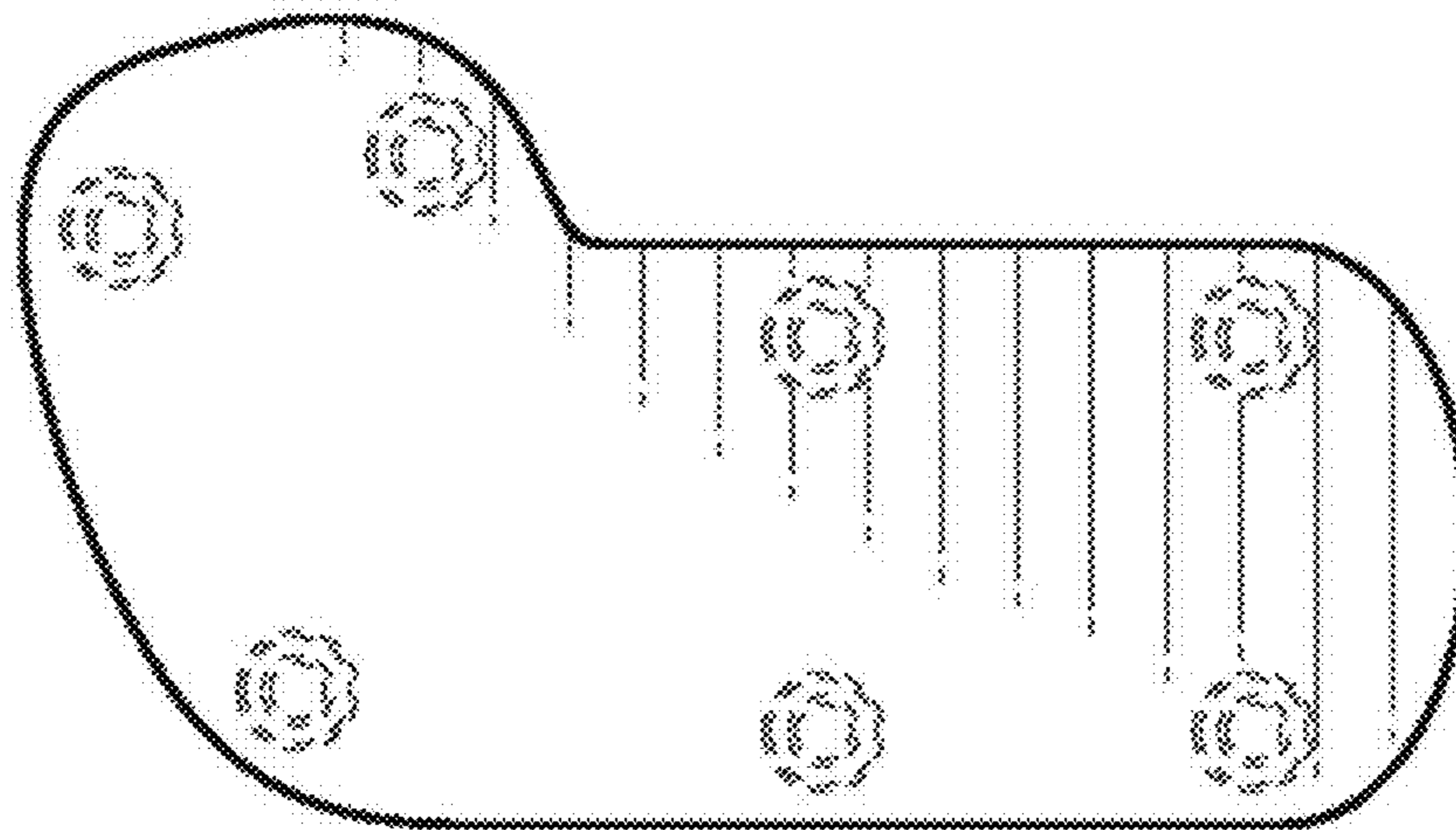

FIG. 21

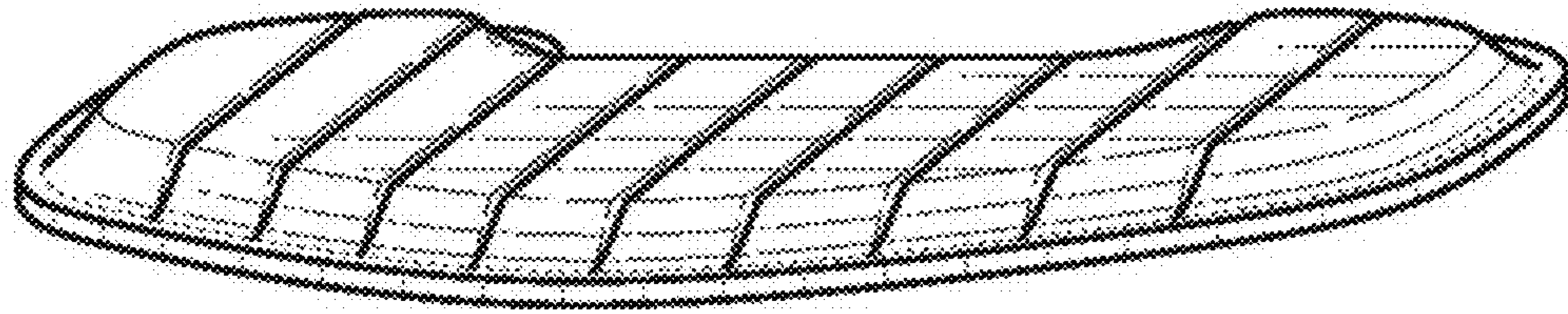

FIG. 22

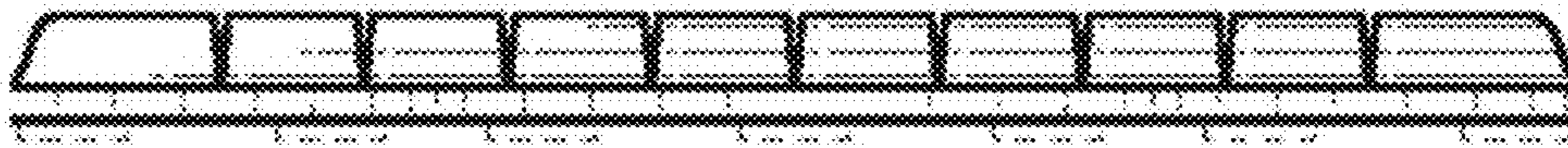

FIG. 23

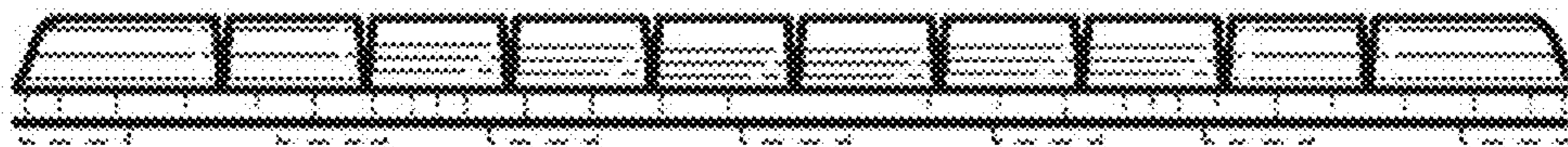

FIG. 24

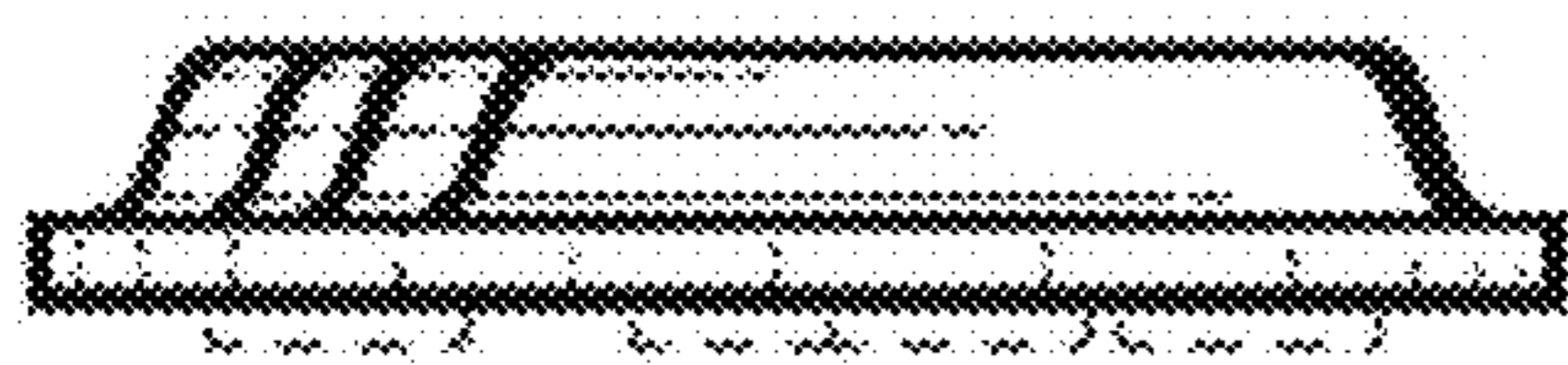

FIG. 25



FIG. 26

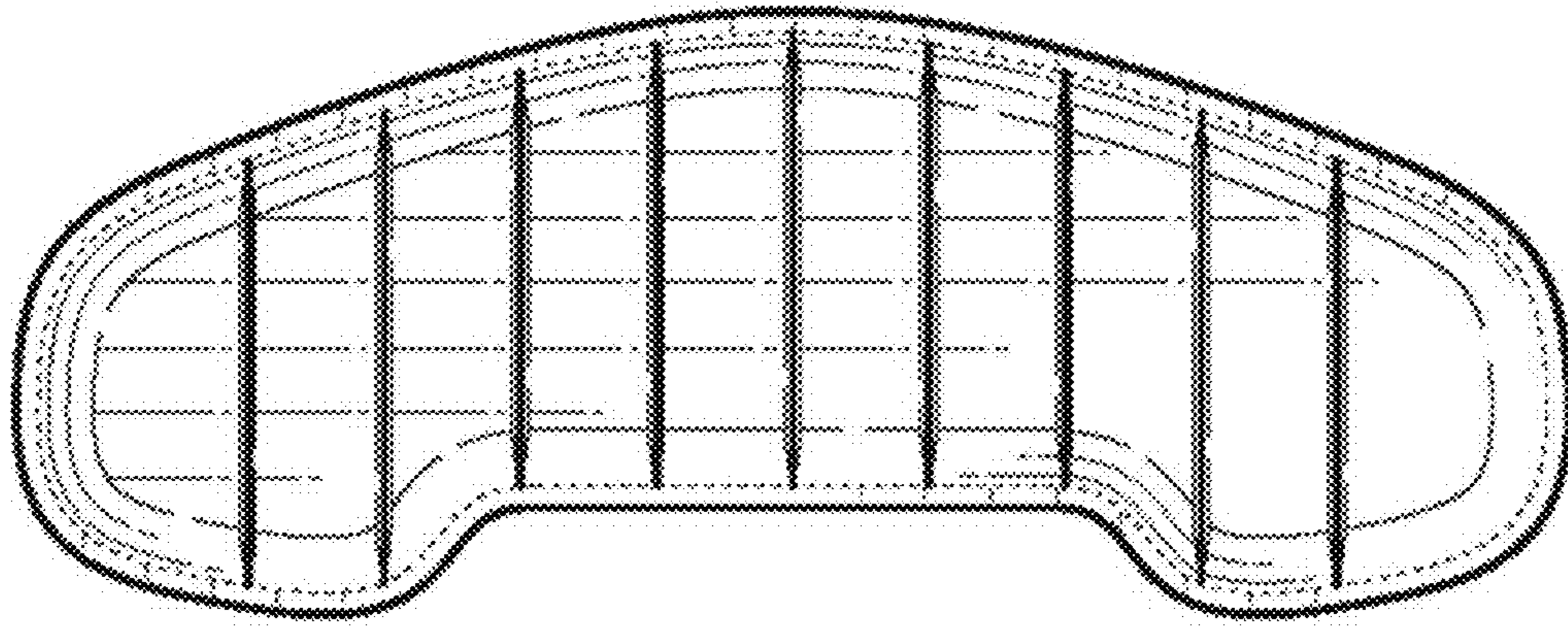

FIG. 27

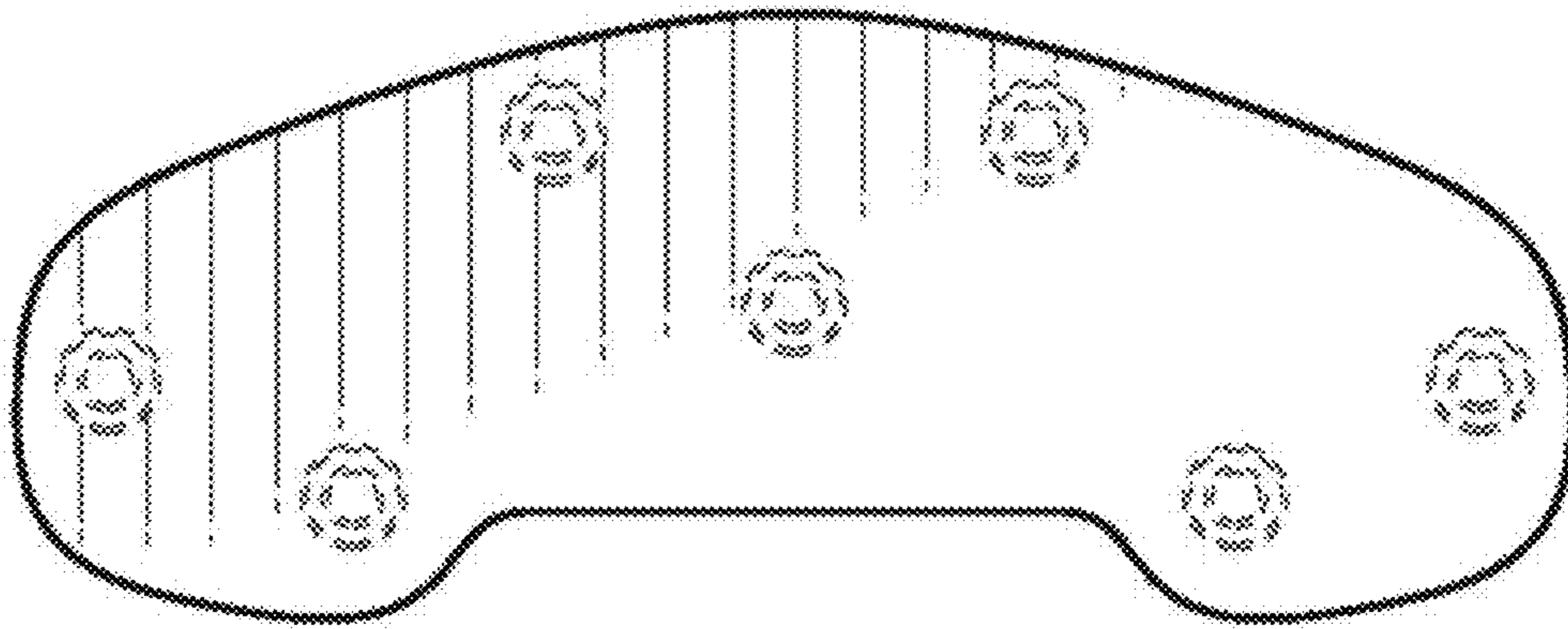

FIG. 28