

US00D874009S

(12) **United States Design Patent**  
**Dlabač**

(10) **Patent No.:** **US D874,009 S**  
(45) **Date of Patent:** **\*\* Jan. 28, 2020**

(54) **MEDICAL DEVICE**

(71) Applicant: **BTL Industries, Ltd.**, Sofia (BG)

(72) Inventor: **Ivan Dlabač**, Brandýs nad Labem (CZ)

(73) Assignee: **BTL INDUSTRIES LTD.**, Sofia (BG)

(\*\*) Term: **15 Years**

(21) Appl. No.: **29/643,574**

(22) Filed: **Apr. 10, 2018**

(51) **LOC (12) Cl.** ..... **24-02**

(52) **U.S. Cl.**  
USPC ..... **D24/185**

(58) **Field of Classification Search**  
USPC ..... D24/185, 164, 160, 158, 167; D34/14  
CPC ..... A61B 50/30; A61G 12/001  
See application file for complete search history.

(56) **References Cited**

**U.S. PATENT DOCUMENTS**

|                |         |             |       |             |
|----------------|---------|-------------|-------|-------------|
| D486,915 S *   | 2/2004  | Warschewske | ..... | D24/185     |
| D550,362 S *   | 9/2007  | Olivera     | ..... | D24/185     |
| D561,342 S *   | 2/2008  | Zimmer      | ..... | D24/185     |
| D621,513 S *   | 8/2010  | Cinquabre   | ..... | D24/185     |
| 8,286,977 B2 * | 10/2012 | Butler      | ..... | A61G 12/001 |
|                |         |             |       | 280/47.34   |
| D687,147 S *   | 7/2013  | Yoshida     | ..... | D24/185     |
| D702,840 S *   | 4/2014  | Blomquist   | ..... | D24/164     |
| D702,842 S *   | 4/2014  | Hyde        | ..... | D24/185     |
| D712,042 S *   | 8/2014  | Chung       | ..... | D24/185     |
| D730,011 S *   | 5/2015  | McRorie     | ..... | D34/14      |

|                 |         |           |       |            |
|-----------------|---------|-----------|-------|------------|
| D735,866 S *    | 8/2015  | Assa      | ..... | D24/185    |
| D739,538 S *    | 9/2015  | Bernal    | ..... | D24/185    |
| D753,310 S *    | 4/2016  | Thakar    | ..... | D24/185    |
| 9,463,069 B2 *  | 10/2016 | Dunworth  | ..... | A61B 50/30 |
| D776,279 S *    | 1/2017  | Newman    | ..... | D24/164    |
| D777,927 S *    | 1/2017  | Choudhary | ..... | D24/167    |
| D790,066 S *    | 6/2017  | Lei       | ..... | D24/158    |
| D796,679 S *    | 9/2017  | Dekock    | ..... | D24/158    |
| D827,139 S *    | 8/2018  | Henderson | ..... | D24/160    |
| D844,792 S *    | 4/2019  | Choe      | ..... | D24/186    |
| 10,350,015 B2 * | 7/2019  | Toth      |       |            |
| 10,376,331 B2 * | 8/2019  | Cooper    |       |            |

\* cited by examiner

*Primary Examiner* — Rhea Shields

(74) *Attorney, Agent, or Firm* — Riverside Law LLP

(57) **CLAIM**

I claim the ornamental design for a medical device, as shown and described.

**DESCRIPTION**

FIG. 1 is a front-left perspective view of a medical device; FIG. 2 is a back-left perspective view thereof; FIG. 3 is a front view thereof; FIG. 4 is a back view thereof; FIG. 5 is a right view thereof; FIG. 6 is a left view thereof; FIG. 7 is a top view thereof; and, FIG. 8 is a bottom view thereof.

In the drawings, the broken lines are for the purpose of illustrating environment only and form no part of the claimed design.

**1 Claim, 8 Drawing Sheets**

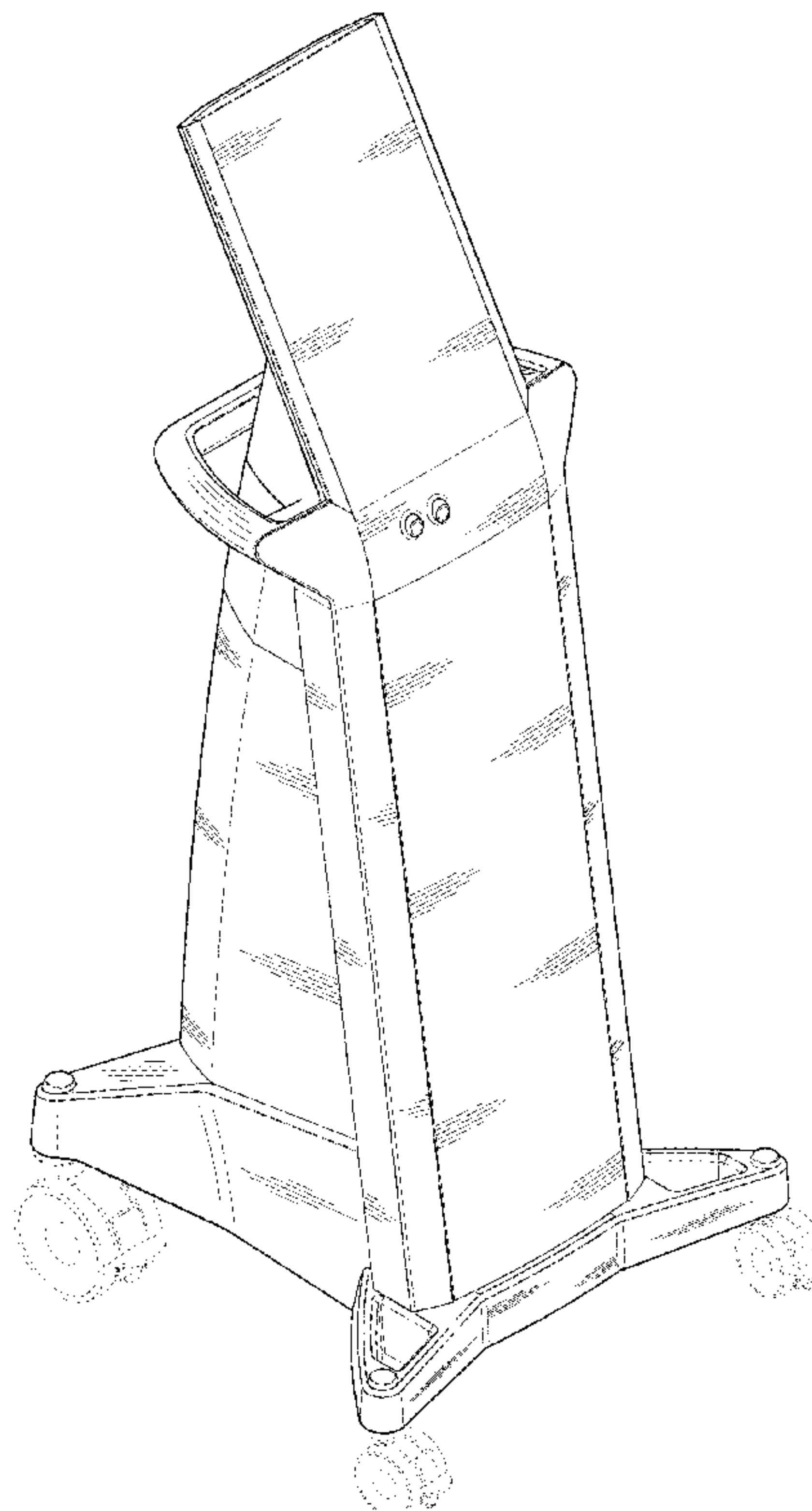

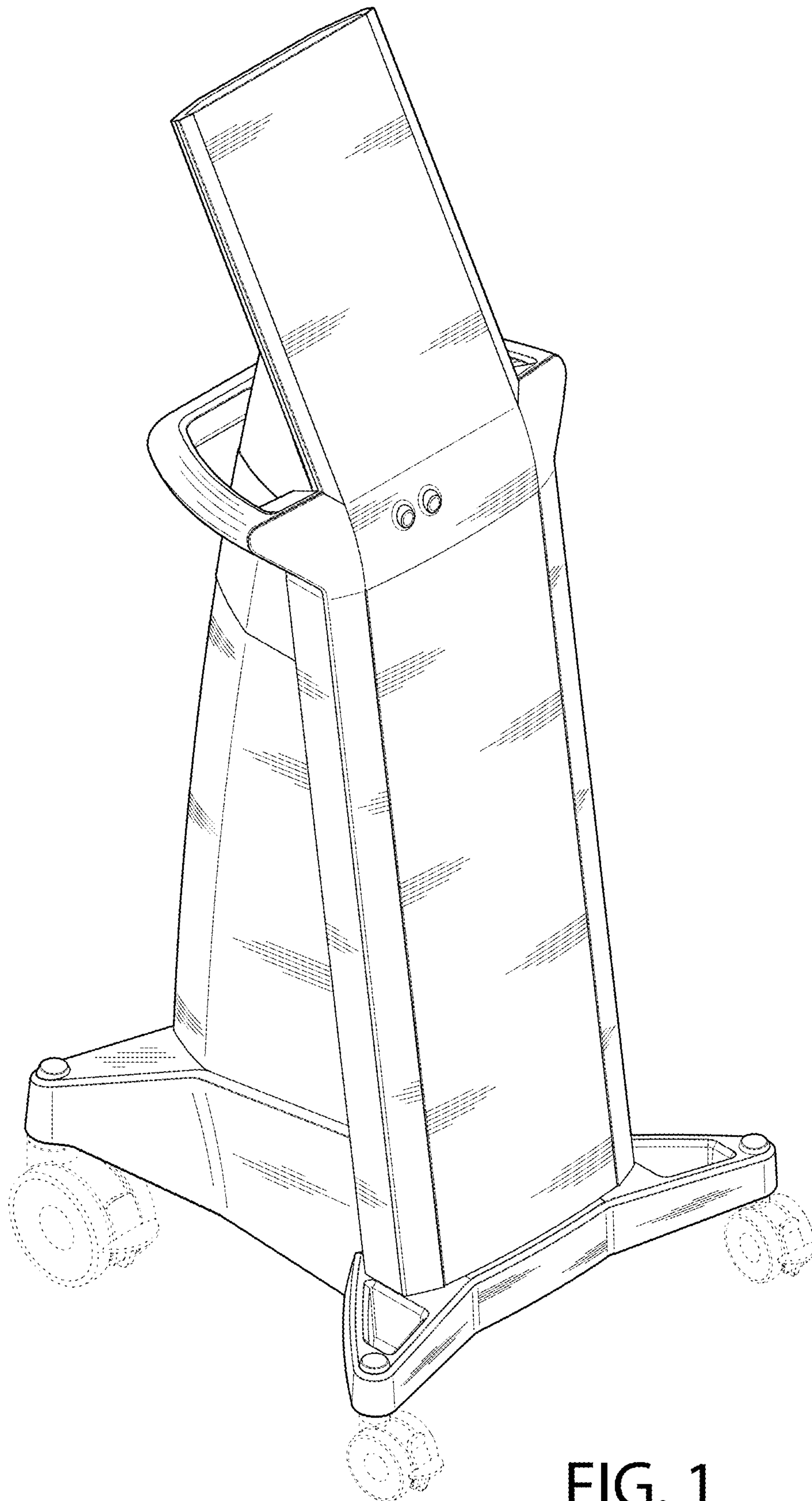

FIG. 1

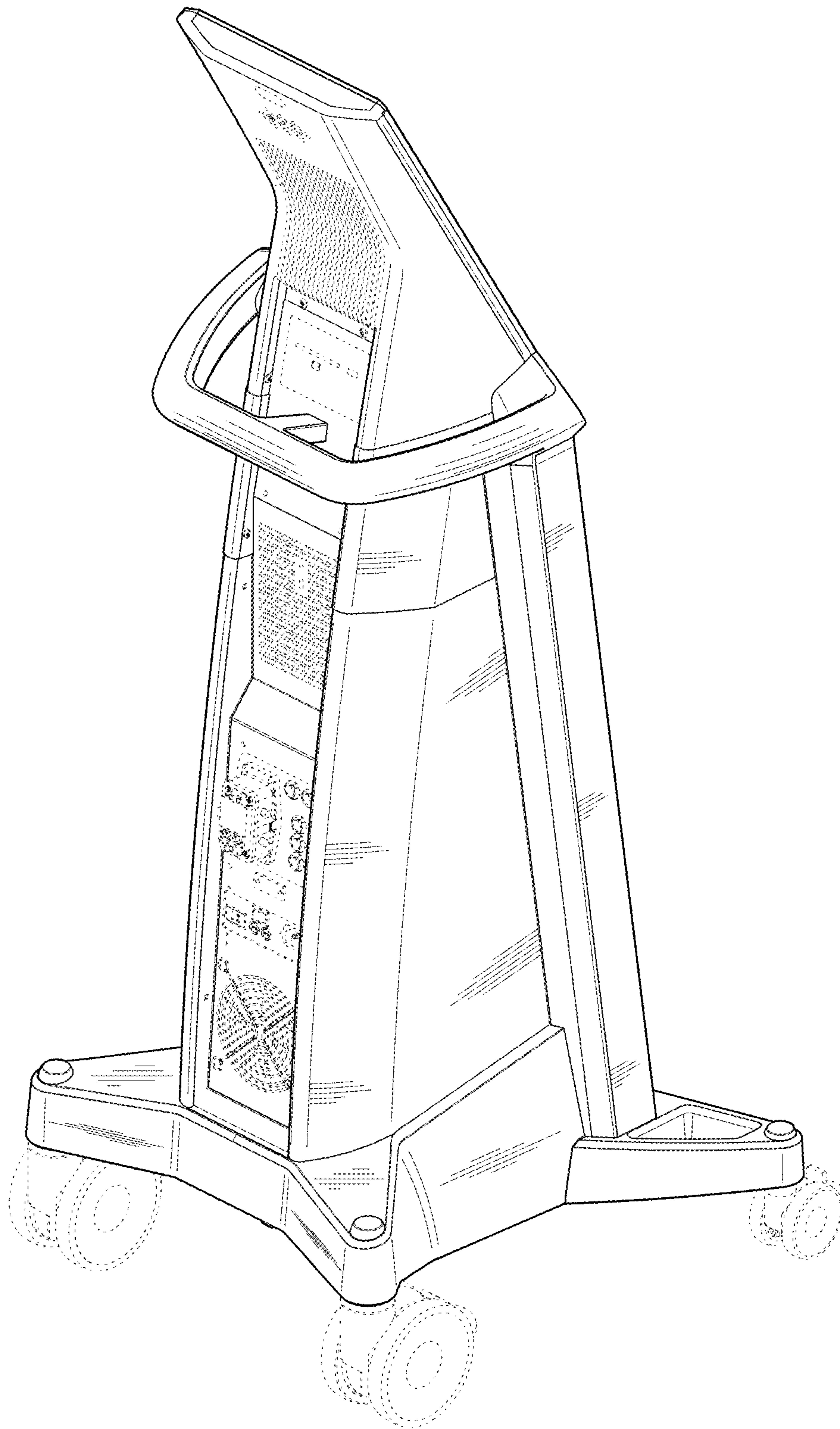

FIG. 2

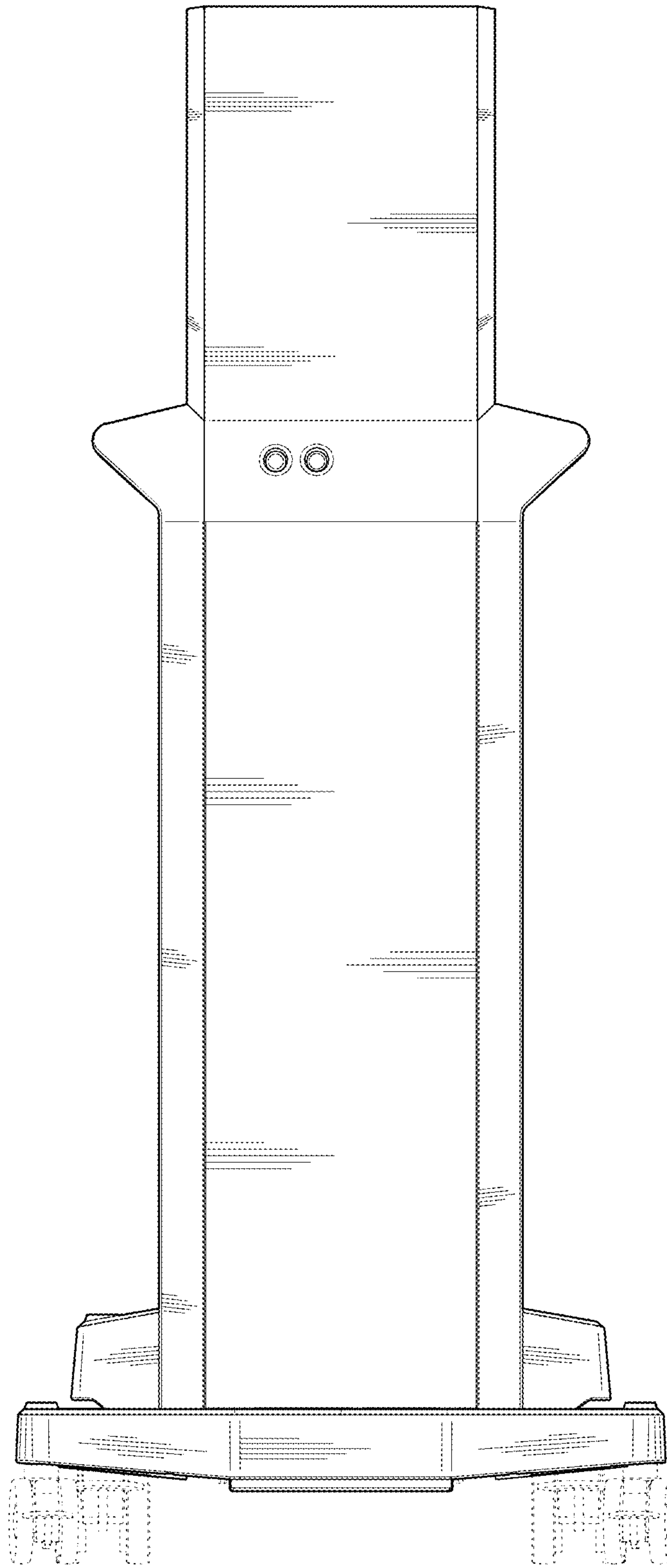

FIG. 3



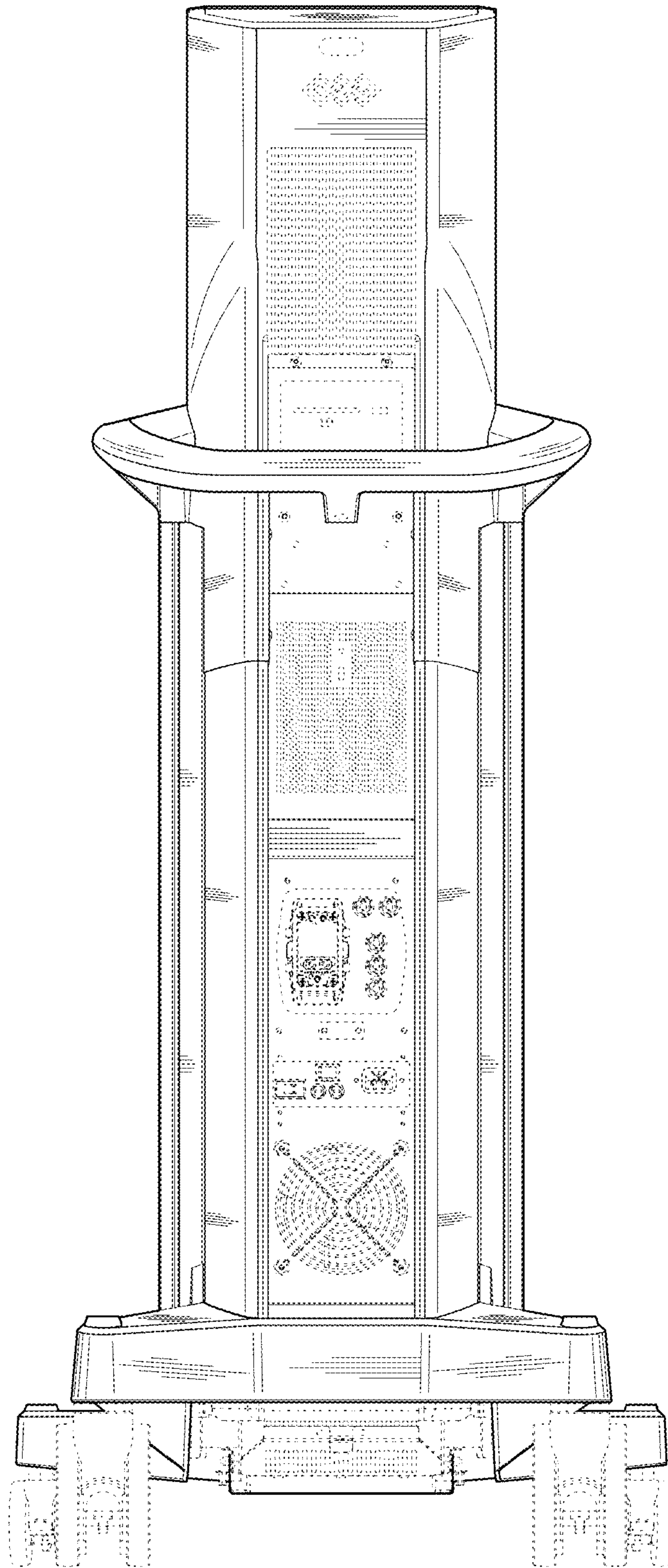

FIG. 4

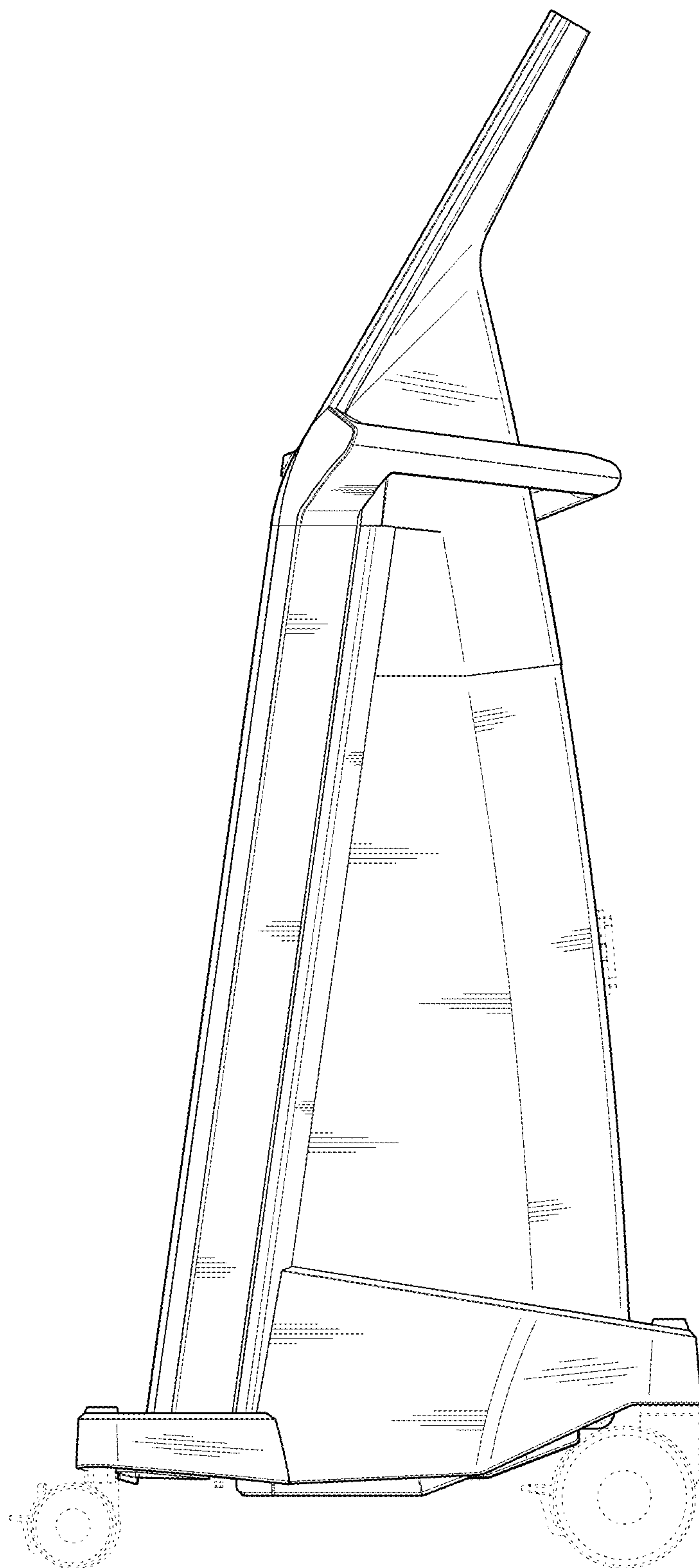

FIG. 5

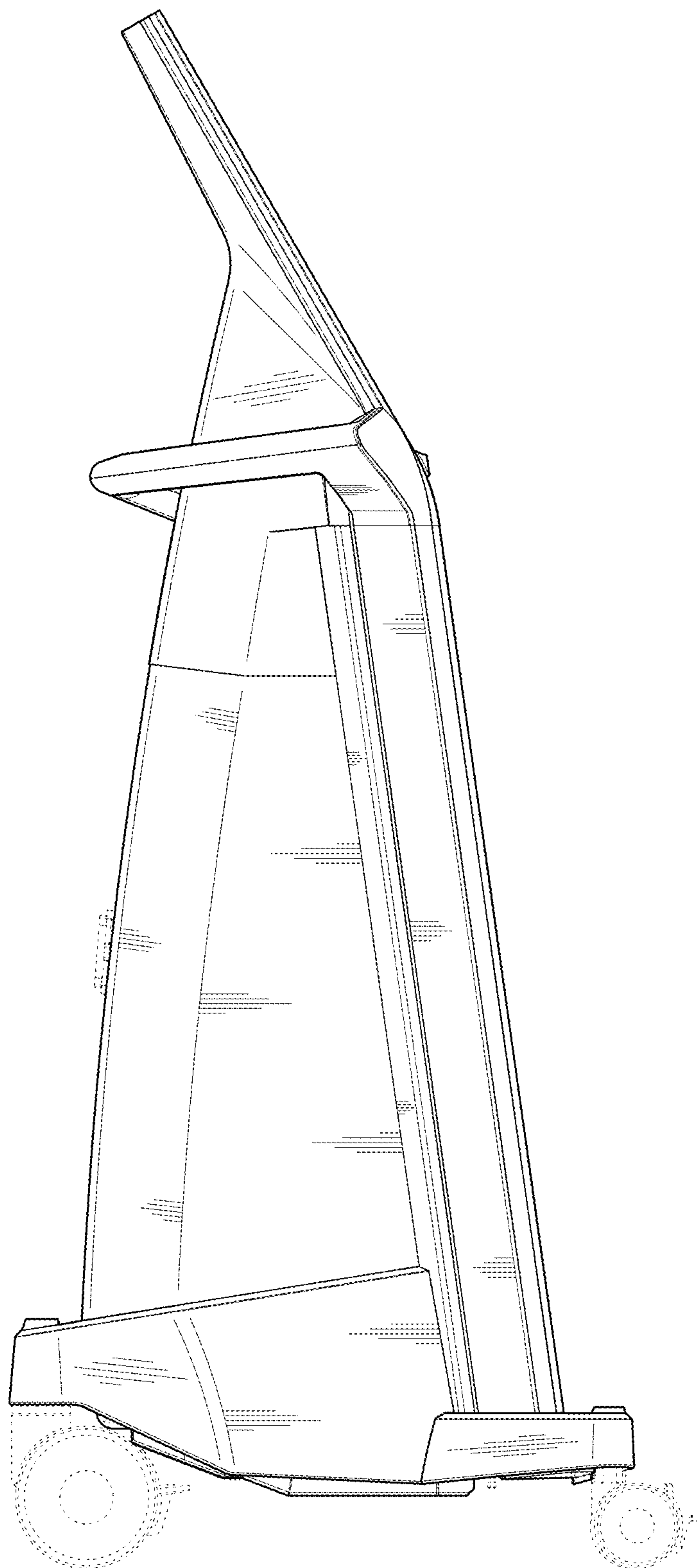

FIG. 6

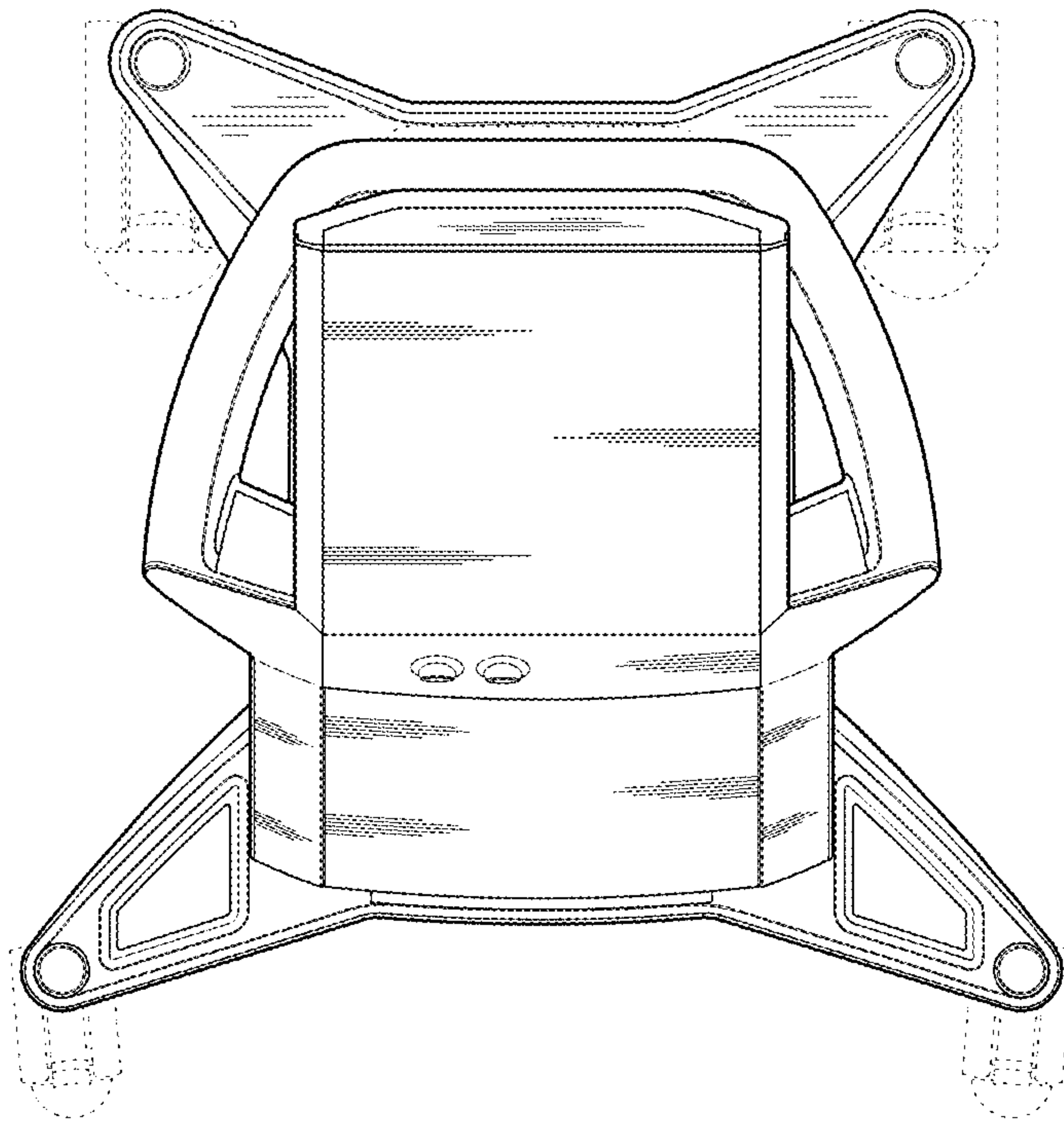

FIG. 7



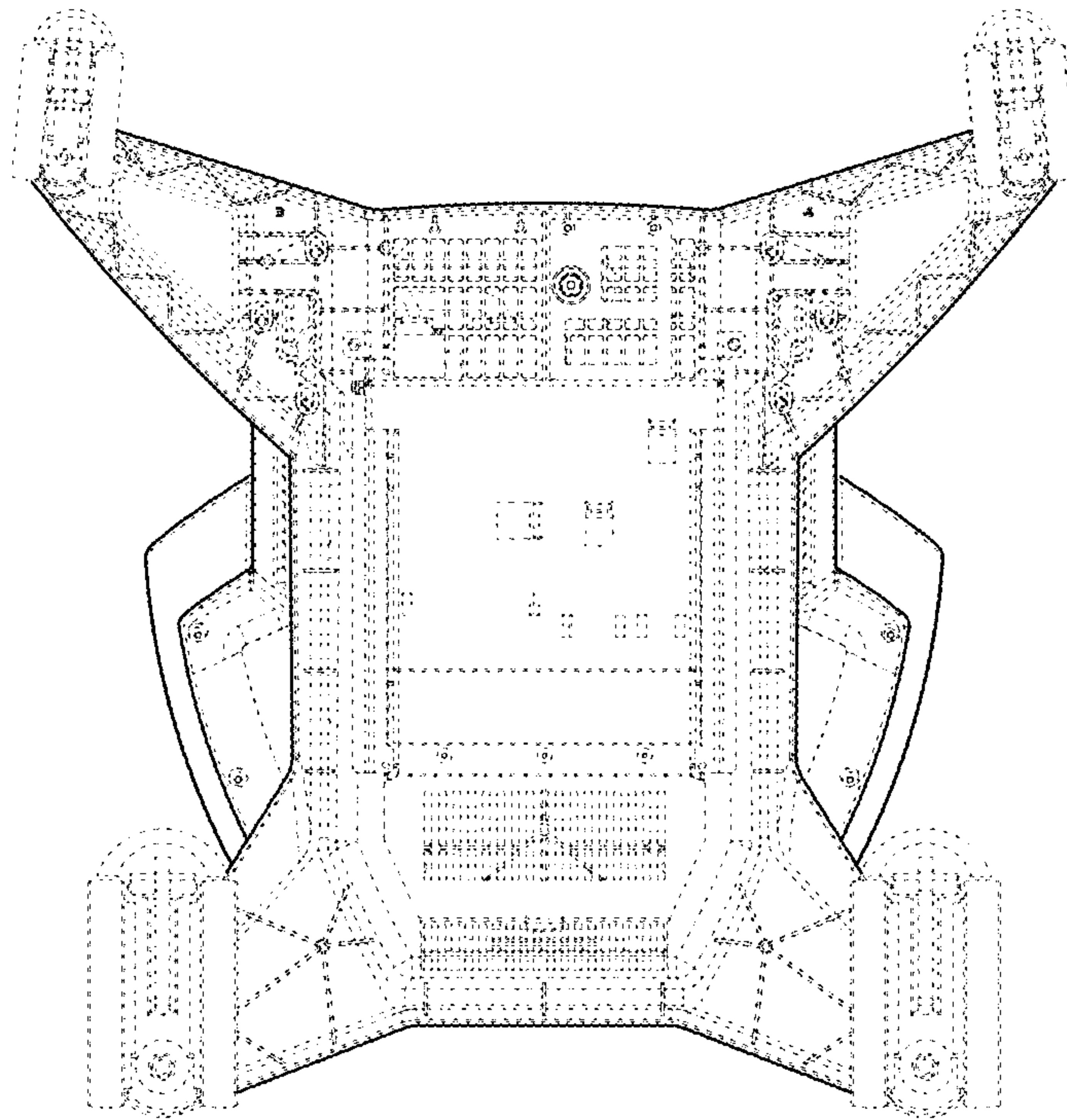

FIG. 8