



US00D873970S

(12) **United States Design Patent**
Park et al.

(10) **Patent No.:** **US D873,970 S**
(45) **Date of Patent:** **** Jan. 28, 2020**

- (54) **PROTECTIVE CAP FOR PIPE**
- (71) Applicant: **HUSTEEL CO., LTD.**, Seoul (KR)
- (72) Inventors: **In-Kyu Park**, Gyeonggi-do (KR); **Deug Sang Kwak**, Chungcheongnam-do (KR)
- (73) Assignee: **Husteel Co., Ltd.**, Seoul (KR)
- (**) Term: **15 Years**
- (21) Appl. No.: **29/645,427**
- (22) Filed: **Apr. 26, 2018**
- (30) **Foreign Application Priority Data**
 - Oct. 26, 2017 (KR) 30-2017-0049865
- (51) **LOC (12) Cl.** **23-01**
- (52) **U.S. Cl.**
USPC **D23/260**; D23/262
- (58) **Field of Classification Search**
USPC D23/259, 260, 209, 261, 303-304, 310,
D23/388; 4/178.22, 222.1,
4/255.01-255.12, 256.1, 286-289,
4/290-295, 309, 490, 507, 596, 652, 680;
220/203.1, 241, 780, 787, 789; D9/435,
D9/439, 453-454
CPC A47K 3/40
See application file for complete search history.

- (56) **References Cited**
U.S. PATENT DOCUMENTS
 - 3,525,366 A * 8/1970 Frees F16L 55/1152
138/109
 - 4,139,005 A * 2/1979 Dickey B65D 51/1638
137/74

D261,212 S *	10/1981	Mills	D7/700
D402,354 S *	12/1998	Strong	D23/259
D458,350 S *	6/2002	Wagner	D23/260
D570,966 S *	6/2008	Gilligan	D23/260
D678,481 S *	3/2013	Branco	D23/260
D717,405 S *	11/2014	Coronado	D23/259
D722,621 S *	2/2015	Gray	D15/28
D816,191 S *	4/2018	Cove	D23/259
D819,443 S *	6/2018	Martinez Carregui	D9/440
D834,685 S *	11/2018	Gerger	D23/261
2011/0127358 A1 *	6/2011	Nease	B05B 1/044 239/722

* cited by examiner

Primary Examiner — Amy C Wierenga
(74) *Attorney, Agent, or Firm* — Akerman LLP

(57) **CLAIM**

We claim the ornamental design for protective cap for pipe, as shown and described.

DESCRIPTION

FIG. 1 is a perspective view of the protective cap for pipe, showing our new, original and ornamental design;
FIG. 2 is a front view thereof;
FIG. 3 is a rear view thereof;
FIG. 4 is a left side view thereof;
FIG. 5 is a right side view thereof;
FIG. 6 is a top view thereof; and,
FIG. 7 is a bottom view thereof.
The broken lines depict portions of the protective cap for pipe that form no part of the claim.

1 Claim, 7 Drawing Sheets

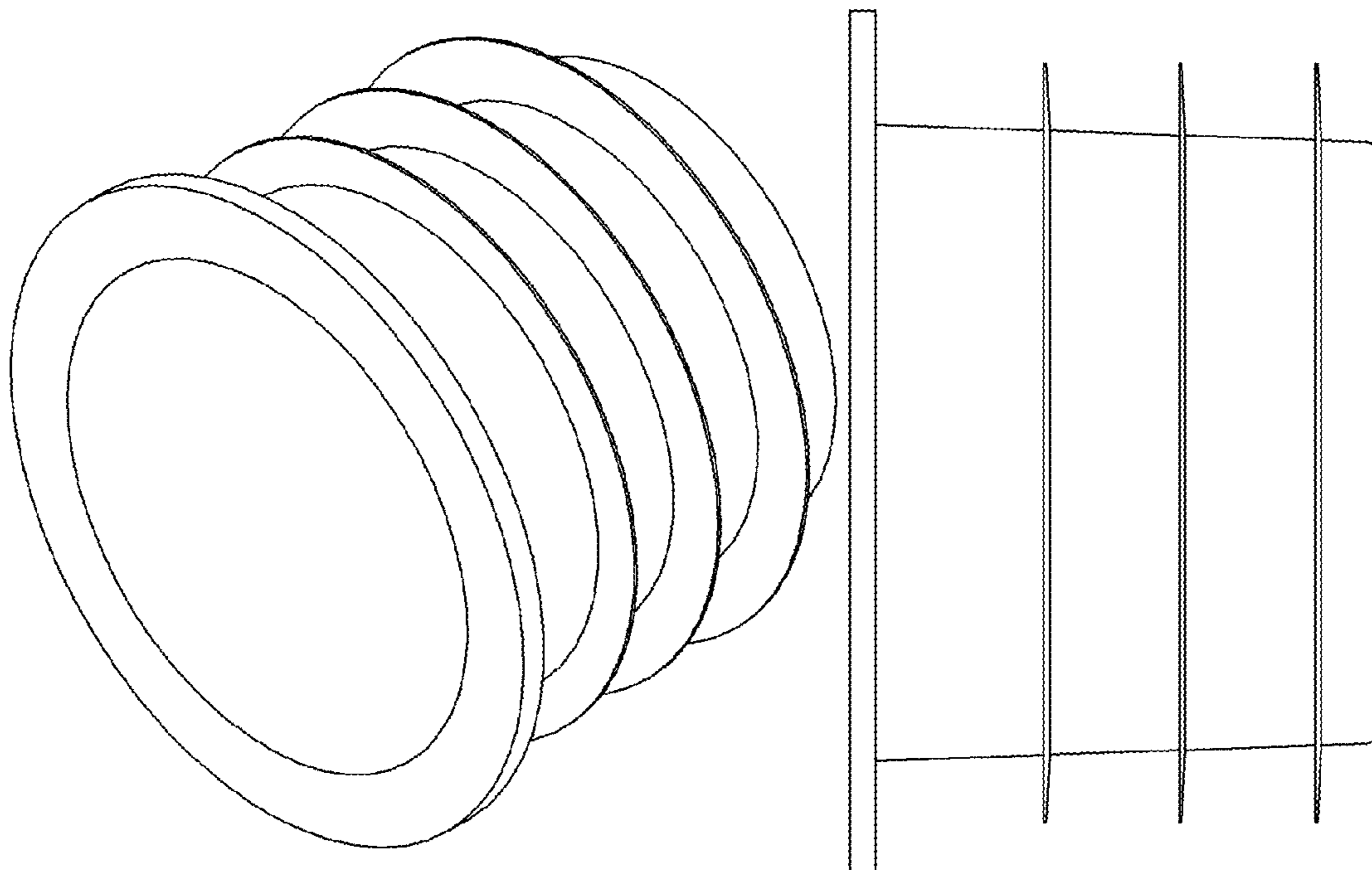

FIG. 1

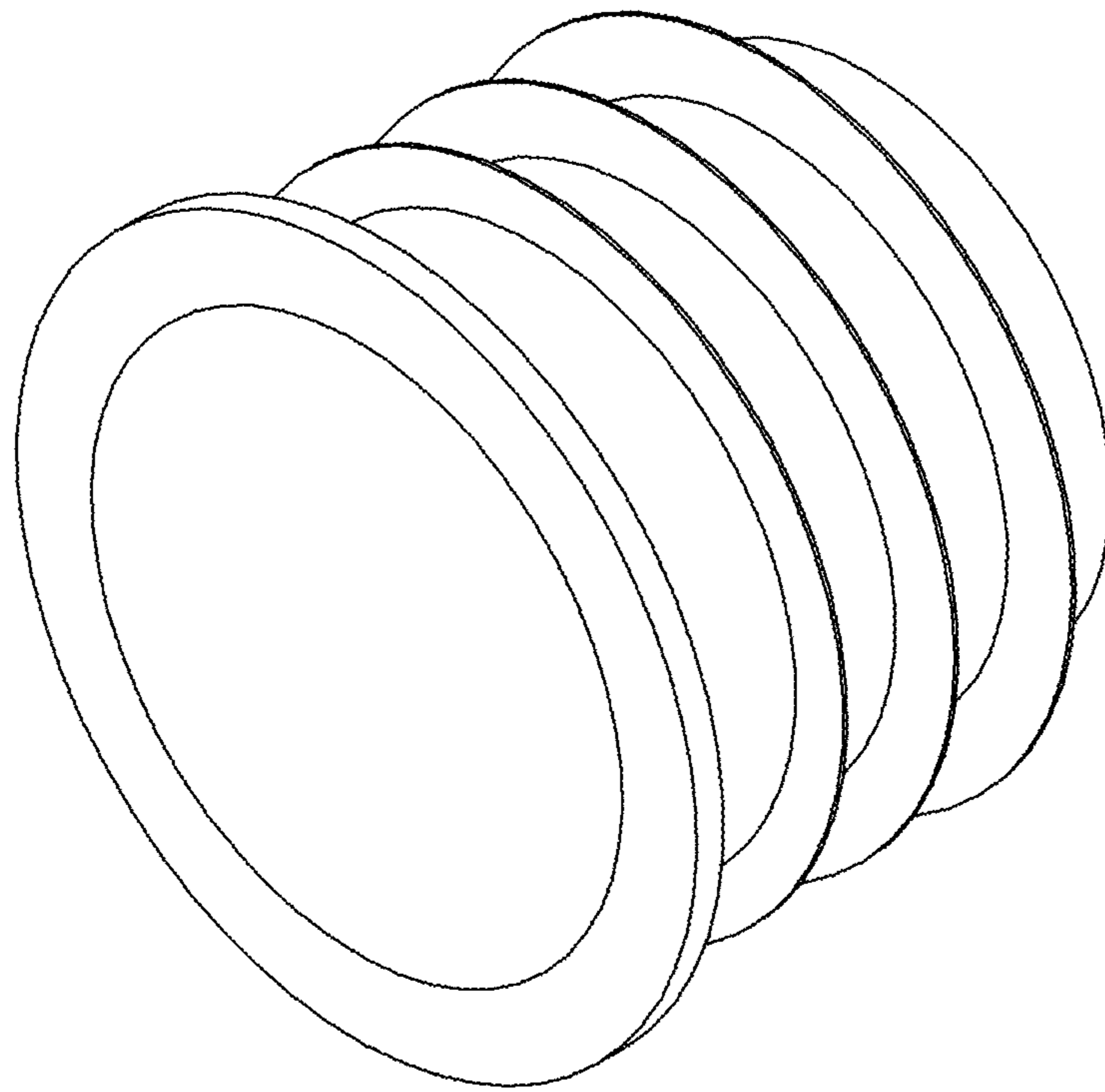

FIG. 2

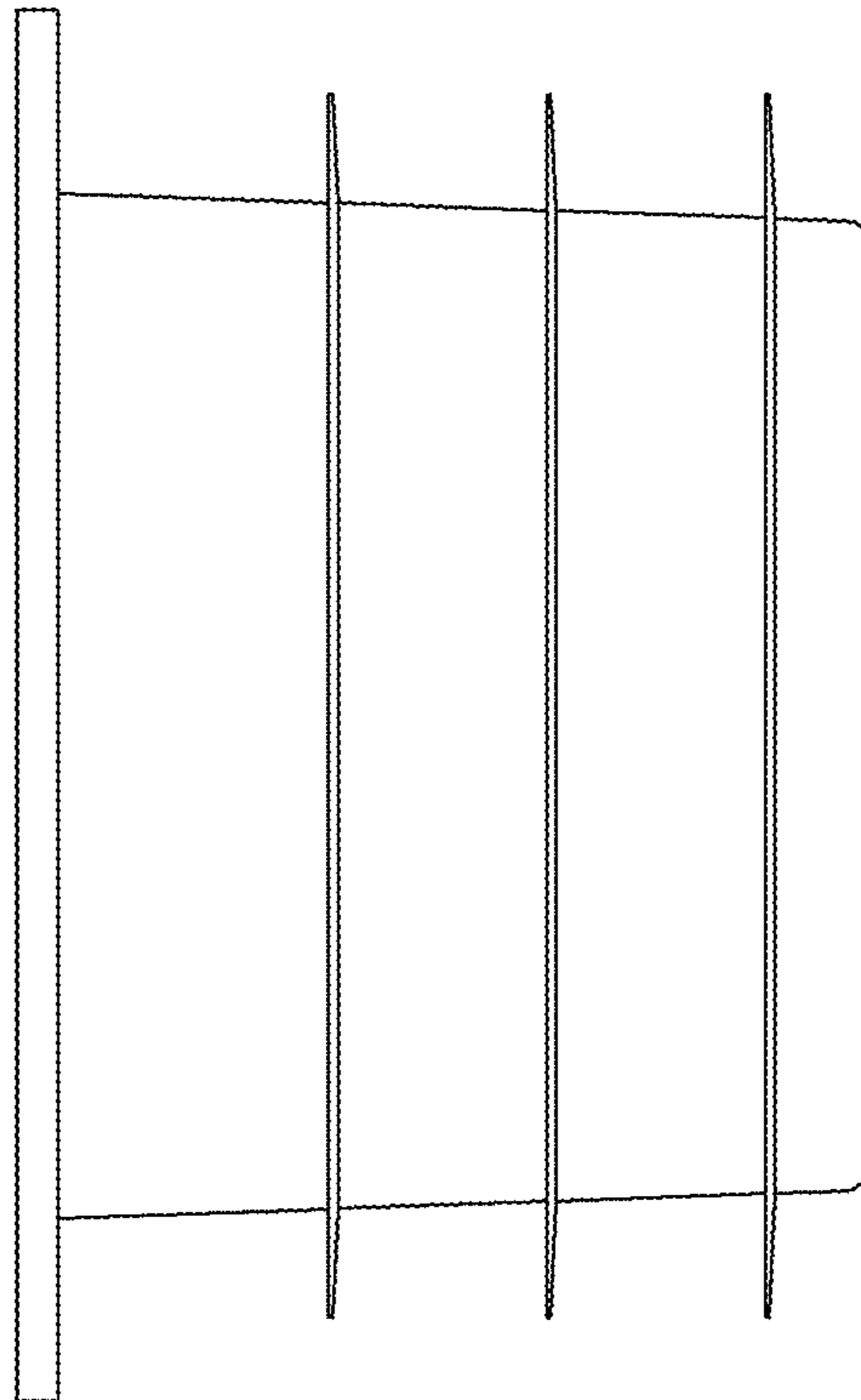

FIG. 3

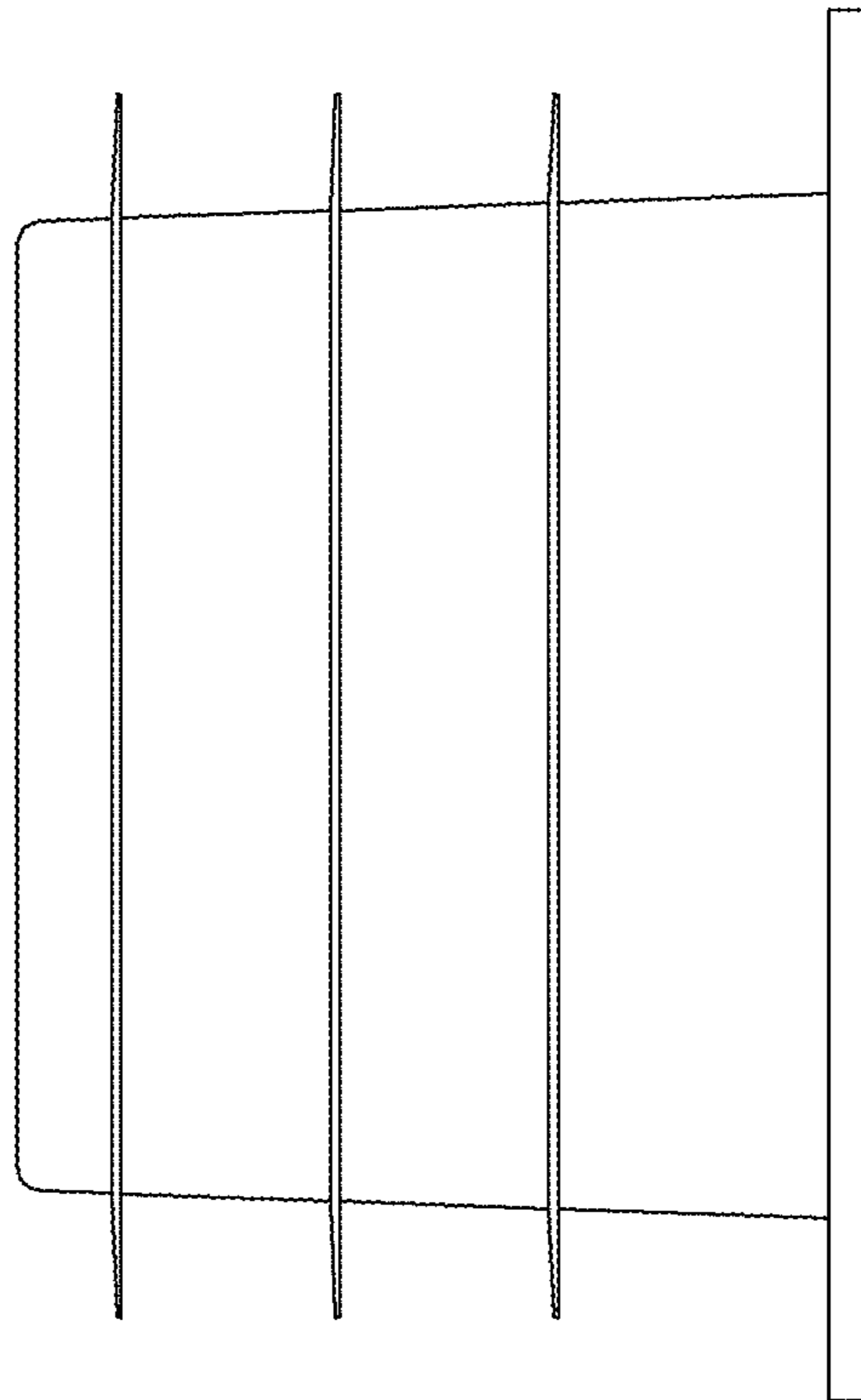

FIG. 4

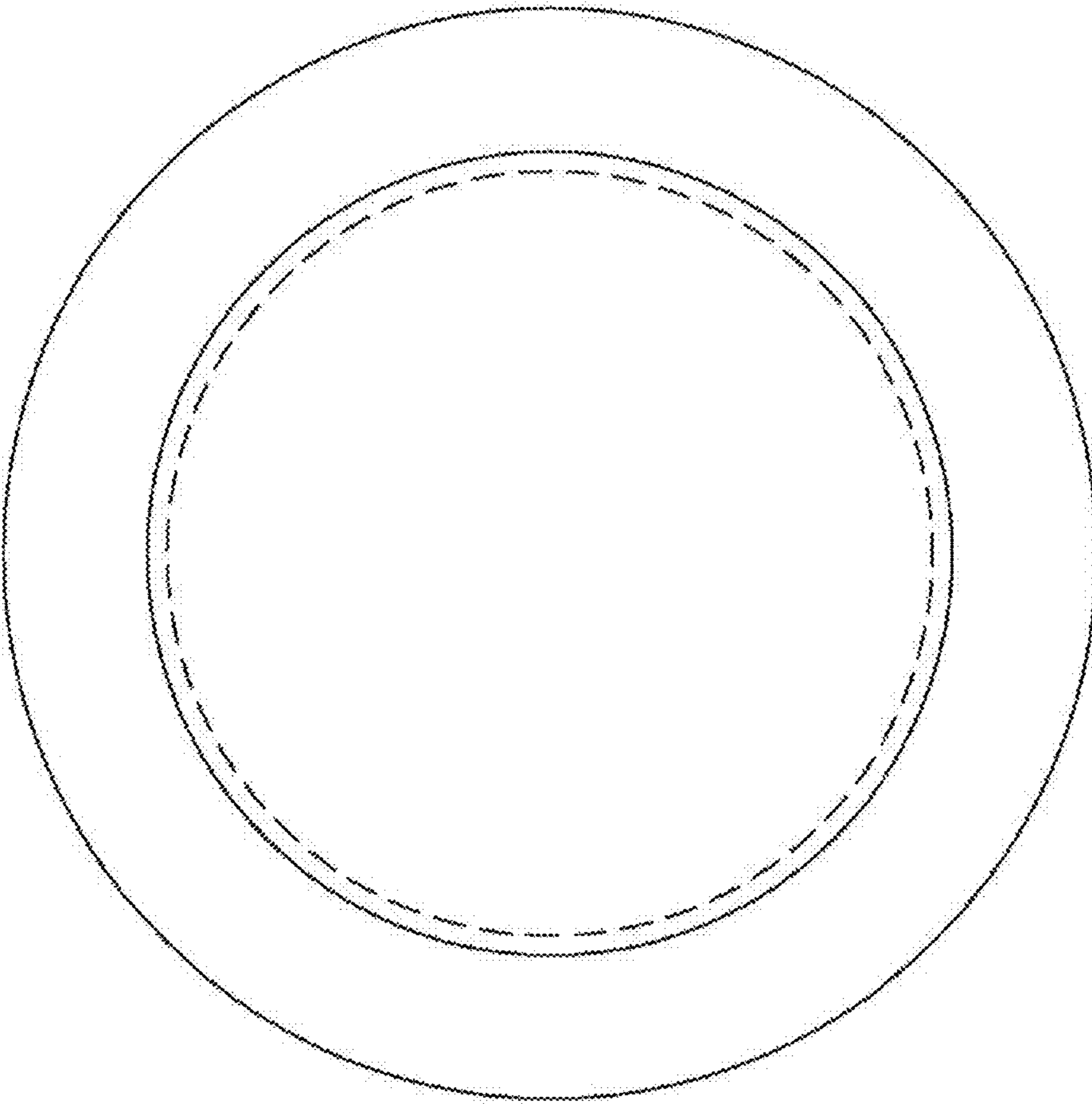

FIG. 5

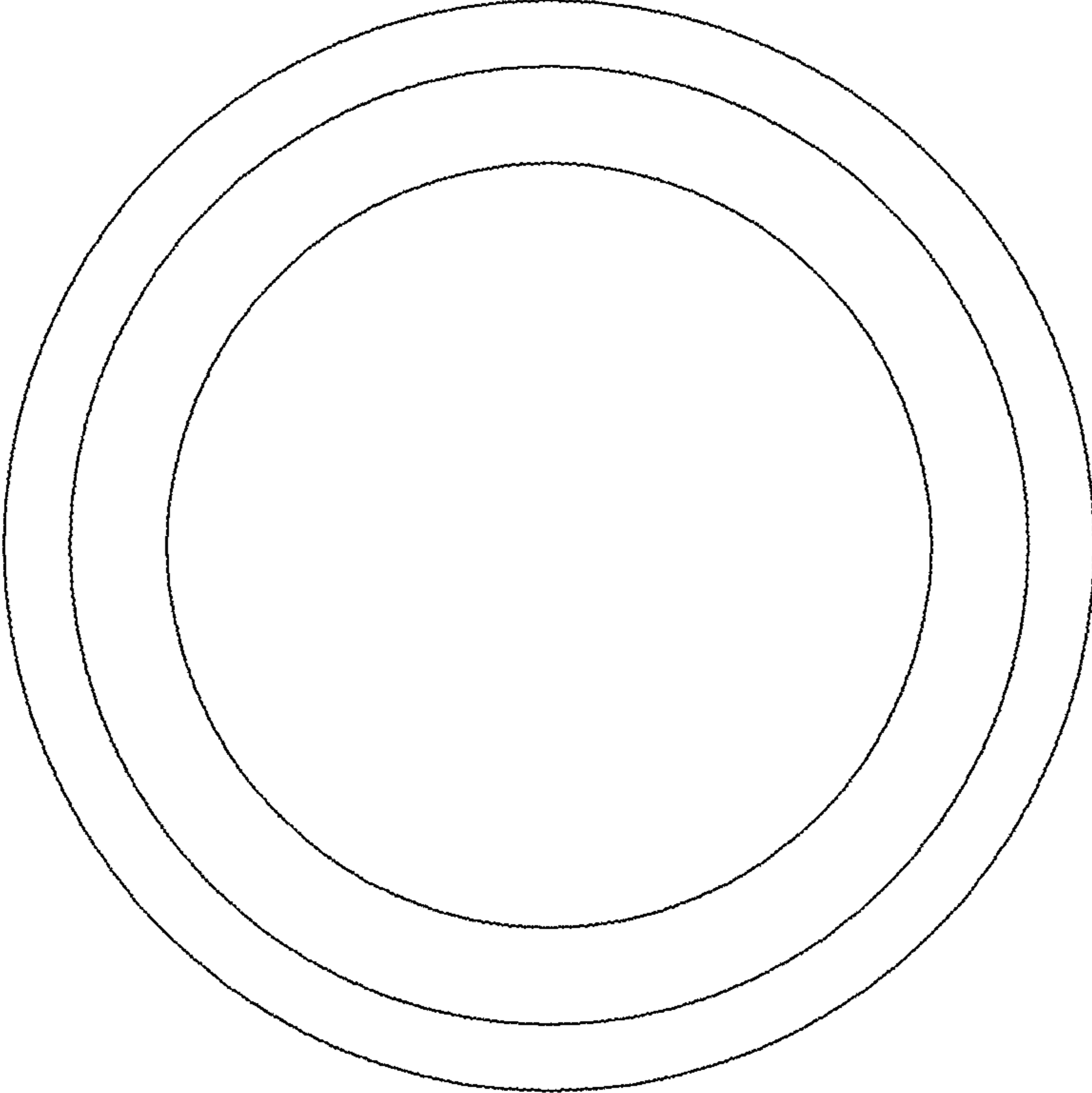

FIG. 6

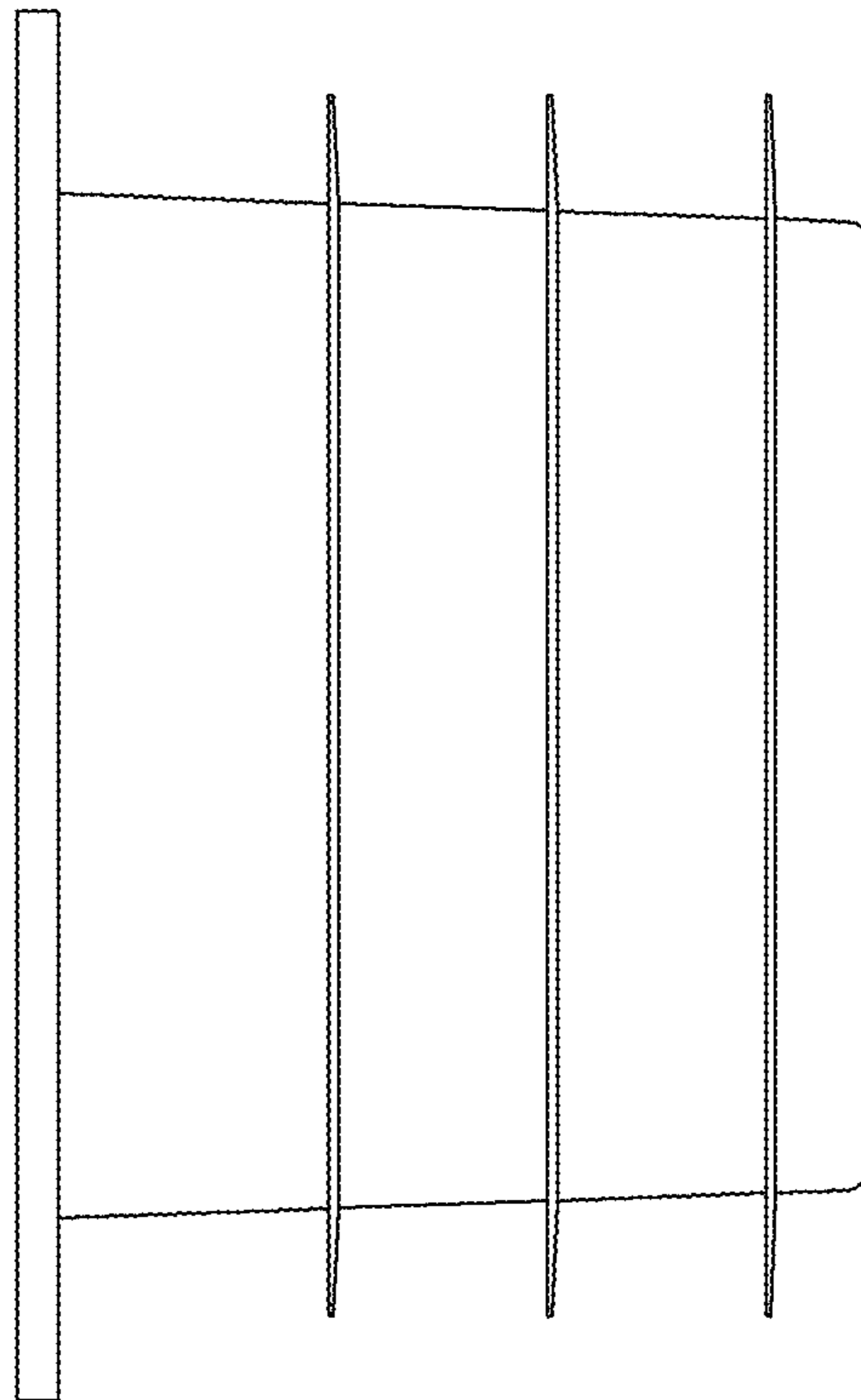

FIG. 7

