



US00D873965S

(12) **United States Design Patent**
Lazarini

(10) **Patent No.:** **US D873,965 S**
(45) **Date of Patent:** **** Jan. 28, 2020**

(54) **FAUCET**

(71) Applicant: **DELTA FAUCET COMPANY,**
Indianapolis, IN (US)

(72) Inventor: **Alejandra Lazarini,** Carmel, IN (US)

(73) Assignee: **DELTA FAUCET COMPANY,**
Indianapolis, IN (US)

(**) Term: **15 Years**

(21) Appl. No.: **29/642,884**

(22) Filed: **Apr. 3, 2018**

(51) **LOC (12) Cl.** **23-01**

(52) **U.S. Cl.**
USPC **D23/241**

(58) **Field of Classification Search**
USPC D23/238–243, 249–252, 254–255, 257;
D8/307–308
CPC Y10T 137/9464
See application file for complete search history.

(56) **References Cited**

U.S. PATENT DOCUMENTS

D519,610 S * 4/2006 Fritz D23/241
D578,614 S * 10/2008 Fritz D23/241

D667,934 S * 9/2012 Liao D23/242
D680,193 S * 4/2013 Kwok D23/242
D754,297 S * 4/2016 Garland D23/242
D796,638 S * 9/2017 Liao D23/242
D797,893 S * 9/2017 Fritz D23/242
D822,171 S * 7/2018 Bennett D23/242
D839,390 S * 1/2019 Eads D23/242

* cited by examiner

Primary Examiner — Amy C Wierenga

(74) *Attorney, Agent, or Firm* — Edgar A. Zarins; Nirav D. Parikh

(57) **CLAIM**

The ornamental design for a faucet, as shown and described.

DESCRIPTION

FIG. 1 is a first perspective view of a faucet showing my new design;
FIG. 2 is a second perspective view thereof;
FIG. 3 is a front elevational view thereof;
FIG. 4 is a left side view thereof;
FIG. 5 is a rear view thereof;
FIG. 6 is a right side view thereof; and,
FIG. 7 is a top plan view thereof.

1 Claim, 4 Drawing Sheets

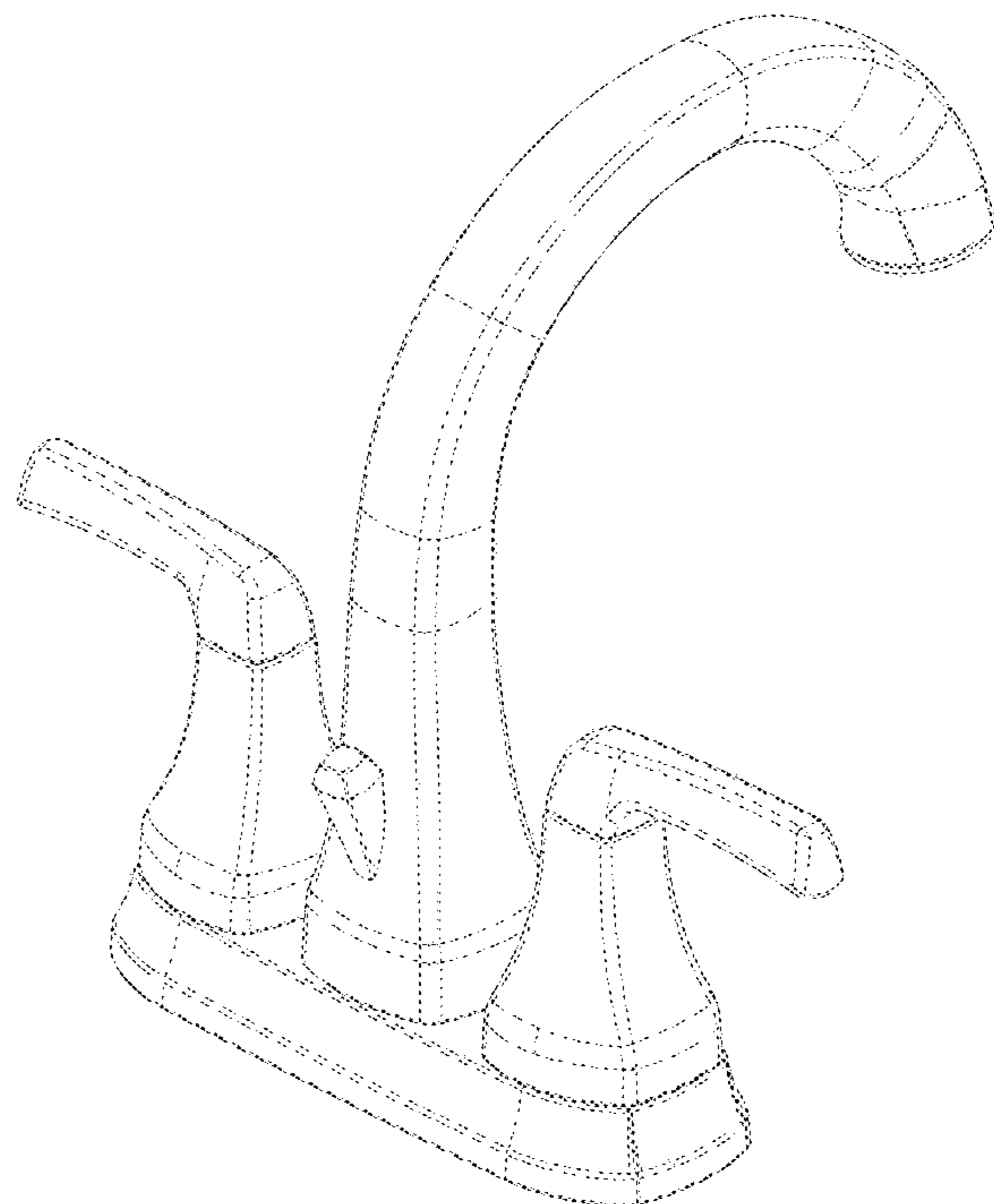
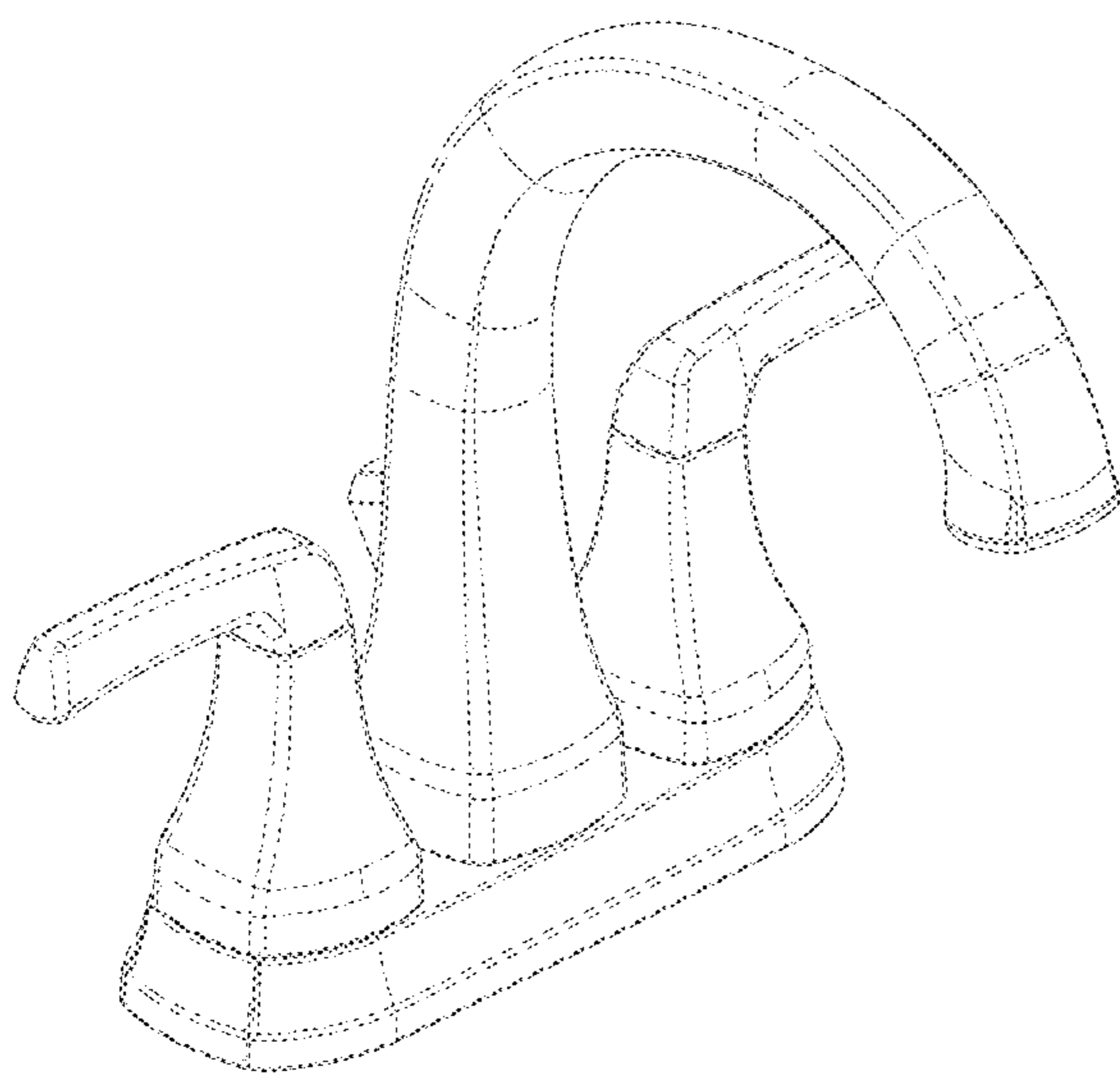

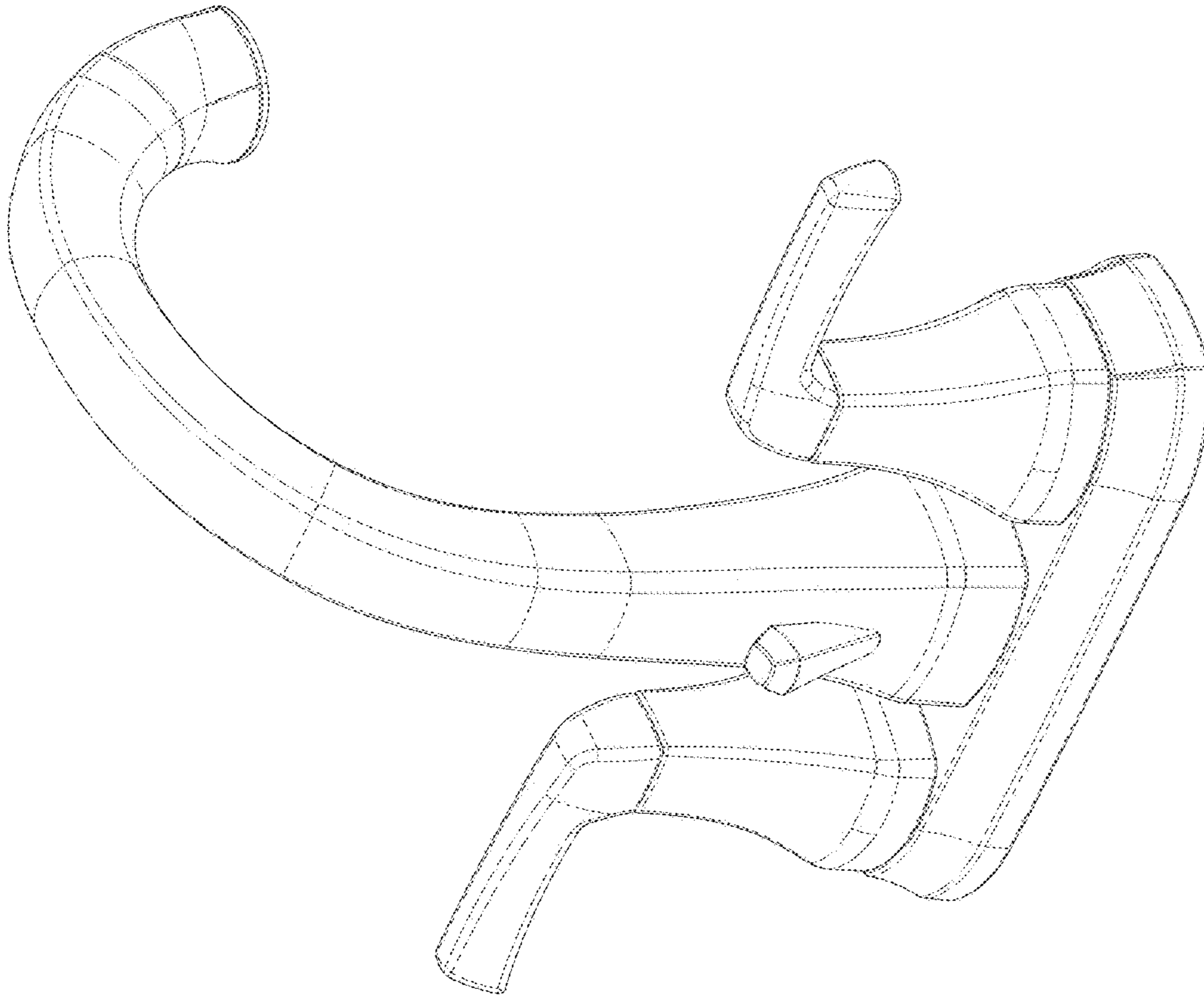

FIG - 1

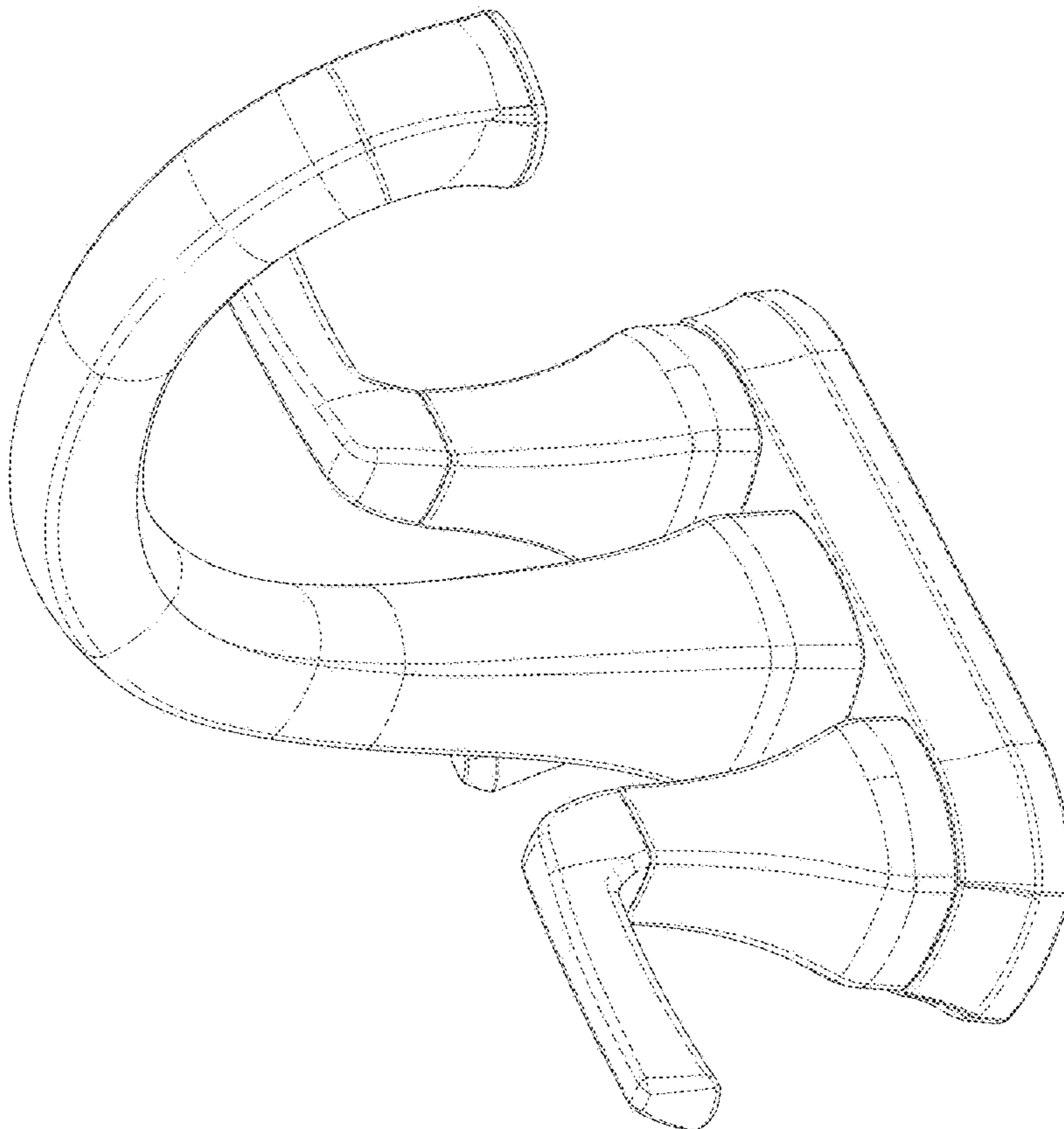

FIG - 2

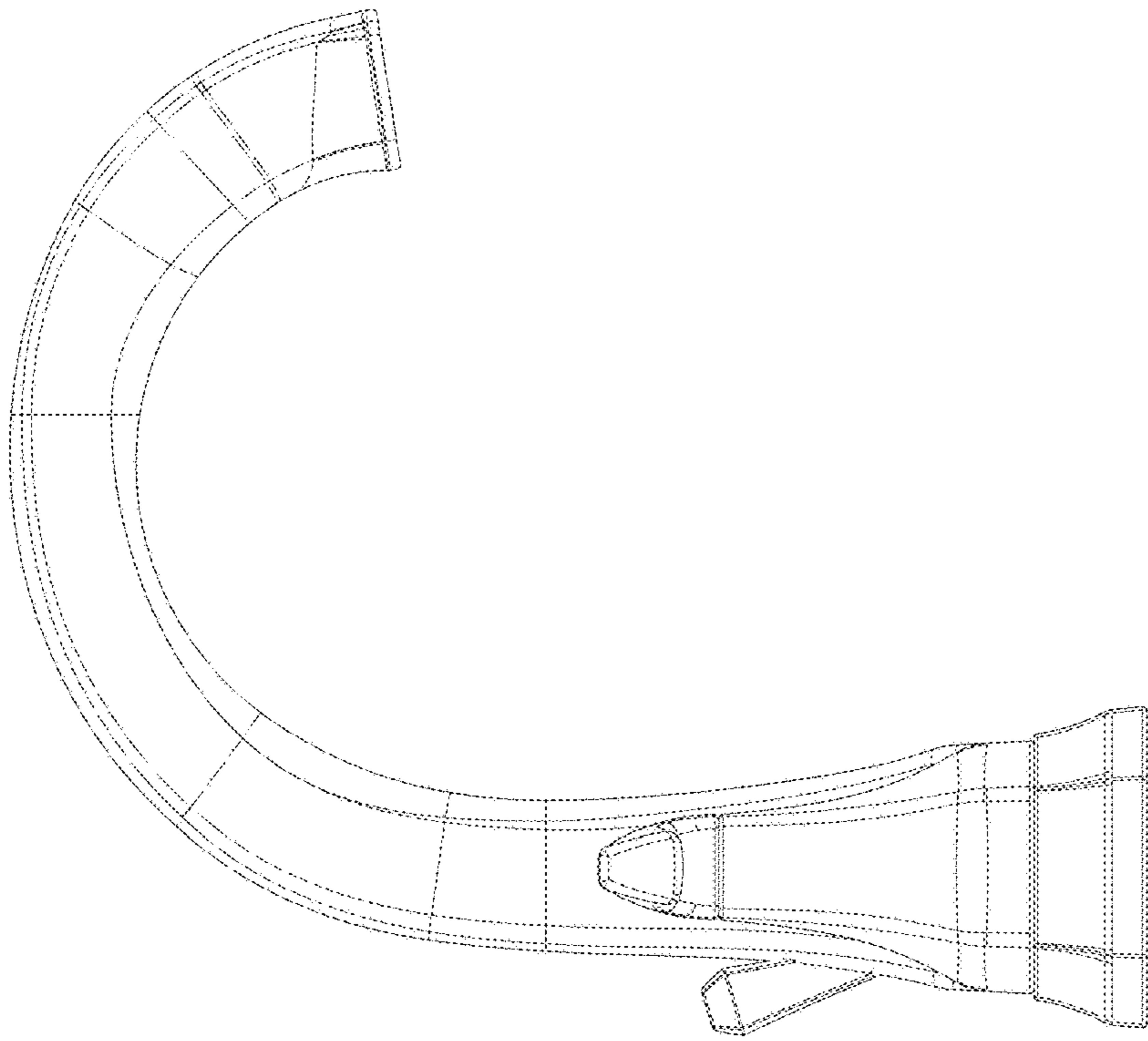

FIG - 4

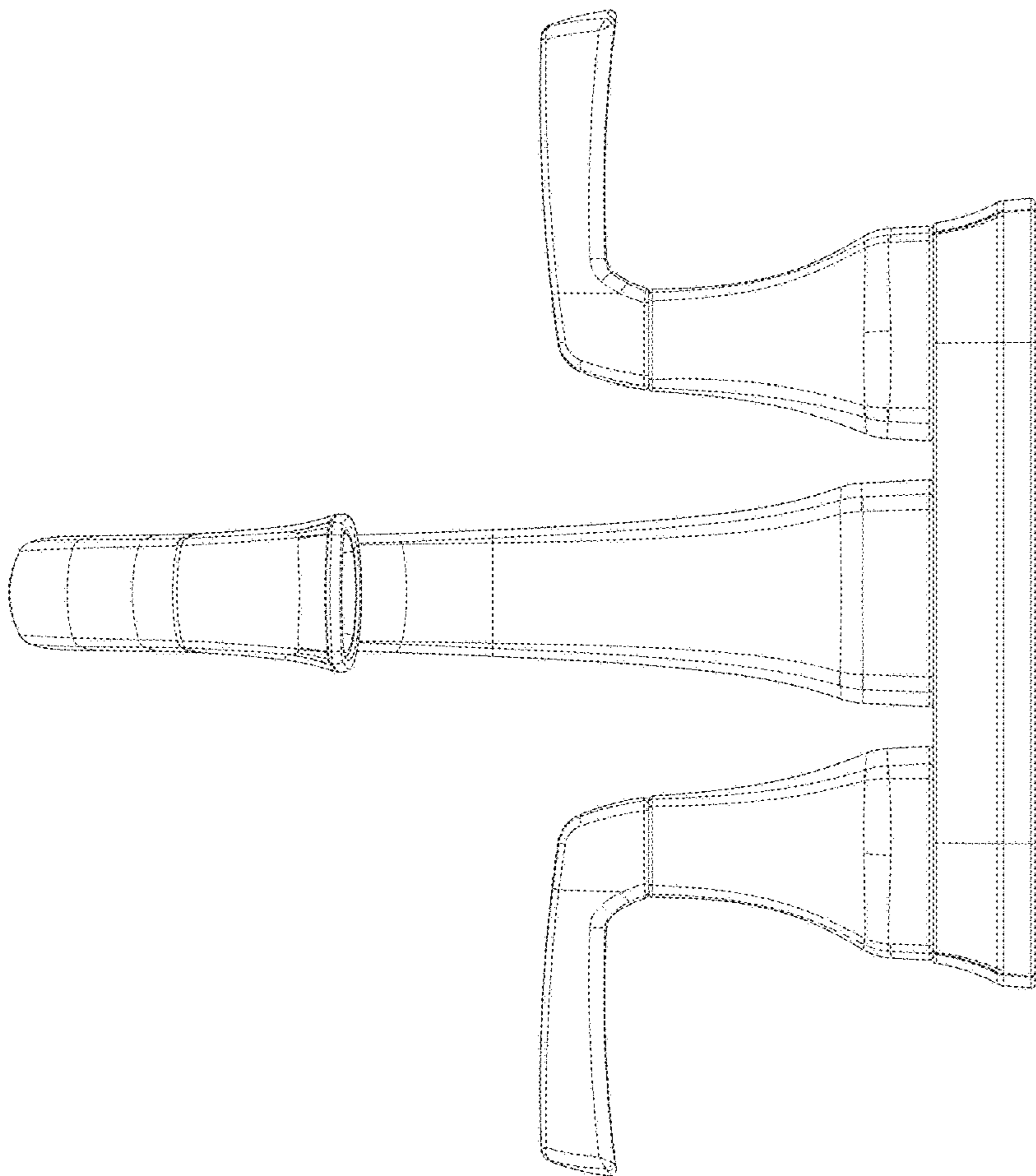

FIG - 3

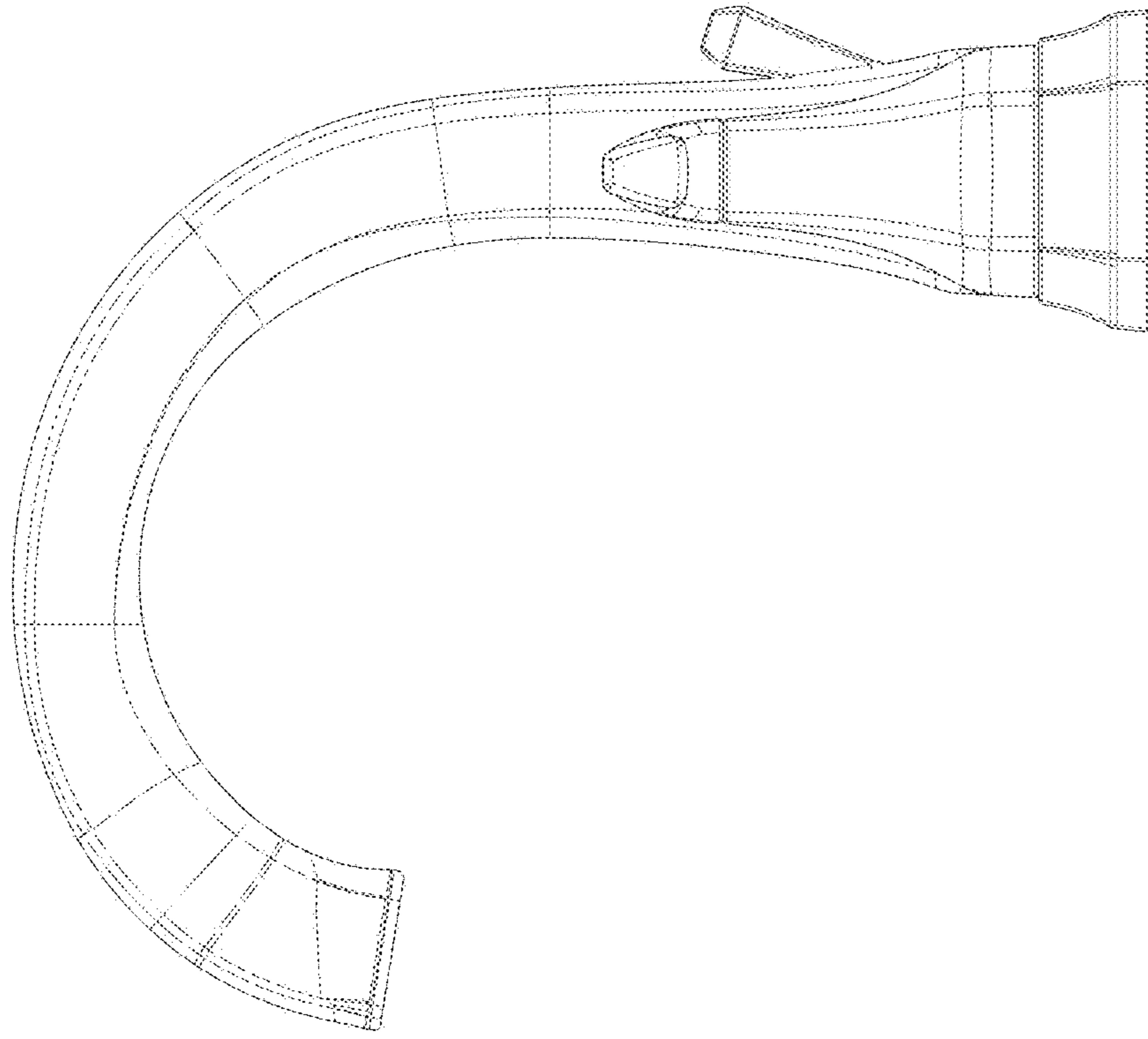

FIG - 6

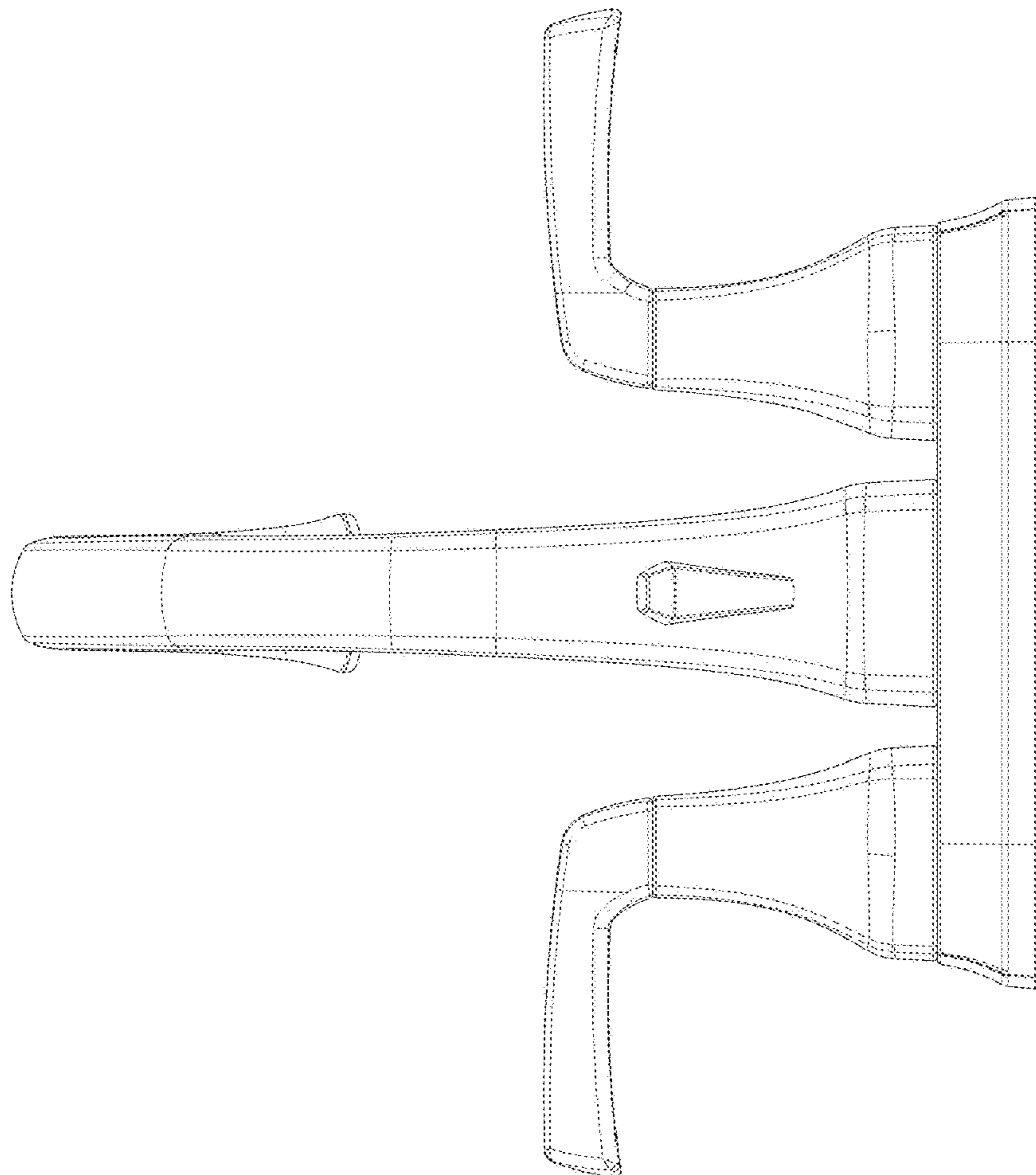

FIG - 5

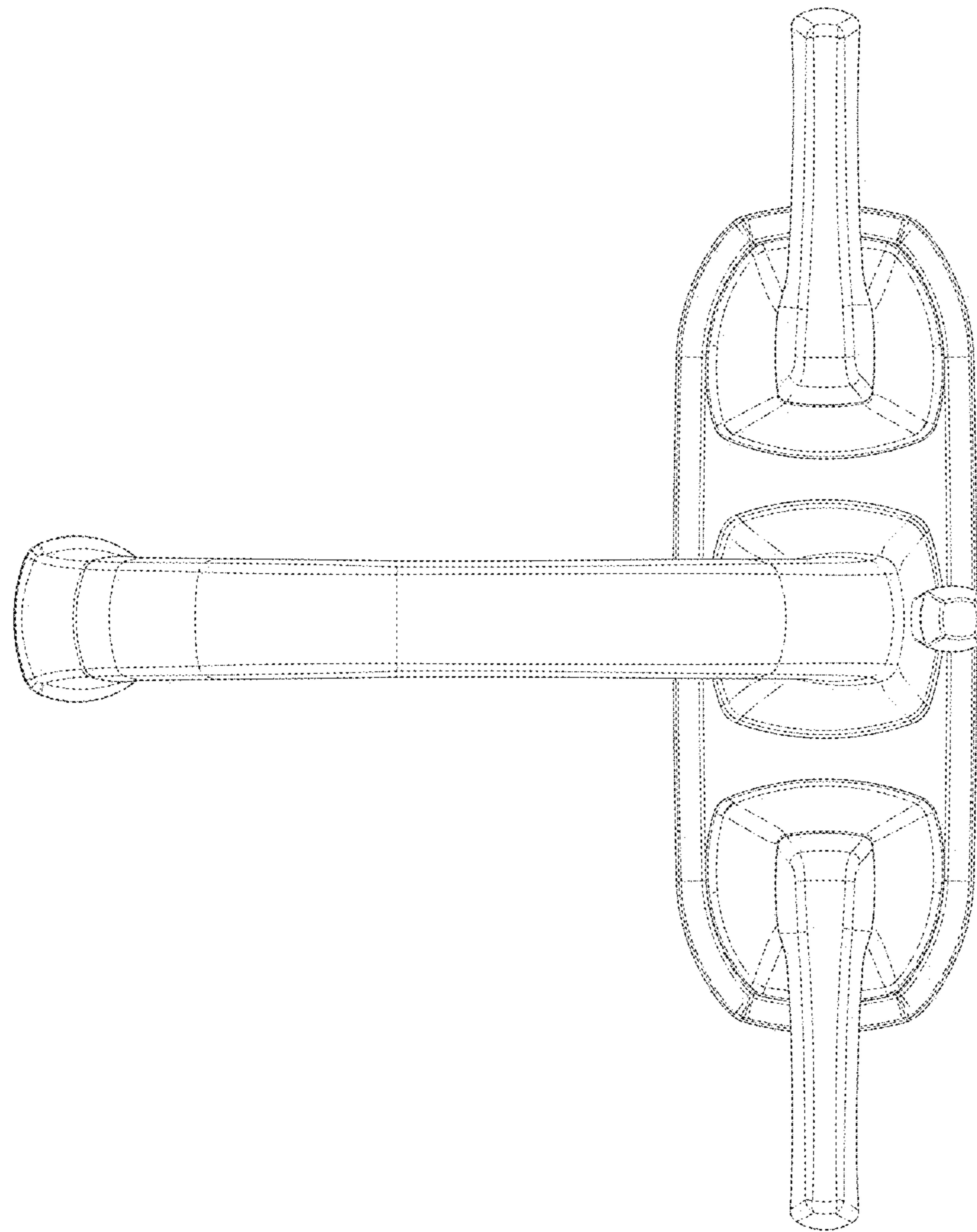

FIG - 7