



US00D873896S

(12) **United States Design Patent** (10) **Patent No.:** **US D873,896 S**
Hokari (45) **Date of Patent:** **** Jan. 28, 2020**

(54) **BATTERY FOR DIGITAL CAMERA**

(71) Applicant: **CANON KABUSHIKI KAISHA,**
Tokyo (JP)

(72) Inventor: **Yusuke Hokari,** Tokyo (JP)

(**) Term: **15 Years**

(21) Appl. No.: **35/505,543**

(22) Filed: **Feb. 21, 2018**

(80) **Hague Agreement Data**

Int. Filing Date: **Feb. 21, 2018**

Int. Reg. No.: **DM/101188**

Int. Reg. Date: **Feb. 21, 2018**

Int. Reg. Pub. Date: **Aug. 24, 2018**

(30) **Foreign Application Priority Data**

Aug. 25, 2017 (JP) 2017-018300
 Aug. 25, 2017 (JP) 2017-018301
 Aug. 25, 2017 (JP) 2017-018302
 Aug. 25, 2017 (JP) 2017-018303

(51) **LOC (12) Cl.** **16-05**

(52) **U.S. Cl.**
USPC **D16/237**

(58) **Field of Classification Search**
CPC H04N 5/335; H04N 5/225
See application file for complete search history.

(56) **References Cited**

U.S. PATENT DOCUMENTS

D343,853 S * 2/1994 Haung D16/245
 D346,583 S * 5/1994 Mohri D13/108

D478,608 S * 8/2003 Briks D13/103
 D489,748 S * 5/2004 McKay D13/168
 D503,185 S * 3/2005 Haga D16/242
 D515,614 S * 2/2006 Speggorin F16M 11/14
 D16/243
 D552,659 S * 10/2007 Stephens D16/237
 D556,680 S * 12/2007 Matsumoto D13/103
 D560,159 S * 1/2008 Matsumoto D13/103
 D647,943 S * 11/2011 Jannard D13/103
 D647,944 S * 11/2011 Jannard D13/103
 D677,708 S * 3/2013 Zhan D16/239
 D842,359 S * 3/2019 Imai D16/237
 D857,081 S * 8/2019 Kuwabara D16/237
 2009/0122169 A1 * 5/2009 Agan H04N 5/2251
 348/294

* cited by examiner

Primary Examiner — Holly E Thurman

(57) **CLAIM**

The ornamental design for a battery for digital camera, as shown and described.

DESCRIPTION

- 1. Battery for digital camera
- 1.1 : Front
- 1.2 : Back
- 1.3 : Top
- 1.4 : Bottom
- 1.5 : Left
- 1.6 : Right
- 1.7 : Perspective

1 Claim, 7 Drawing Sheets

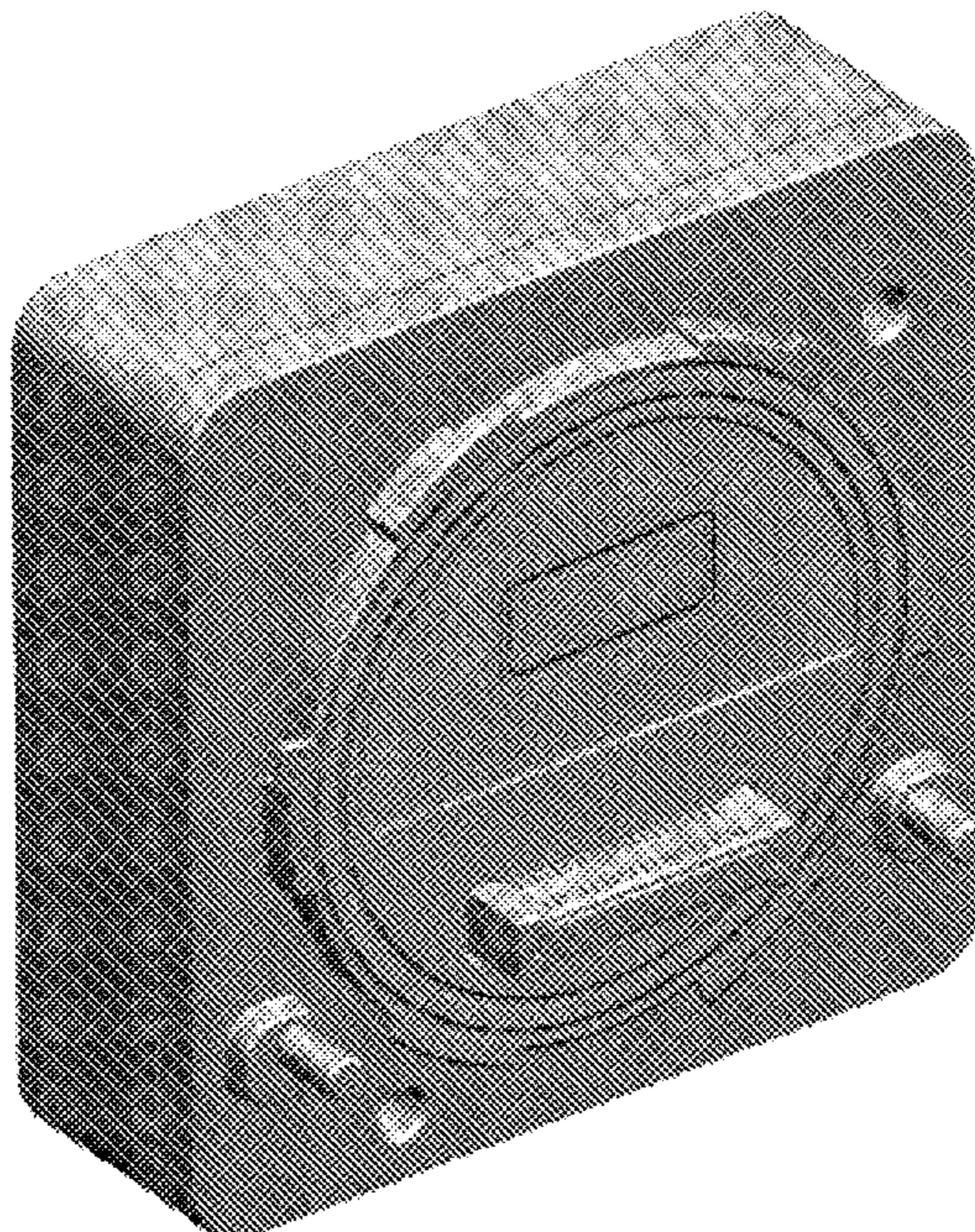

1.1

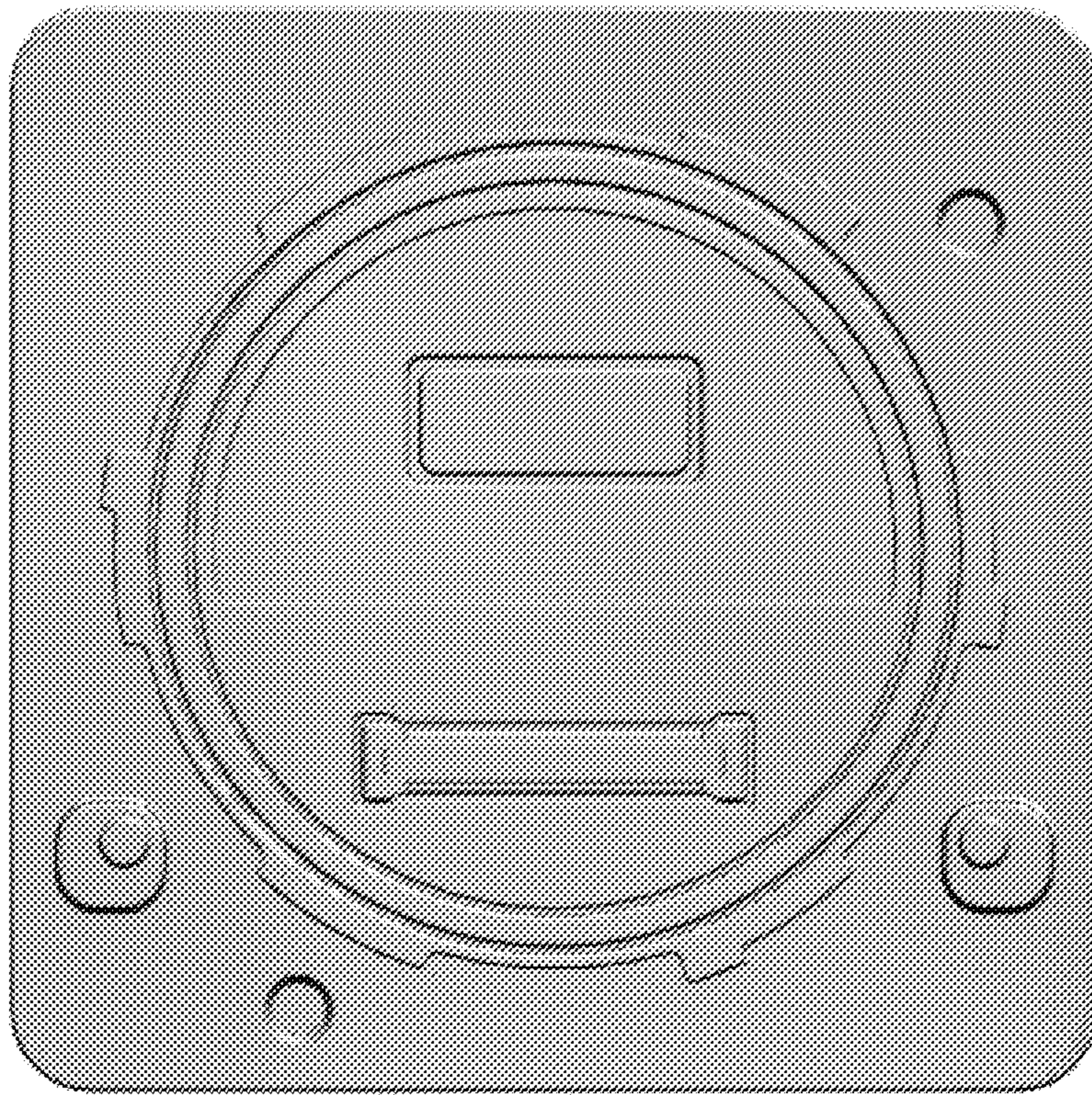

1.2

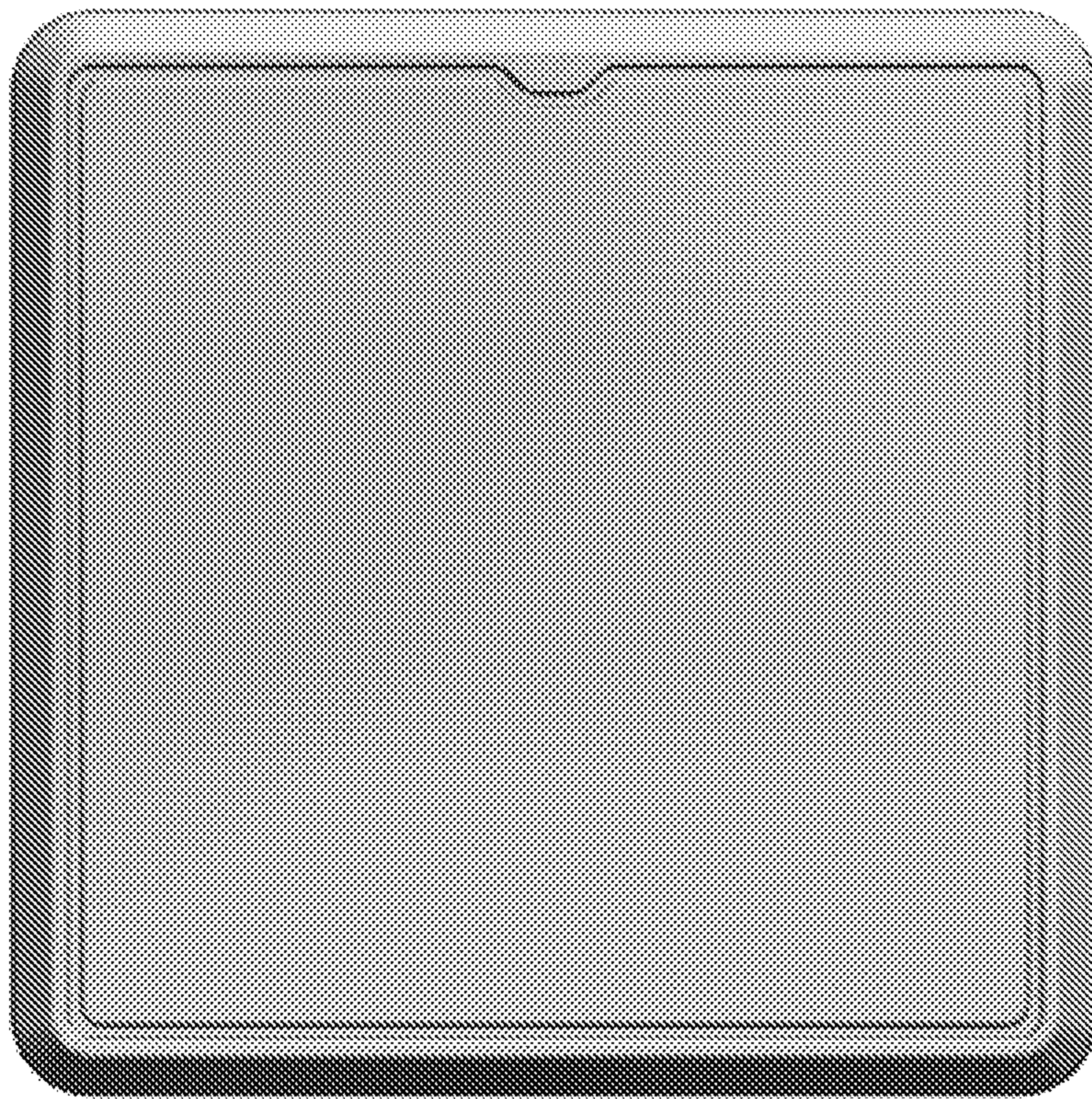

1.3

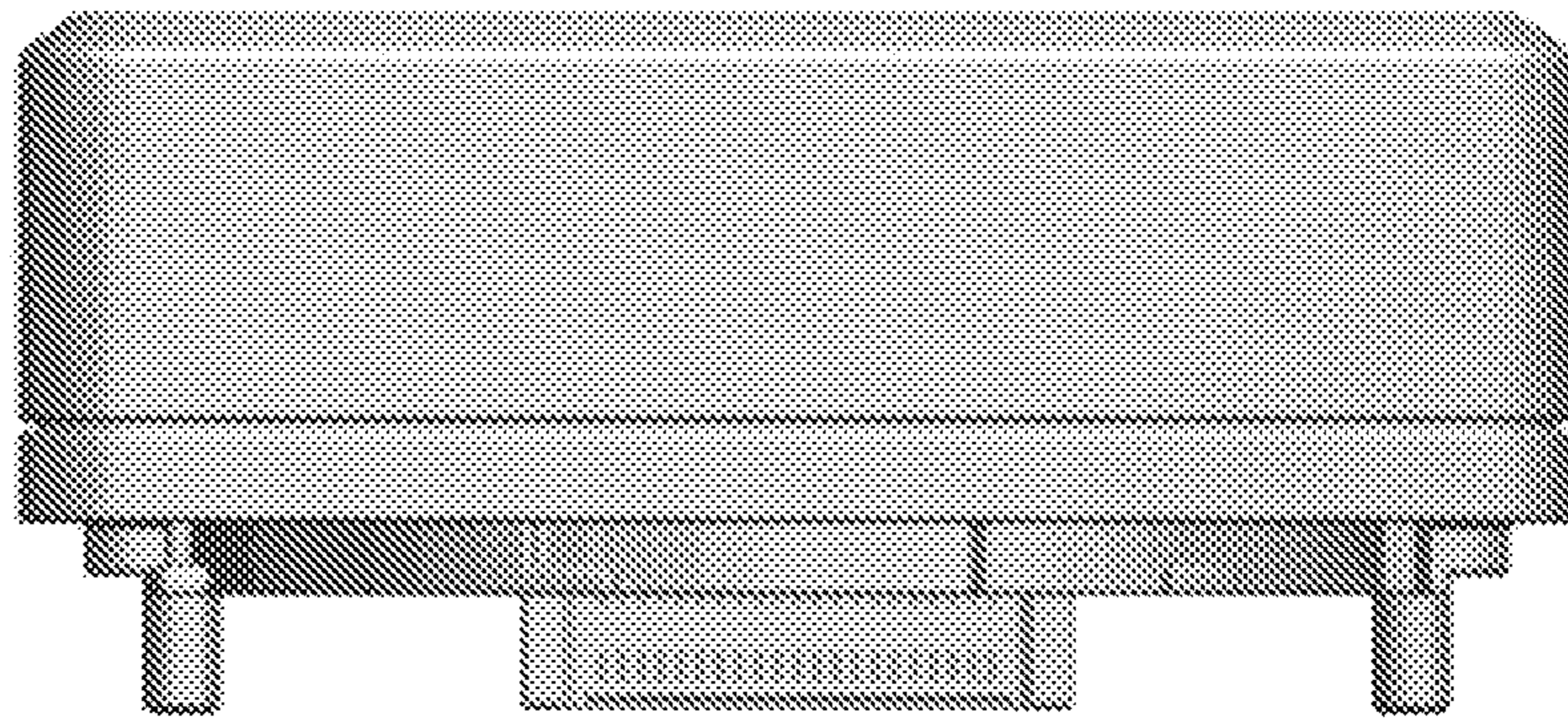

1.4

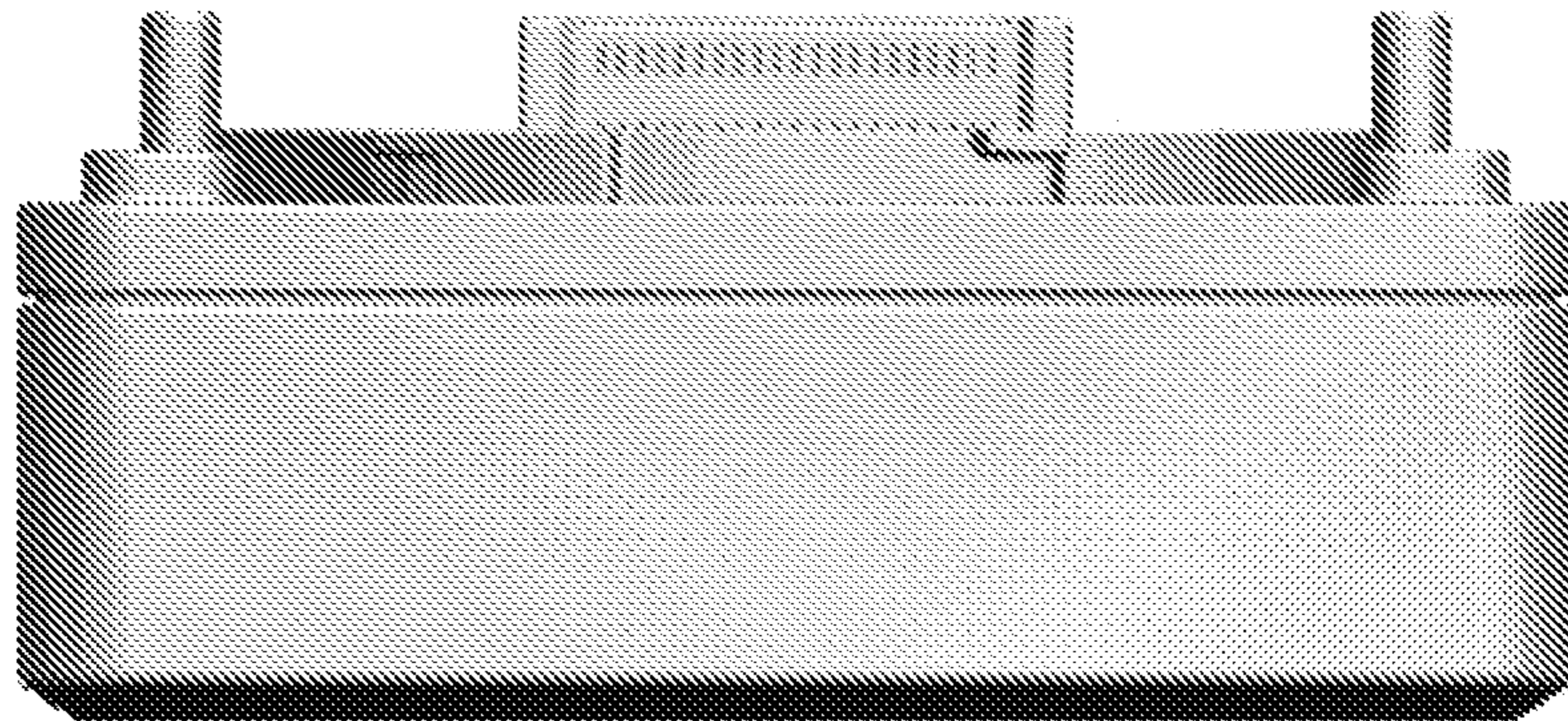

1.5

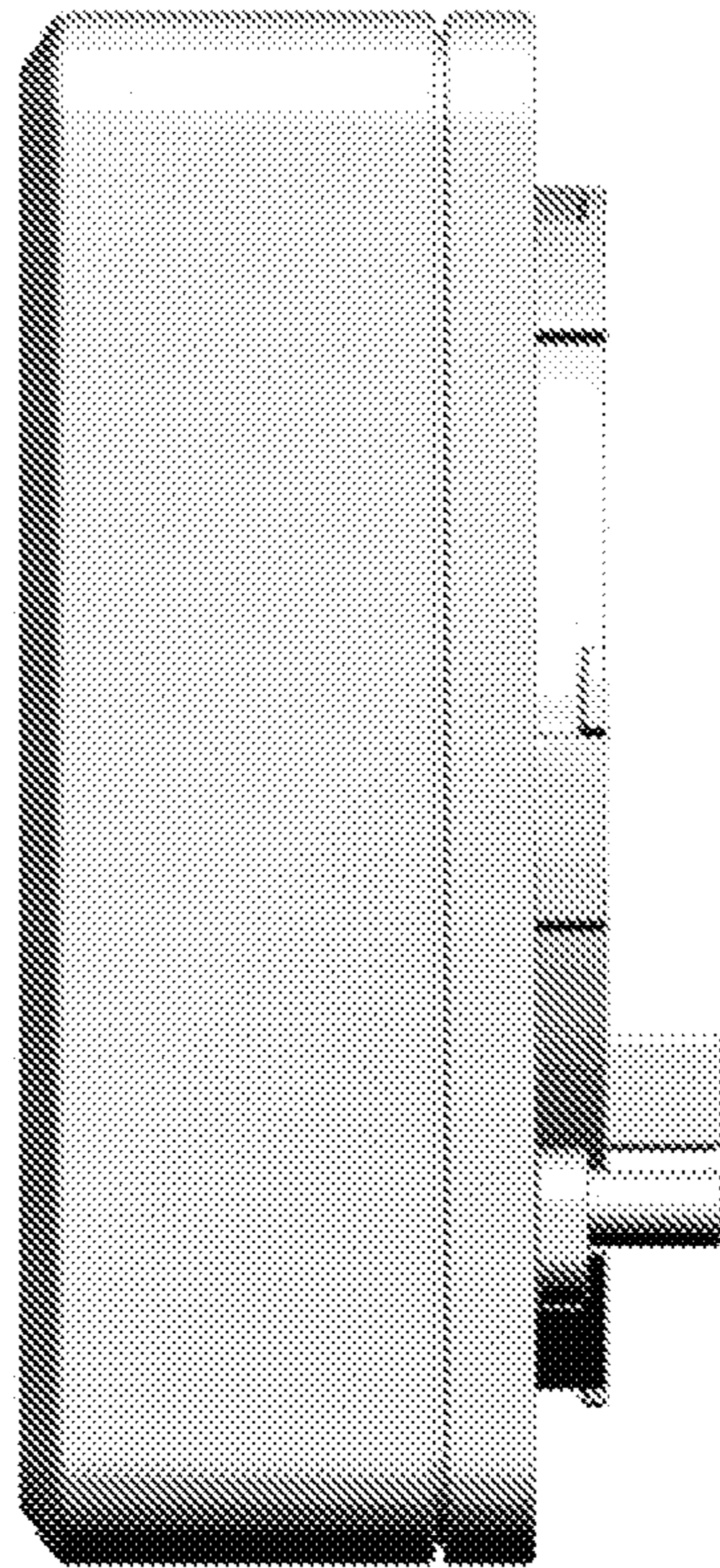

1.6

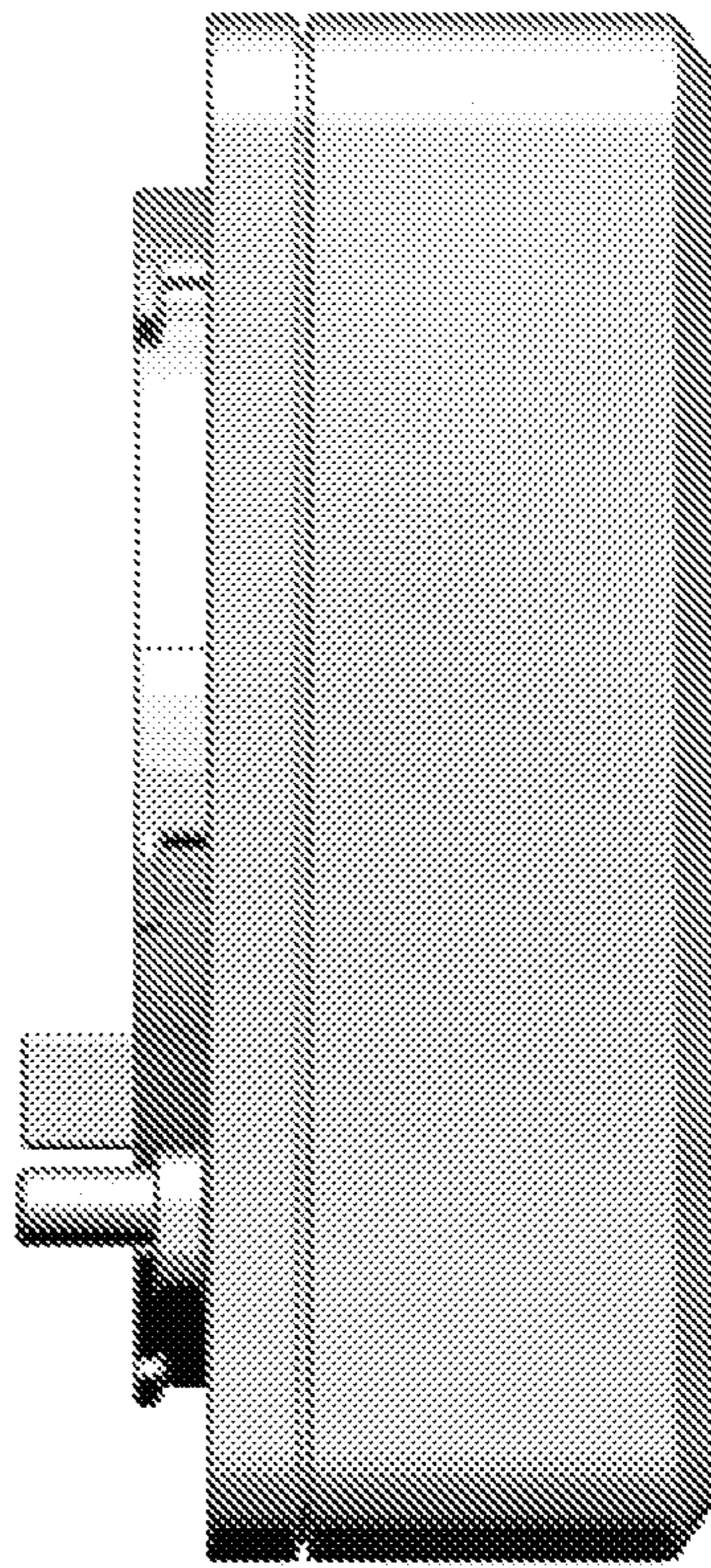

1.7

