



US00D873895S

(12) **United States Design Patent**  
**Costa et al.**

(10) **Patent No.:** **US D873,895 S**  
(45) **Date of Patent:** **\*\* Jan. 28, 2020**

- (54) **CAMERA COVER FOR ELECTRONIC DEVICE**
- (71) Applicant: **Facebook, Inc.**, Menlo Park, CA (US)
- (72) Inventors: **Mark Costa**, Menlo Park, CA (US);  
**Stefan Ahldor Kowalski**, Los Gatos, CA (US); **Blaise Bertrand**, San Francisco, CA (US)
- (73) Assignee: **Facebook, Inc.**, Menlo Park, CA (US)
- (\*\*) Term: **15 Years**
- (21) Appl. No.: **29/661,515**
- (22) Filed: **Aug. 28, 2018**
- (51) **LOC (12) Cl.** ..... **16-05**
- (52) **U.S. Cl.**  
USPC ..... **D16/237**
- (58) **Field of Classification Search**  
USPC ..... D16/219, 237-250; D8/354, 355, 363,  
D8/373, 382-383, 394-396; D14/224,  
D14/229, 238, 251, 447, 451, 457  
CPC ..... A45F 2200/0508-0533; A45F 5/00; A45F  
5/10; F16M 11/06-10; F16M 11/14;  
G02B 7/00-002; G03B 17/56; G03B  
17/561-568; H04N 5/2253-2254  
See application file for complete search history.

(56) **References Cited**

U.S. PATENT DOCUMENTS

D151,059 S *	9/1948	Main	.....	D3/321
D301,686 S *	6/1989	Long	.....	248/115
D339,535 S *	9/1993	Wilson	.....	D10/57
D610,901 S *	3/2010	Jones	.....	D8/394
D643,457 S *	8/2011	DeLong	.....	16/219
D672,223 S *	12/2012	Thompson	.....	D8/356
D714,852 S *	10/2014	Levesque	.....	D16/237
D718,803 S *	12/2014	Smith	.....	D16/250
D739,223 S *	9/2015	Paik	.....	D8/396
D764,474 S *	8/2016	Penn	.....	D14/440

D802,403 S *	11/2017	Weng	.....	D8/367
D808,457 S *	1/2018	Gustaveson, II	.....	D16/237
D812,453 S *	3/2018	Berger	.....	D8/367
D819,434 S *	6/2018	Sonneman	.....	D8/394
D821,184 S *	6/2018	Berger	.....	D8/367
D847,252 S *	4/2019	Stringham	.....	D17/20
2014/0220269 A1 *	8/2014	Ogufere Ogufere	...	B44C 5/005 428/34.1

OTHER PUBLICATIONS

Facebook-Portal-Camera-Cover. Published Oct. 8, 2018. Retrieved from URL: <http://kolomthota.com/facebook-launches-portal-auto-zooming-video-chat-screens-for-199-349/facebook-portal-camera-cover/>.\*

(Continued)

*Primary Examiner* — Vy N Koenig

(74) *Attorney, Agent, or Firm* — Baker Botts L.L.P.

(57) **CLAIM**

The ornamental design for a camera cover for electronic device, as shown and described.

**DESCRIPTION**

FIG. 1 is a front view of a camera cover for electronic device showing the new design;  
 FIG. 2 is a rear view thereof;  
 FIG. 3 is a top view thereof;  
 FIG. 4 is a bottom thereof;  
 FIG. 5 is a left view thereof;  
 FIG. 6 is a right view thereof;  
 FIG. 7 is a top left perspective view thereof;  
 FIG. 8 is a bottom left perspective view thereof; and,  
 FIG. 9 is a top right perspective view thereof showing the camera cover on an example electronic device for context purposes.  
 Illustrations in broken line show portions of the camera cover and the electronic device that form no part of the claimed design.

**1 Claim, 6 Drawing Sheets**

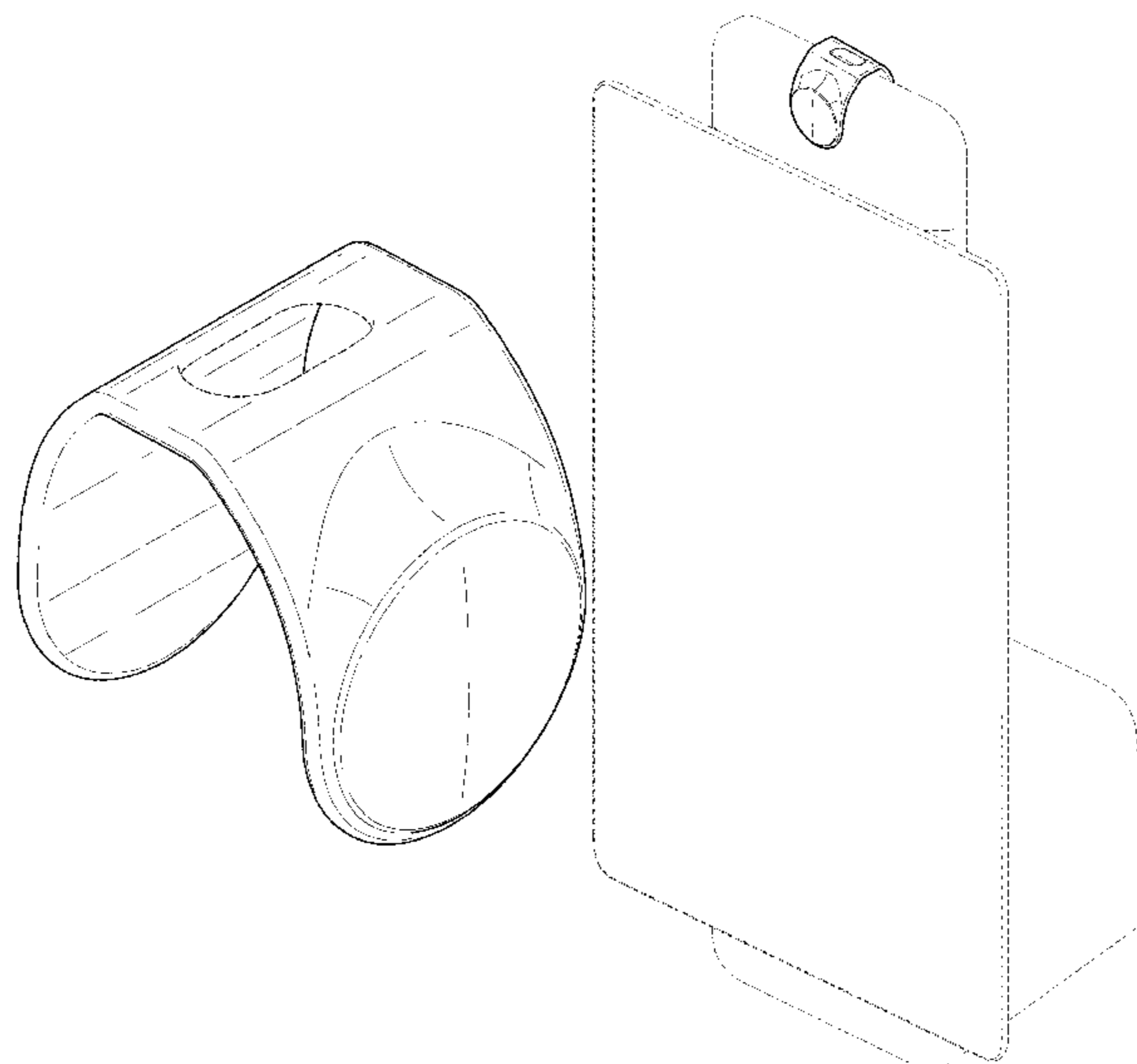

(56)

**References Cited**

OTHER PUBLICATIONS

Webcam Cover Joystick Maint. [online] Retrieved Aug. 15, 2019 from URL: <https://www.team-togs.com/webcam-cover-joystick-maint-sc00240295>.\*

Computer Camera Cover. [online] Retrieved Aug. 15, 2019 from URL: <https://www.shapeways.com/product/E3EVBHBVZ/f-k-the-nsa-computer-camera-cover-four-pack-r-rat?optionId=15806716>.\*

\* cited by examiner

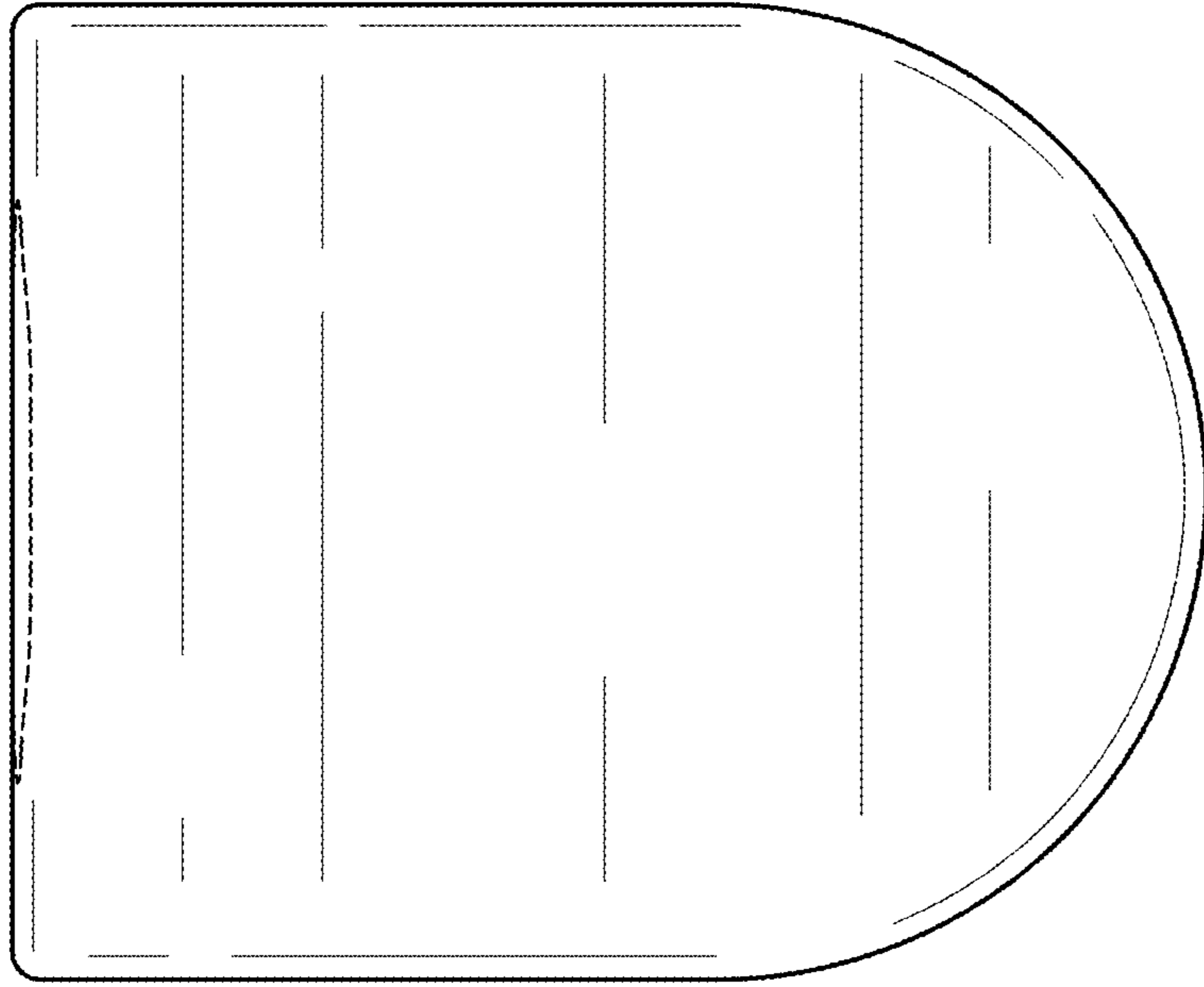

FIG. 1

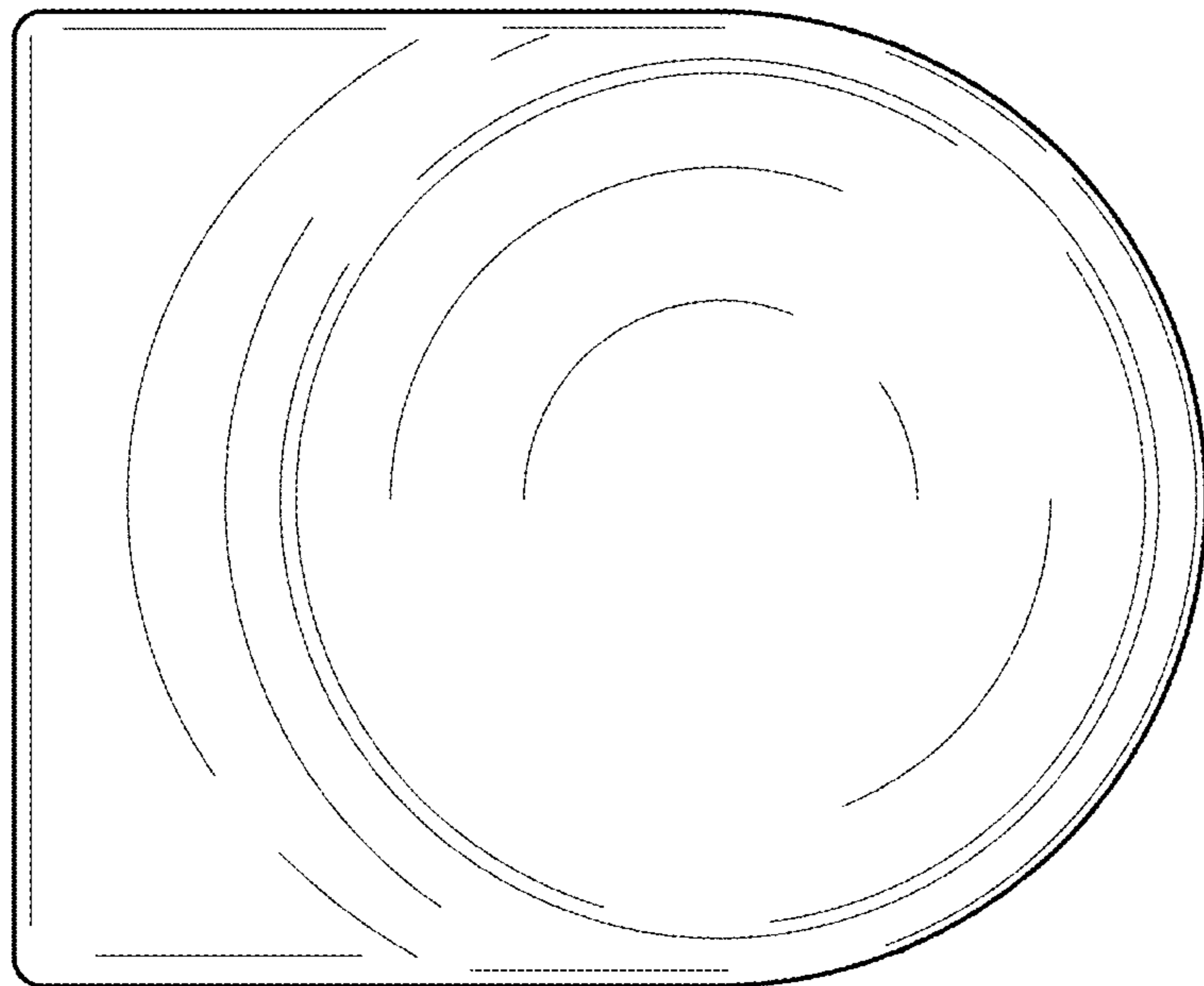

FIG. 2

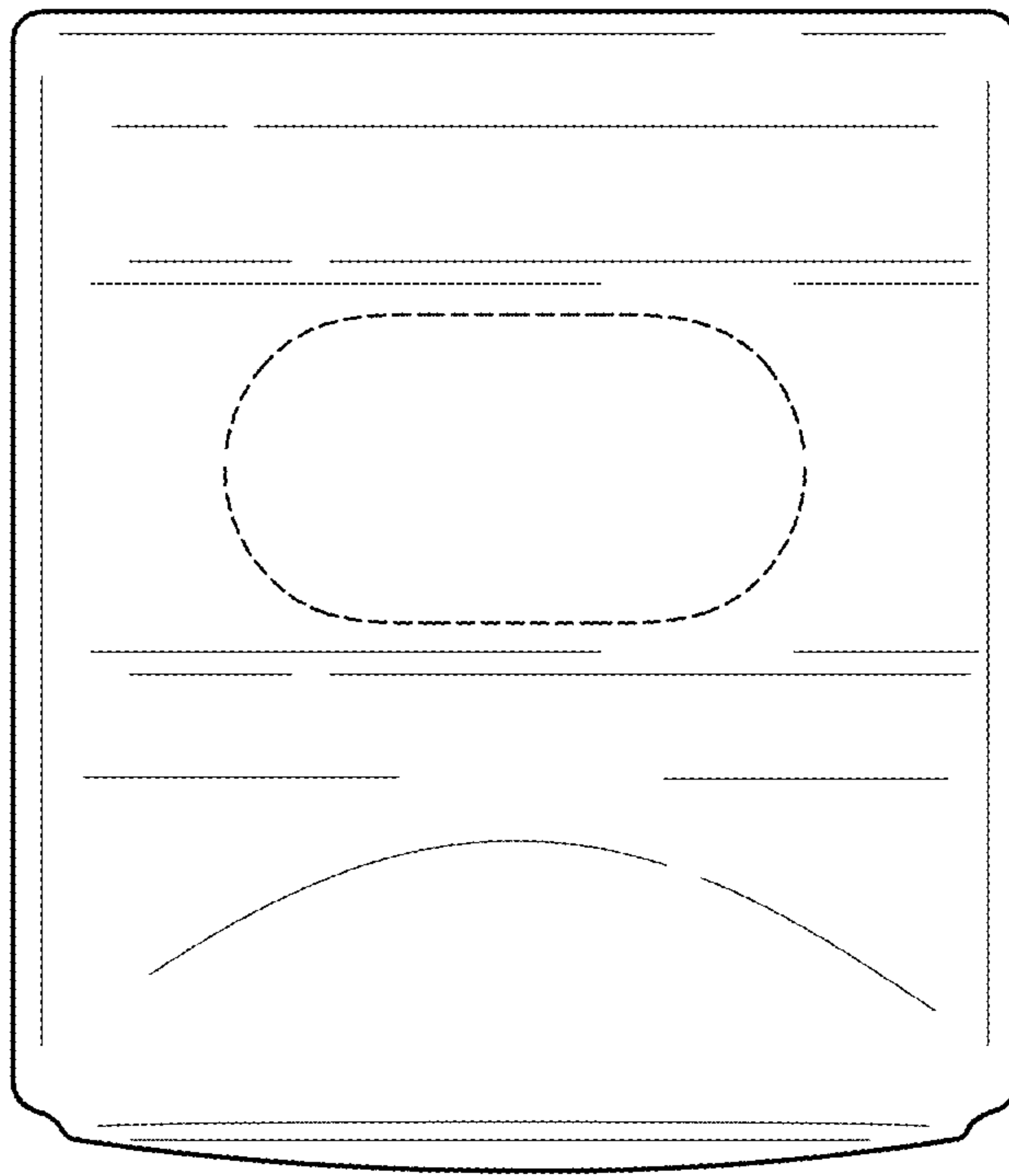

FIG. 3

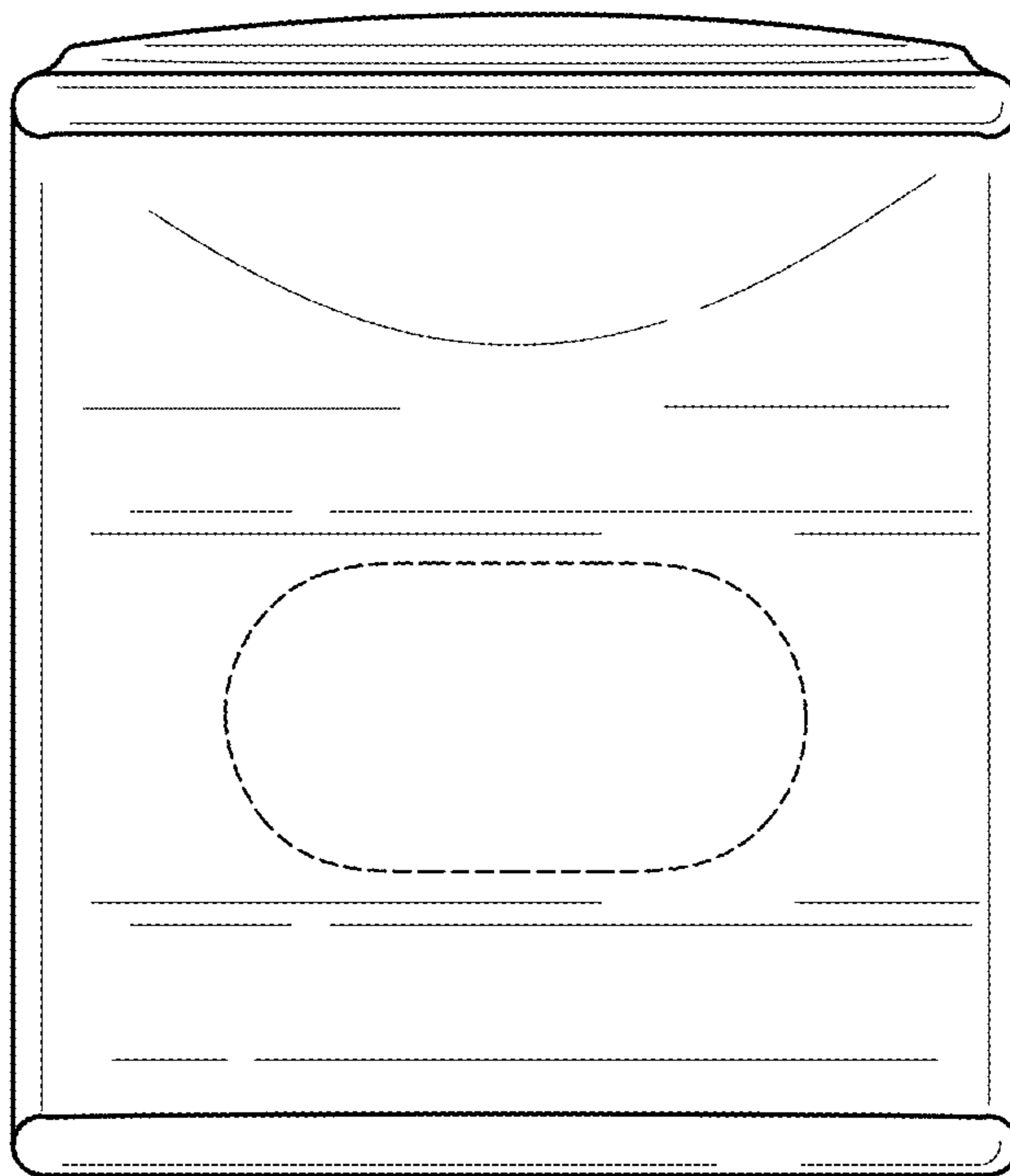

FIG. 4

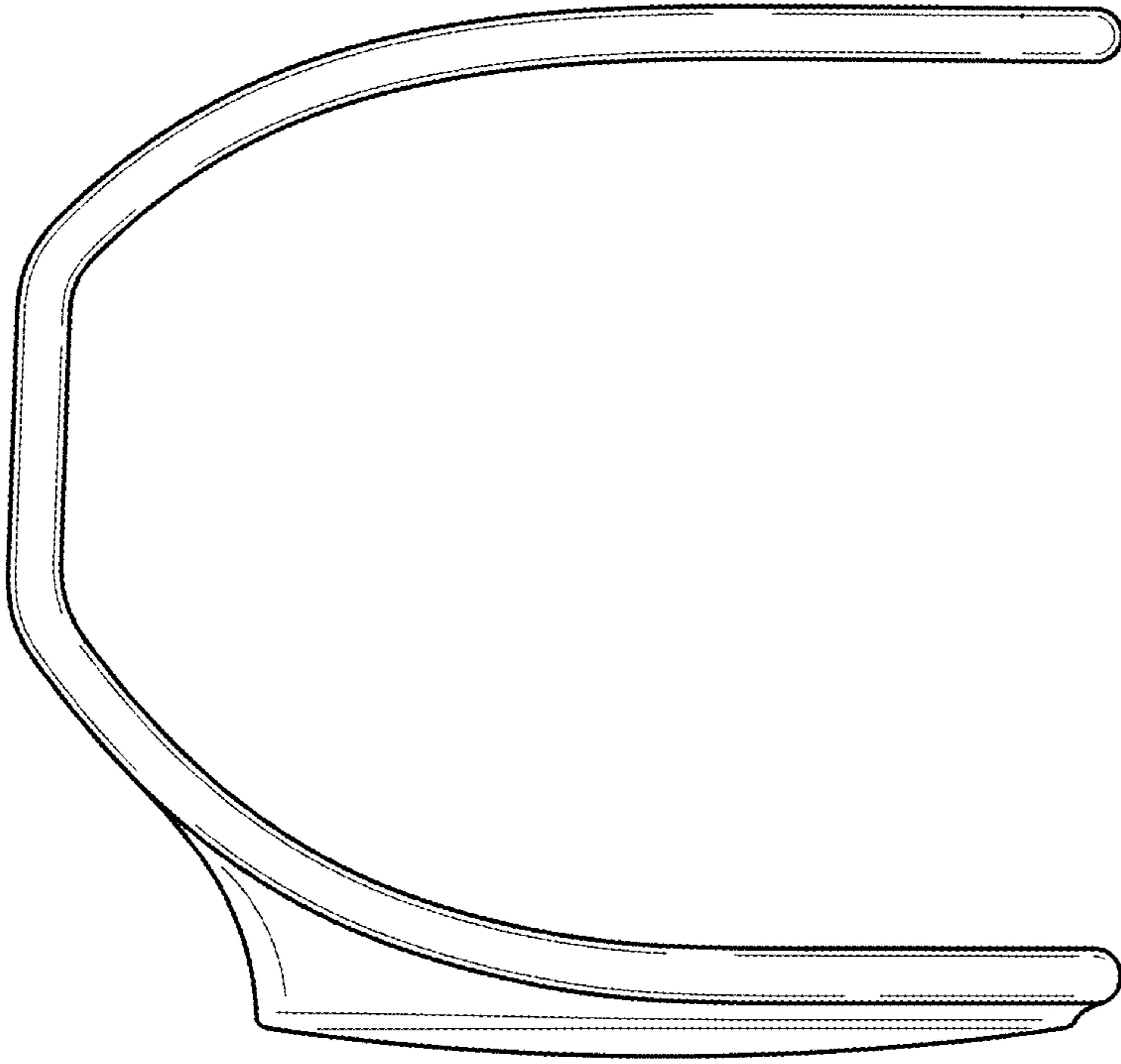

FIG. 6

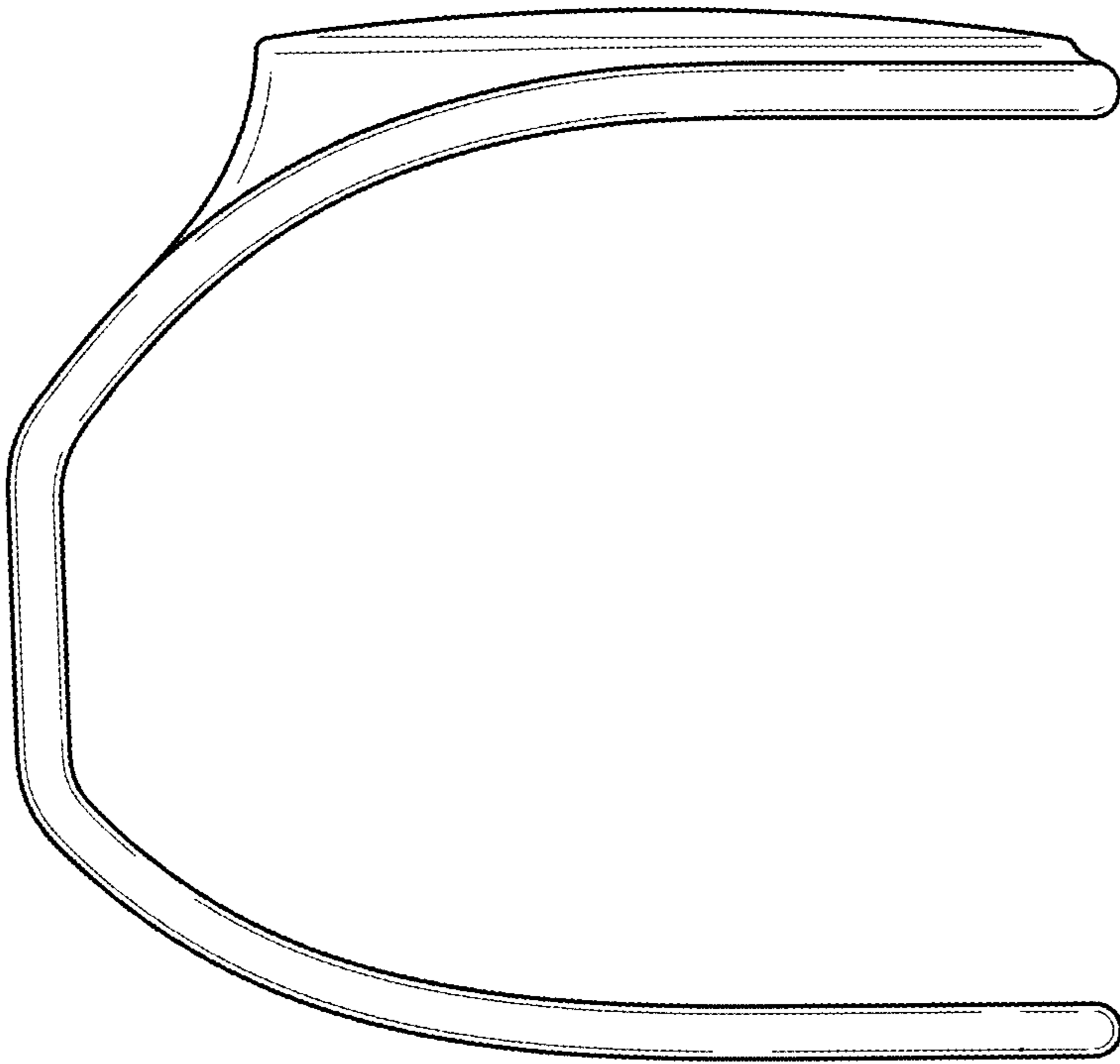

FIG. 5

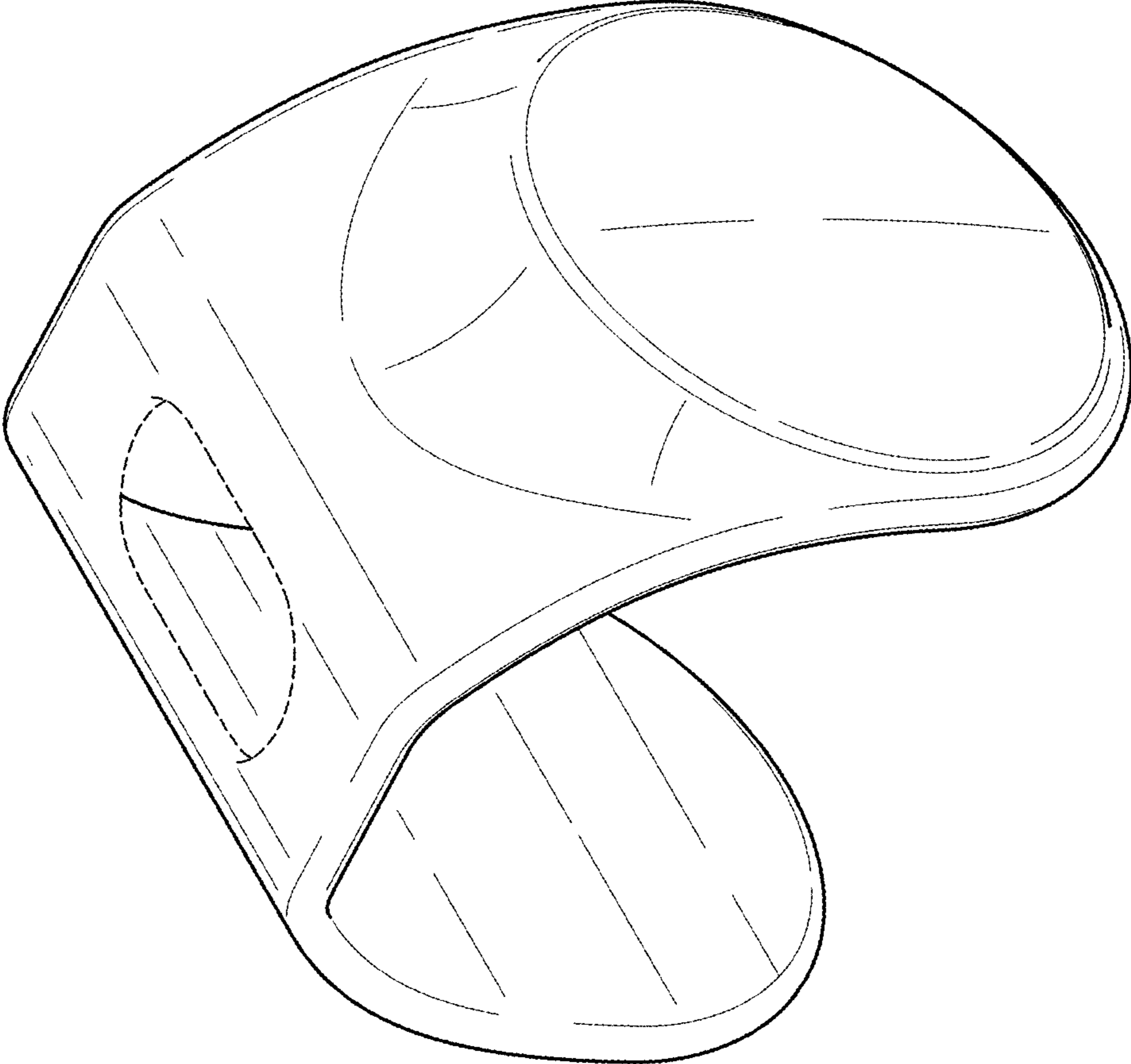

FIG.7

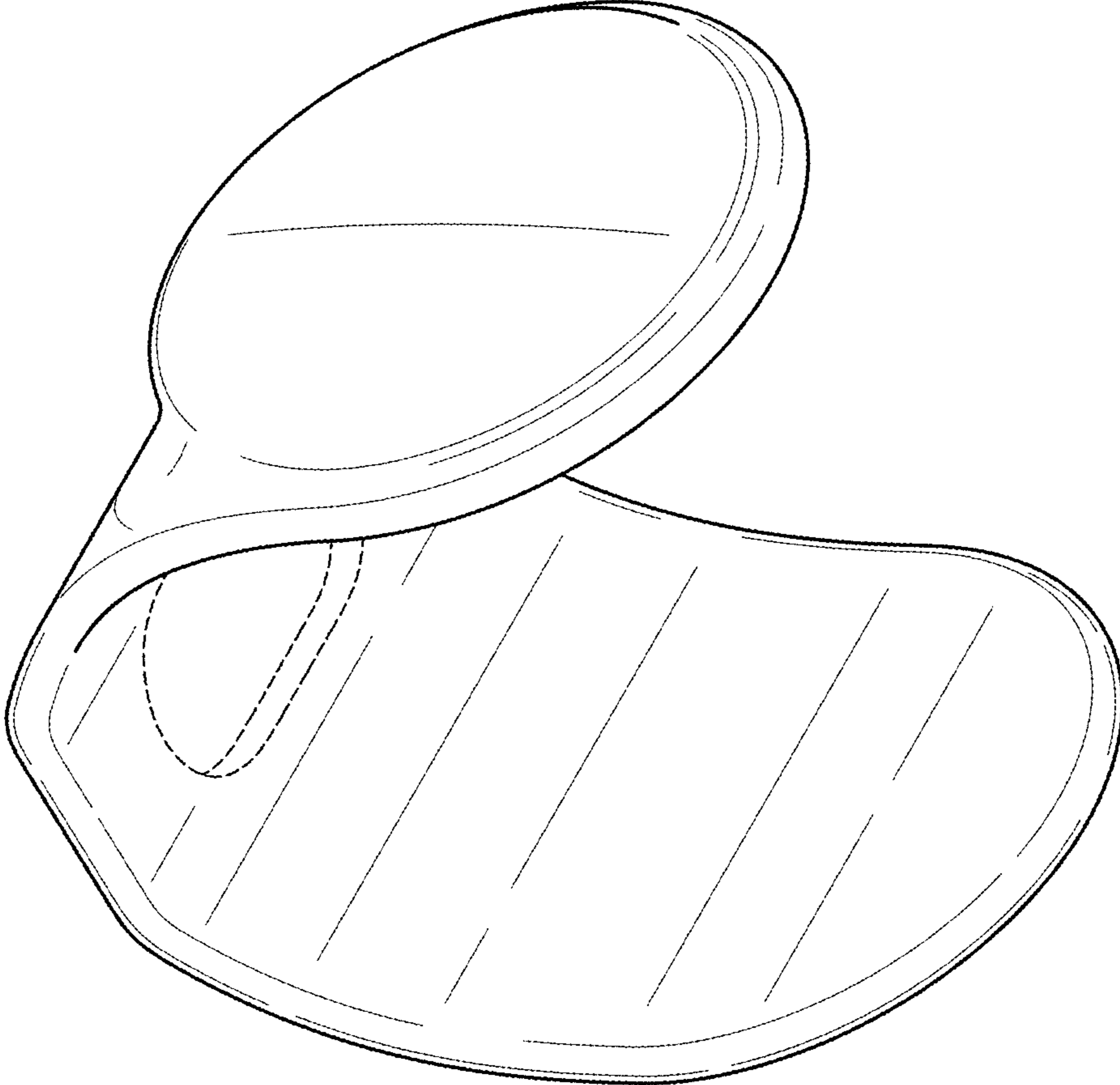
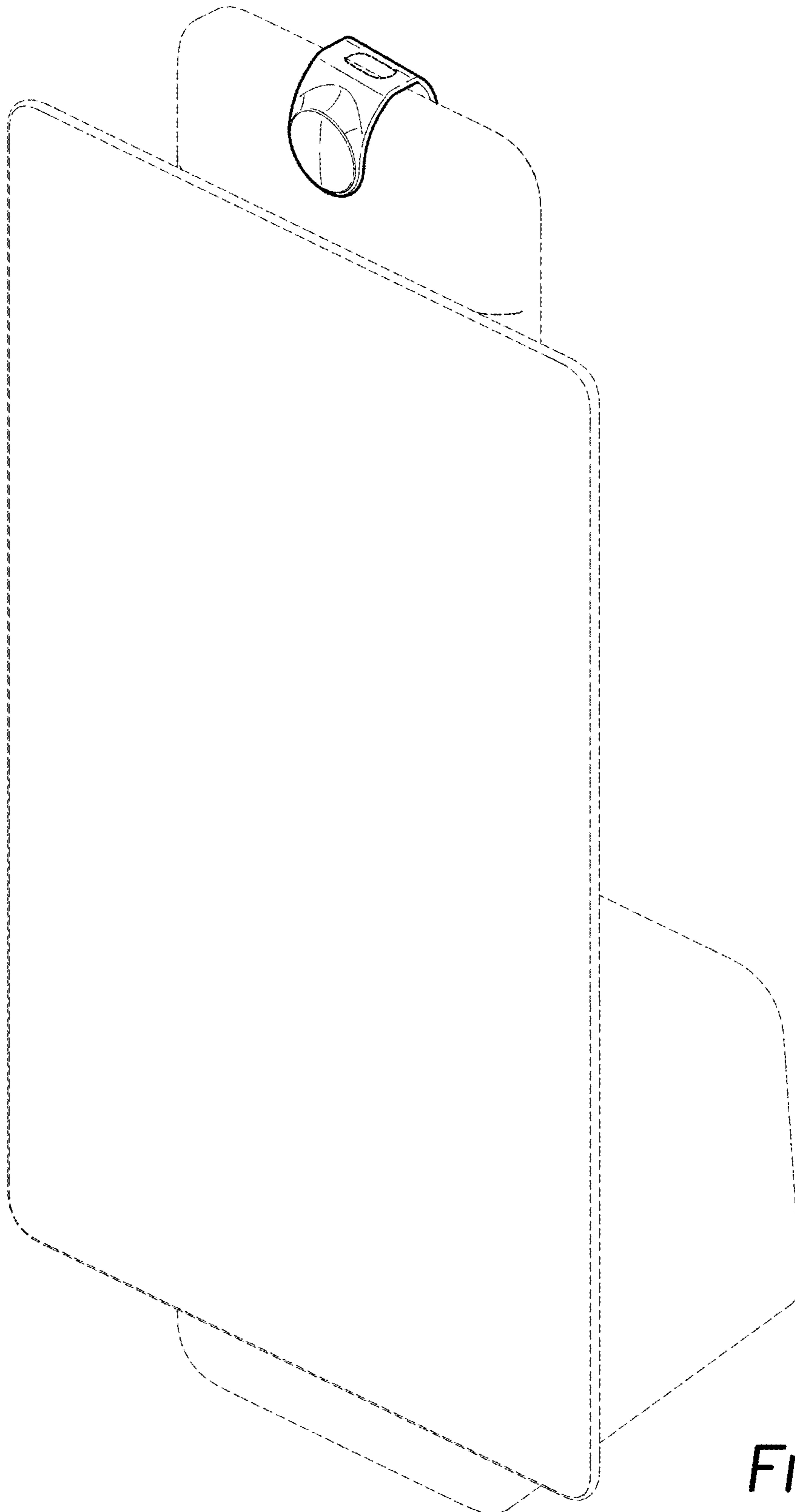

FIG.8



**FIG.9**